





OM-208 781A 2006-05

Effective with serial number 222 344

### Processes

-  MIG (GMAW) Welding
-  Flux Cored (FCAW) Welding

### Description



Arc Welding Power Source and Wire Feeder

CE

# Migmatic 171

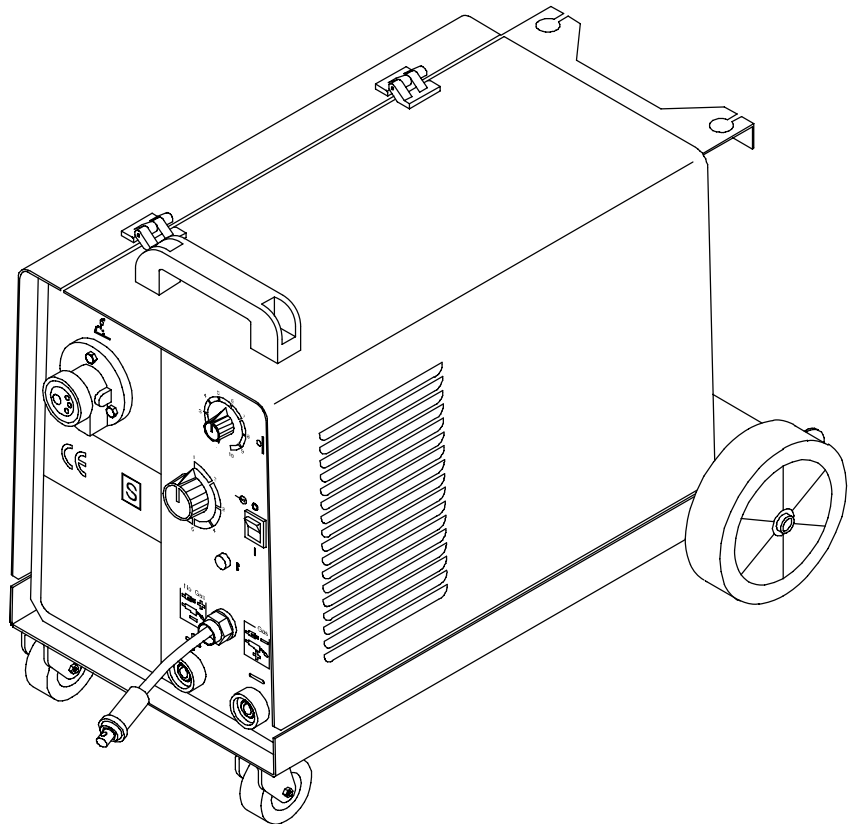

**OWNER'S MANUAL**

# From Miller to You

---

*Thank you and congratulations* on choosing Miller. Now you can get the job done and get it done right. We know you don't have time to do it any other way.

That's why when Niels Miller first started building arc welders in 1929, he made sure his products offered long-lasting value and superior quality. Like you, his customers couldn't afford anything less. Miller products had to be more than the best they could be. They had to be the best you could buy.

Today, the people that build and sell Miller products continue the tradition. They're just as committed to providing equipment and service that meets the high standards of quality and value established in 1929.

This Owner's Manual is designed to help you get the most out of your Miller products. Please take time to read the Safety precautions. They will help you protect yourself against potential hazards on the worksite. We've made installation and operation quick and easy. With Miller you can count on years of reliable service with proper maintenance. And if for some reason the unit needs repair, there's a Troubleshooting section that will help you figure out what the problem is. The parts list will then help you to decide which exact part you may need to fix the problem. Warranty and service information for your particular model are also provided.



Miller Electric manufactures a full line of welders and welding related equipment. For information on other quality Miller products, contact your local Miller distributor to receive the latest full line catalog or individual catalog sheets.



Working as hard as you do – every power source from Miller is backed by the most hassle-free warranty in the business.



# TABLE OF CONTENTS

---

<b>SECTION 1 – SAFETY PRECAUTIONS - READ BEFORE USING</b> .....	<b>1</b>
1-1. Symbol Usage .....	1
1-2. Arc Welding Hazards .....	1
1-3. Additional Symbols For Installation, Operation, And Maintenance .....	3
1-4. California Proposition 65 Warnings .....	3
1-5. Principal Safety Standards .....	4
1-6. EMF Information .....	4
<b>SECTION 2 – INSTALLATION</b> .....	<b>5</b>
2-1. Specifications .....	5
2-2. Duty Cycle and Overheating .....	5
2-3. Volt-Ampere Curves .....	6
2-4. Installing Gas Supply .....	6
2-5. Installing Drive Roll and Wire Inlet Guide .....	7
2-6. Electrical Service Guide .....	7
2-7. Selecting a Location and Connecting Input Power .....	8
<b>SECTION 3 – OPERATION</b> .....	<b>9</b>
3-1. Controls .....	9
<b>SECTION 4 – MAINTENANCE AND TROUBLESHOOTING</b> .....	<b>10</b>
4-1. Routine Maintenance .....	10
4-2. Unit Overload .....	10
4-3. Troubleshooting .....	11
<b>SECTION 5 – ELECTRICAL DIAGRAM</b> .....	<b>12</b>
<b>SECTION 6 – PARTS LIST</b> .....	<b>13</b>
<b>WARRANTY</b>	

# Declaration of Conformity for European Community (CE) Products

**NOTE**

*This information is provided for units with CE certification (see rating label on unit).*

**Manufacturer:**

ITW Welding Products Italy S.r.l.  
Via Privata Iseo 6/E  
20098 San Giuliano  
Milanese, Italy  
Phone: 39(02)98290-1

**European Contact:**

Mr. Danilo Fedolfi,  
Managing Director  
ITW Welding Products Italy S.r.l.  
Via Privata Iseo 6/E  
20098 San Giuliano  
Milanese, Italy  
Phone: 39(02)98290-1  
Fax: 39(02)98290203

European Contact Signature: \_\_\_\_\_

Declares that this product:

## Migmatic 171

conforms to the following Directives and Standards:

**Directives**

Low Voltage Directive: 73/23/EEC

Electromagnetic compatibility Directives: 89/336/EEC

Machinery Directives: 89/392/EEC

And their amendments 91/368/EEC, 92/31/EEC, 93/44/EEC, 93/68/EEC

**Standards**

Electromagnetic compatibility (EMC) Product standard for arc welding equipment: EN50199: August 1995

Safety requirements for Arc Welding Equipment Part 1: EN 60974-1: 1989

The product technical file is maintained by the responsible Business Unit(s) located at the manufacturing facility.

# SECTION 1 – SAFETY PRECAUTIONS - READ BEFORE USING

som\_3/05

▲ **Warning: Protect yourself and others from injury — read and follow these precautions.**

## 1-1. Symbol Usage



Means Warning! Watch Out! There are possible hazards with this procedure! The possible hazards are shown in the adjoining symbols.

▲ **Marks a special safety message.**

☞ Means "Note"; not safety related.



This group of symbols means Warning! Watch Out! possible ELECTRIC SHOCK, MOVING PARTS, and HOT PARTS hazards. Consult symbols and related instructions below for necessary actions to avoid the hazards.

## 1-2. Arc Welding Hazards

▲ **The symbols shown below are used throughout this manual to call attention to and identify possible hazards. When you see the symbol, watch out, and follow the related instructions to avoid the hazard. The safety information given below is only a summary of the more complete safety information found in the Safety Standards listed in Section 1-5. Read and follow all Safety Standards.**

▲ **Only qualified persons should install, operate, maintain, and repair this unit.**

▲ **During operation, keep everybody, especially children, away.**



### ELECTRIC SHOCK can kill.

Touching live electrical parts can cause fatal shocks or severe burns. The electrode and work circuit is electrically live whenever the output is on. The input power circuit and machine internal circuits are also

live when power is on. In semiautomatic or automatic wire welding, the wire, wire reel, drive roll housing, and all metal parts touching the welding wire are electrically live. Incorrectly installed or improperly grounded equipment is a hazard.

- Do not touch live electrical parts.
- Wear dry, hole-free insulating gloves and body protection.
- Insulate yourself from work and ground using dry insulating mats or covers big enough to prevent any physical contact with the work or ground.
- Do not use AC output in damp areas, if movement is confined, or if there is a danger of falling.
- Use AC output ONLY if required for the welding process.
- If AC output is required, use remote output control if present on unit.
- Additional safety precautions are required when any of the following electrically hazardous conditions are present: in damp locations or while wearing wet clothing; on metal structures such as floors, gratings, or scaffolds; when in cramped positions such as sitting, kneeling, or lying; or when there is a high risk of unavoidable or accidental contact with the workpiece or ground. For these conditions, use the following equipment in order presented: 1) a semiautomatic DC constant voltage (wire) welder, 2) a DC manual (stick) welder, or 3) an AC welder with reduced open-circuit voltage. In most situations, use of a DC, constant voltage wire welder is recommended. And, do not work alone!
- Disconnect input power or stop engine before installing or servicing this equipment. Lockout/tagout input power according to OSHA 29 CFR 1910.147 (see Safety Standards).
- Properly install and ground this equipment according to its Owner's Manual and national, state, and local codes.
- Always verify the supply ground – check and be sure that input power cord ground wire is properly connected to ground terminal in disconnect box or that cord plug is connected to a properly grounded receptacle outlet.
- When making input connections, attach proper grounding conductor first – double-check connections.
- Frequently inspect input power cord for damage or bare wiring – replace cord immediately if damaged – bare wiring can kill.

- Turn off all equipment when not in use.
- Do not use worn, damaged, undersized, or poorly spliced cables.
- Do not drape cables over your body.
- If earth grounding of the workpiece is required, ground it directly with a separate cable.
- Do not touch electrode if you are in contact with the work, ground, or another electrode from a different machine.
- Do not touch electrode holders connected to two welding machines at the same time since double open-circuit voltage will be present.
- Use only well-maintained equipment. Repair or replace damaged parts at once. Maintain unit according to manual.
- Wear a safety harness if working above floor level.
- Keep all panels and covers securely in place.
- Clamp work cable with good metal-to-metal contact to workpiece or worktable as near the weld as practical.
- Insulate work clamp when not connected to workpiece to prevent contact with any metal object.
- Do not connect more than one electrode or work cable to any single weld output terminal.

### SIGNIFICANT DC VOLTAGE exists in inverter-type welding power sources after removal of input power.

- Turn Off inverter, disconnect input power, and discharge input capacitors according to instructions in Maintenance Section before touching any parts.

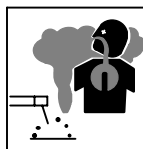

### FUMES AND GASES can be hazardous.

Welding produces fumes and gases. Breathing these fumes and gases can be hazardous to your health.

- Keep your head out of the fumes. Do not breathe the fumes.
- If inside, ventilate the area and/or use local forced ventilation at the arc to remove welding fumes and gases.
- If ventilation is poor, wear an approved air-supplied respirator.
- Read and understand the Material Safety Data Sheets (MSDSs) and the manufacturer's instructions for metals, consumables, coatings, cleaners, and degreasers.
- Work in a confined space only if it is well ventilated, or while wearing an air-supplied respirator. Always have a trained watch-person nearby. Welding fumes and gases can displace air and lower the oxygen level causing injury or death. Be sure the breathing air is safe.
- Do not weld in locations near degreasing, cleaning, or spraying operations. The heat and rays of the arc can react with vapors to form highly toxic and irritating gases.
- Do not weld on coated metals, such as galvanized, lead, or cadmium plated steel, unless the coating is removed from the weld area, the area is well ventilated, and while wearing an air-supplied respirator. The coatings and any metals containing these elements can give off toxic fumes if welded.



### **ARC RAYS can burn eyes and skin.**

Arc rays from the welding process produce intense visible and invisible (ultraviolet and infrared) rays that can burn eyes and skin. Sparks fly off from the weld.

- Wear an approved welding helmet fitted with a proper shade of filter lenses to protect your face and eyes when welding or watching (see ANSI Z49.1 and Z87.1 listed in Safety Standards).
- Wear approved safety glasses with side shields under your helmet.
- Use protective screens or barriers to protect others from flash, glare and sparks; warn others not to watch the arc.
- Wear protective clothing made from durable, flame-resistant material (leather, heavy cotton, or wool) and foot protection.



### **WELDING can cause fire or explosion.**

Welding on closed containers, such as tanks, drums, or pipes, can cause them to blow up. Sparks can fly off from the welding arc. The flying sparks, hot workpiece, and hot equipment can cause fires and burns. Accidental contact of electrode to metal objects can cause sparks, explosion, overheating, or fire. Check and be sure the area is safe before doing any welding.

- Remove all flammables within 35 ft (10.7 m) of the welding arc. If this is not possible, tightly cover them with approved covers.
- Do not weld where flying sparks can strike flammable material.
- Protect yourself and others from flying sparks and hot metal.
- Be alert that welding sparks and hot materials from welding can easily go through small cracks and openings to adjacent areas.
- Watch for fire, and keep a fire extinguisher nearby.
- Be aware that welding on a ceiling, floor, bulkhead, or partition can cause fire on the hidden side.
- Do not weld on closed containers such as tanks, drums, or pipes, unless they are properly prepared according to AWS F4.1 (see Safety Standards).
- Connect work cable to the work as close to the welding area as practical to prevent welding current from traveling long, possibly unknown paths and causing electric shock, sparks, and fire hazards.
- Do not use welder to thaw frozen pipes.
- Remove stick electrode from holder or cut off welding wire at contact tip when not in use.
- Wear oil-free protective garments such as leather gloves, heavy shirt, cuffless trousers, high shoes, and a cap.
- Remove any combustibles, such as a butane lighter or matches, from your person before doing any welding.
- Follow requirements in OSHA 1910.252 (a) (2) (iv) and NFPA 51B for hot work and have a fire watcher and extinguisher nearby.

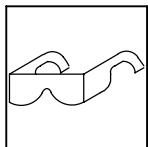

### **FLYING METAL can injure eyes.**

- Welding, chipping, wire brushing, and grinding cause sparks and flying metal. As welds cool, they can throw off slag.
- Wear approved safety glasses with side shields even under your welding helmet.



### **BUILDUP OF GAS can injure or kill.**

- Shut off shielding gas supply when not in use.
- Always ventilate confined spaces or use approved air-supplied respirator.



### **HOT PARTS can cause severe burns.**

- Do not touch hot parts bare handed.
- Allow cooling period before working on gun or torch.
- To handle hot parts, use proper tools and/or wear heavy, insulated welding gloves and clothing to prevent burns.



### **MAGNETIC FIELDS can affect pacemakers.**

- Pacemaker wearers keep away.
- Wearers should consult their doctor before going near arc welding, gouging, or spot welding operations.



### **NOISE can damage hearing.**

Noise from some processes or equipment can damage hearing.

- Wear approved ear protection if noise level is high.



### **CYLINDERS can explode if damaged.**

Shielding gas cylinders contain gas under high pressure. If damaged, a cylinder can explode. Since gas cylinders are normally part of the welding process, be sure to treat them carefully.

- Protect compressed gas cylinders from excessive heat, mechanical shocks, physical damage, slag, open flames, sparks, and arcs.
- Install cylinders in an upright position by securing to a stationary support or cylinder rack to prevent falling or tipping.
- Keep cylinders away from any welding or other electrical circuits.
- Never drape a welding torch over a gas cylinder.
- Never allow a welding electrode to touch any cylinder.
- Never weld on a pressurized cylinder – explosion will result.
- Use only correct shielding gas cylinders, regulators, hoses, and fittings designed for the specific application; maintain them and associated parts in good condition.
- Turn face away from valve outlet when opening cylinder valve.
- Keep protective cap in place over valve except when cylinder is in use or connected for use.
- Use the right equipment, correct procedures, and sufficient number of persons to lift and move cylinders.
- Read and follow instructions on compressed gas cylinders, associated equipment, and Compressed Gas Association (CGA) publication P-1 listed in Safety Standards.

## 1-3. Additional Symbols For Installation, Operation, And Maintenance



### FIRE OR EXPLOSION hazard.

- Do not install or place unit on, over, or near combustible surfaces.
- Do not install unit near flammables.
- Do not overload building wiring – be sure power supply system is properly sized, rated, and protected to handle this unit.



### FALLING UNIT can cause injury.

- Use lifting eye to lift unit only, NOT running gear, gas cylinders, or any other accessories.
- Use equipment of adequate capacity to lift and support unit.
- If using lift forks to move unit, be sure forks are long enough to extend beyond opposite side of unit.



### OVERUSE can cause OVERHEATING

- Allow cooling period; follow rated duty cycle.
- Reduce current or reduce duty cycle before starting to weld again.
- Do not block or filter airflow to unit.



### STATIC (ESD) can damage PC boards.

- Put on grounded wrist strap BEFORE handling boards or parts.
- Use proper static-proof bags and boxes to store, move, or ship PC boards.



### MOVING PARTS can cause injury.

- Keep away from moving parts.
- Keep away from pinch points such as drive rolls.



### WELDING WIRE can cause injury.

- Do not press gun trigger until instructed to do so.
- Do not point gun toward any part of the body, other people, or any metal when threading welding wire.



### MOVING PARTS can cause injury.

- Keep away from moving parts such as fans.
- Keep all doors, panels, covers, and guards closed and securely in place.
- Have only qualified persons remove doors, panels, covers, or guards for maintenance as necessary.
- Reinstall doors, panels, covers, or guards when maintenance is finished and before re-connecting input power.



### READ INSTRUCTIONS.

- Read Owner's Manual before using or servicing unit.
- Use only genuine Miller/Hobart replacement parts.

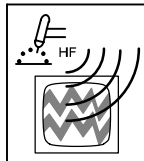

### H.F. RADIATION can cause interference.

- High-frequency (H.F.) can interfere with radio navigation, safety services, computers, and communications equipment.
- Have only qualified persons familiar with electronic equipment perform this installation.
- The user is responsible for having a qualified electrician promptly correct any interference problem resulting from the installation.
- If notified by the FCC about interference, stop using the equipment at once.
- Have the installation regularly checked and maintained.
- Keep high-frequency source doors and panels tightly shut, keep spark gaps at correct setting, and use grounding and shielding to minimize the possibility of interference.



### ARC WELDING can cause interference.

- Electromagnetic energy can interfere with sensitive electronic equipment such as computers and computer-driven equipment such as robots.
- Be sure all equipment in the welding area is electromagnetically compatible.
- To reduce possible interference, keep weld cables as short as possible, close together, and down low, such as on the floor.
- Locate welding operation 100 meters from any sensitive electronic equipment.
- Be sure this welding machine is installed and grounded according to this manual.
- If interference still occurs, the user must take extra measures such as moving the welding machine, using shielded cables, using line filters, or shielding the work area.

## 1-4. California Proposition 65 Warnings

- ▲ **Welding or cutting equipment produces fumes or gases which contain chemicals known to the State of California to cause birth defects and, in some cases, cancer. (California Health & Safety Code Section 25249.5 et seq.)**
- ▲ **Battery posts, terminals and related accessories contain lead and lead compounds, chemicals known to the State of California to cause cancer and birth defects or other reproductive harm. Wash hands after handling.**

### For Gasoline Engines:

- ▲ **Engine exhaust contains chemicals known to the State of California to cause cancer, birth defects, or other reproductive harm.**

### For Diesel Engines:

- ▲ **Diesel engine exhaust and some of its constituents are known to the State of California to cause cancer, birth defects, and other reproductive harm.**

## 1-5. Principal Safety Standards

*Safety in Welding, Cutting, and Allied Processes*, ANSI Standard Z49.1, from Global Engineering Documents (phone: 1-877-413-5184, website: www.global.ihs.com).

*Recommended Safe Practices for the Preparation for Welding and Cutting of Containers and Piping*, American Welding Society Standard AWS F4.1 from Global Engineering Documents (phone: 1-877-413-5184, website: www.global.ihs.com).

*National Electrical Code*, NFPA Standard 70, from National Fire Protection Association, P.O. Box 9101, 1 Battery March Park, Quincy, MA 02269-9101 (phone: 617-770-3000, website: www.nfpa.org).

*Safe Handling of Compressed Gases in Cylinders*, CGA Pamphlet P-1, from Compressed Gas Association, 1735 Jefferson Davis Highway, Suite 1004, Arlington, VA 22202-4102 (phone: 703-412-0900, website: www.cganet.com).

*Code for Safety in Welding and Cutting*, CSA Standard W117.2, from Canadian Standards Association, Standards Sales, 178 Rexdale

Boulevard, Rexdale, Ontario, Canada M9W 1R3 (phone: 800-463-6727 or in Toronto 416-747-4044, website: www.csa-international.org).

*Practice For Occupational And Educational Eye And Face Protection*, ANSI Standard Z87.1, from American National Standards Institute, 11 West 42nd Street, New York, NY 10036-8002 (phone: 212-642-4900, website: www.ansi.org).

*Standard for Fire Prevention During Welding, Cutting, and Other Hot Work*, NFPA Standard 51B, from National Fire Protection Association, P.O. Box 9101, 1 Battery March Park, Quincy, MA 02269-9101 (phone: 617-770-3000, website: www.nfpa.org).

OSHA, Occupational Safety and Health Standards for General Industry, Title 29, Code of Federal Regulations (CFR), Part 1910, Subpart Q, and Part 1926, Subpart J, from U.S. Government Printing Office, Superintendent of Documents, P.O. Box 371954, Pittsburgh, PA 15250 (there are 10 Regional Offices--phone for Region 5, Chicago, is 312-353-2220, website: www.osha.gov).

## 1-6. EMF Information

Considerations About Welding And The Effects Of Low Frequency Electric And Magnetic Fields

Welding current, as it flows through welding cables, will cause electromagnetic fields. There has been and still is some concern about such fields. However, after examining more than 500 studies spanning 17 years of research, a special blue ribbon committee of the National Research Council concluded that: "The body of evidence, in the committee's judgment, has not demonstrated that exposure to power-frequency electric and magnetic fields is a human-health hazard." However, studies are still going forth and evidence continues to be examined. Until the final conclusions of the research are reached, you may wish to minimize your exposure to electromagnetic fields when welding or cutting.

To reduce magnetic fields in the workplace, use the following procedures:

1. Keep cables close together by twisting or taping them.
2. Arrange cables to one side and away from the operator.
3. Do not coil or drape cables around your body.
4. Keep welding power source and cables as far away from operator as practical.
5. Connect work clamp to workpiece as close to the weld as possible.

### **About Pacemakers:**

Pacemaker wearers consult your doctor before welding or going near welding operations. If cleared by your doctor, then following the above procedures is recommended.



# SECTION 2 – INSTALLATION



## 2-1. Specifications

Model	Rated Output			Max. Open Circuit Voltage	Rated Input Amperage at Rated Output	Dimension (mm)	Weight (kg)
	100%	60%	30%		230 V		
171	70 A 17,5 V	100 A 19 V	150 A 21,5 V	34	25A 2A*	300 x 400 x 510	33

Wire feed speed range 1,8 mpm to 18 mpm.

\* While idling

## 2-2. Duty Cycle and Overheating

Rated Output

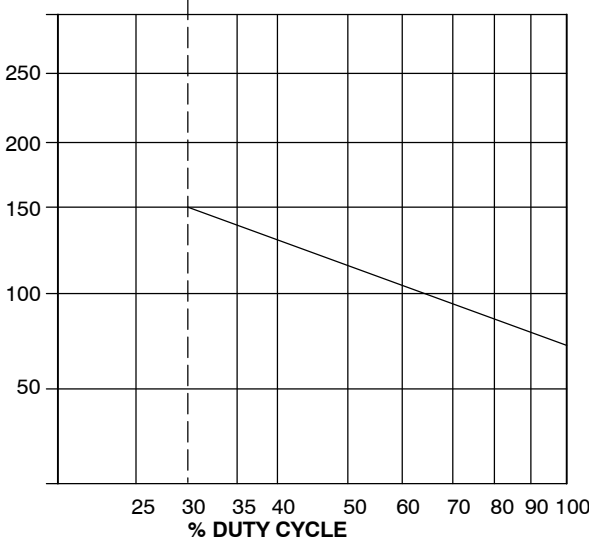

Duty Cycle is a percentage of 10 minutes that unit can weld at rated load without overheating.

If unit overheats, thermostat(s) opens, output stops, and cooling fan runs. Wait fifteen minutes for unit to cool. Reduce amperage or voltage, or duty cycle before welding.

**▲ Exceeding duty cycle can damage unit and void warranty.**

60% Duty Cycle at 200 Amperes

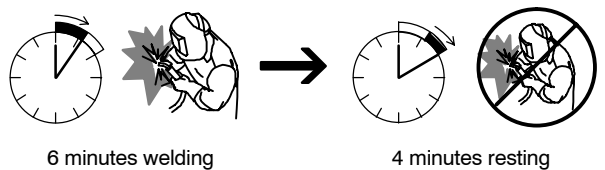

6 minutes welding      4 minutes resting

40% Duty Cycle at 250 Amperes

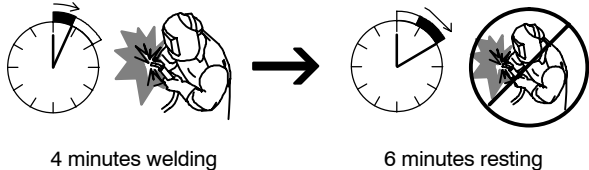

4 minutes welding      6 minutes resting

**Overheating**

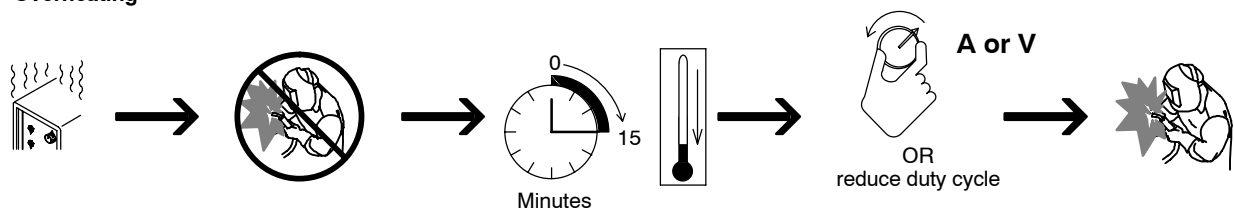

Minutes

A or V  
OR  
reduce duty cycle

duty1 4/95 – SB-150 215

## 2-3. Volt-Ampere Curves

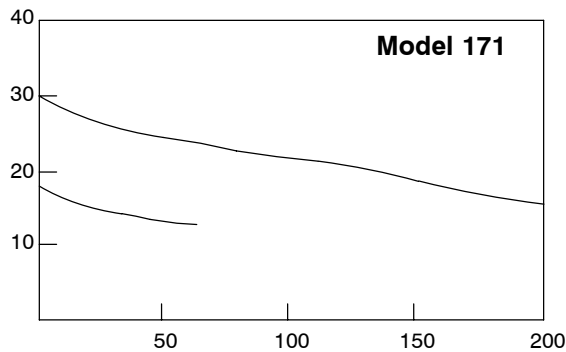

### 1 Normal Volt-Amperage Curves

The volt-ampere curves show the normal minimum and maximum voltage and amperage output capabilities of the welding power source. Curves of other settings fall between the curves shown.

### 2 Overload Volt-Amperage Curves

When unit is beyond capacity, circuitry senses the overload and shuts down unit output. Release trigger and lower weld voltage setting before trying to weld. This shut down circuitry protects internal circuits and parts from overload damage.

## 2-4. Installing Gas Supply

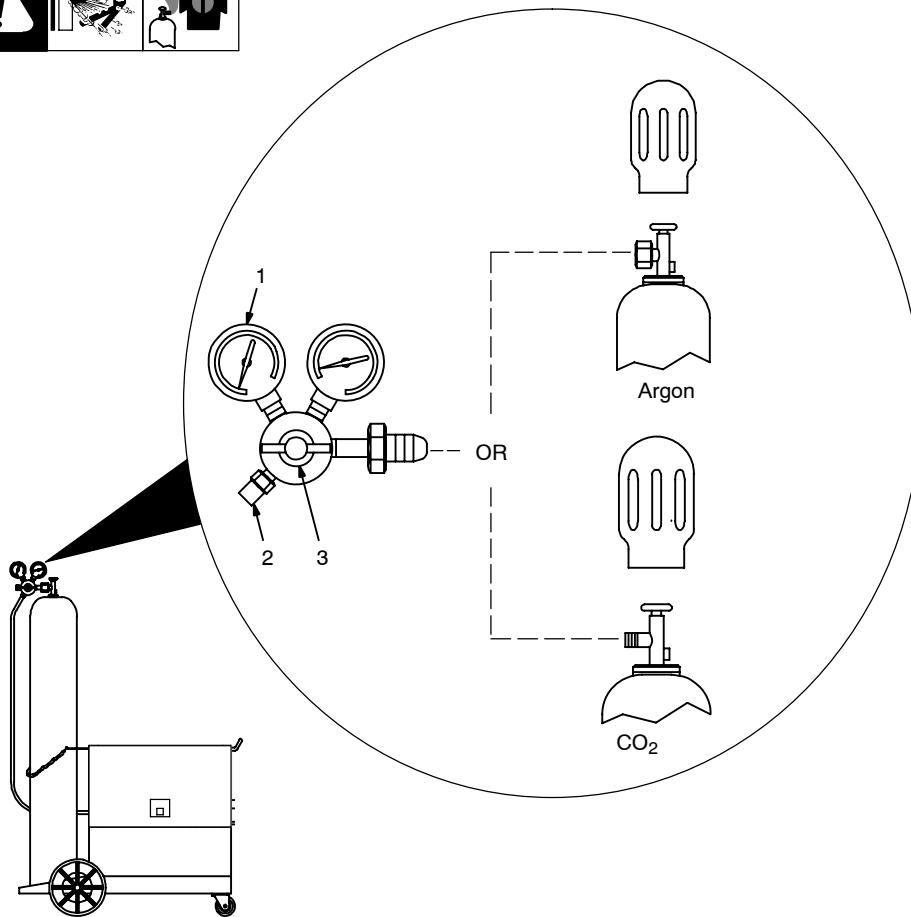

Chain gas cylinder to running gear, wall, or other stationary support so cylinder cannot fall and break off valve.

### 1 Regulator/Flow Gauge

Install so face is vertical.

### 2 Gas Hose Connection

### 3 Flow Adjust

Typical flow rate is 20 cfh (cubic feet per hour). Check wire manufacturer's recommended flow rate. This flow gauge can be adjusted between 5 and 25 cfh.

Ref. ST-148 265-B / Ref. ST-149 827-B / Ref. ST-158 697-A

## 2-5. Installing Drive Roll and Wire Inlet Guide

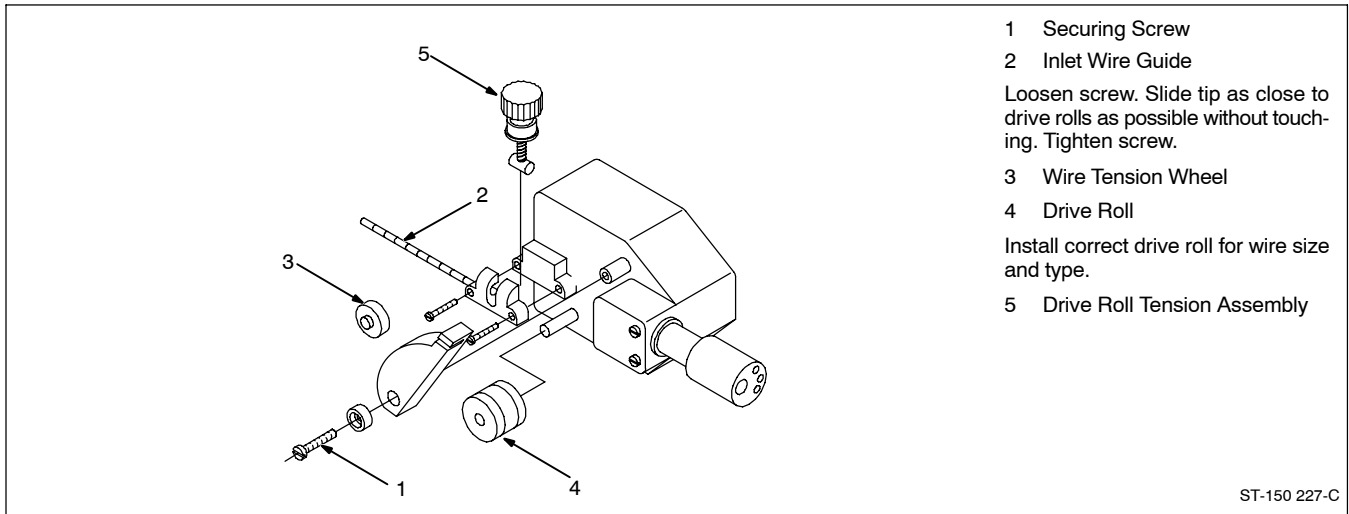

## 2-6. Electrical Service Guide

	171
<b>Input Voltage</b>	230
<b>Input Amperes at Rated Output</b>	25
<b>Max Recommended Standard Fuse or Circuit Breaker rating in Amperes</b>	25
<b>** Input Conductor Size in mm<sup>2</sup></b>	4
<b>** Grounding Conductor Size in mm<sup>2</sup></b>	4
** Power cord supplied with the unit is sized for 230V operation. Larger power cord may be required for cable lengths greater than 3 meters. Consult national and local regulations.	

## 2-7. Selecting a Location and Connecting Input Power

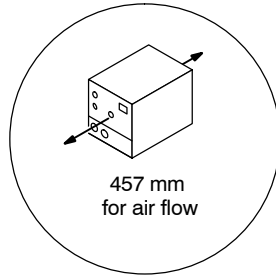

457 mm  
for air flow

Have only qualified persons make this installation.

1 Rating Label

Supply correct input power.

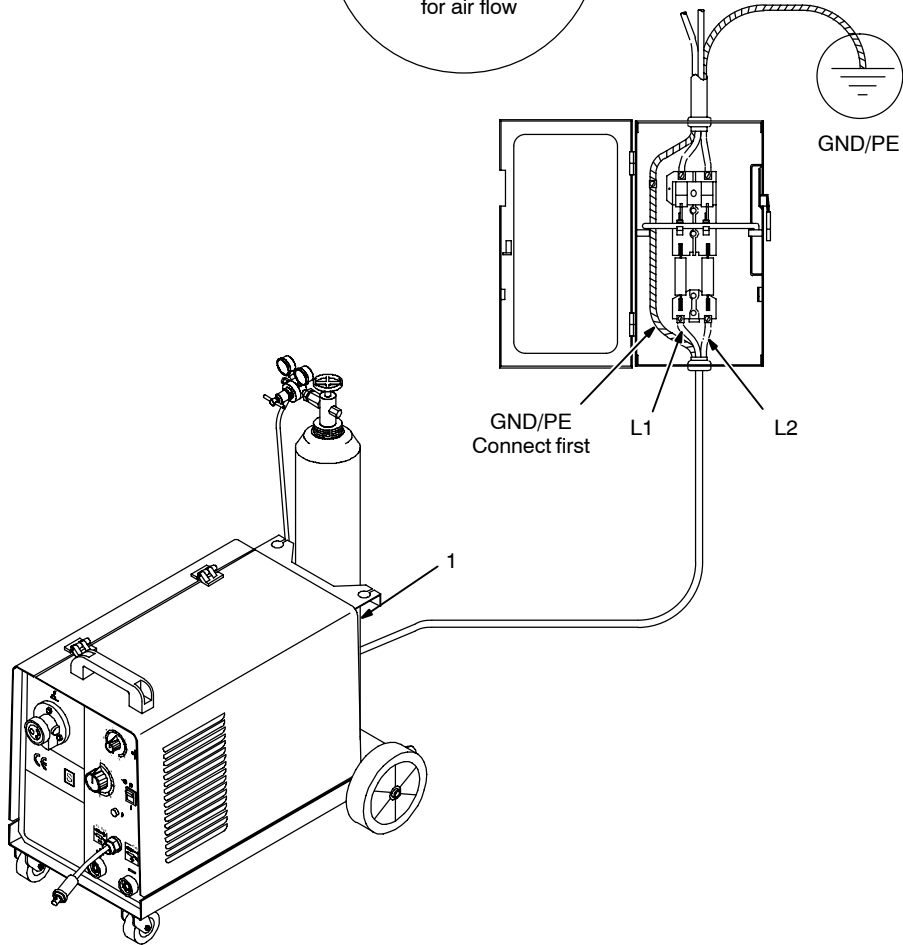

ST-801 721

# SECTION 3 – OPERATION

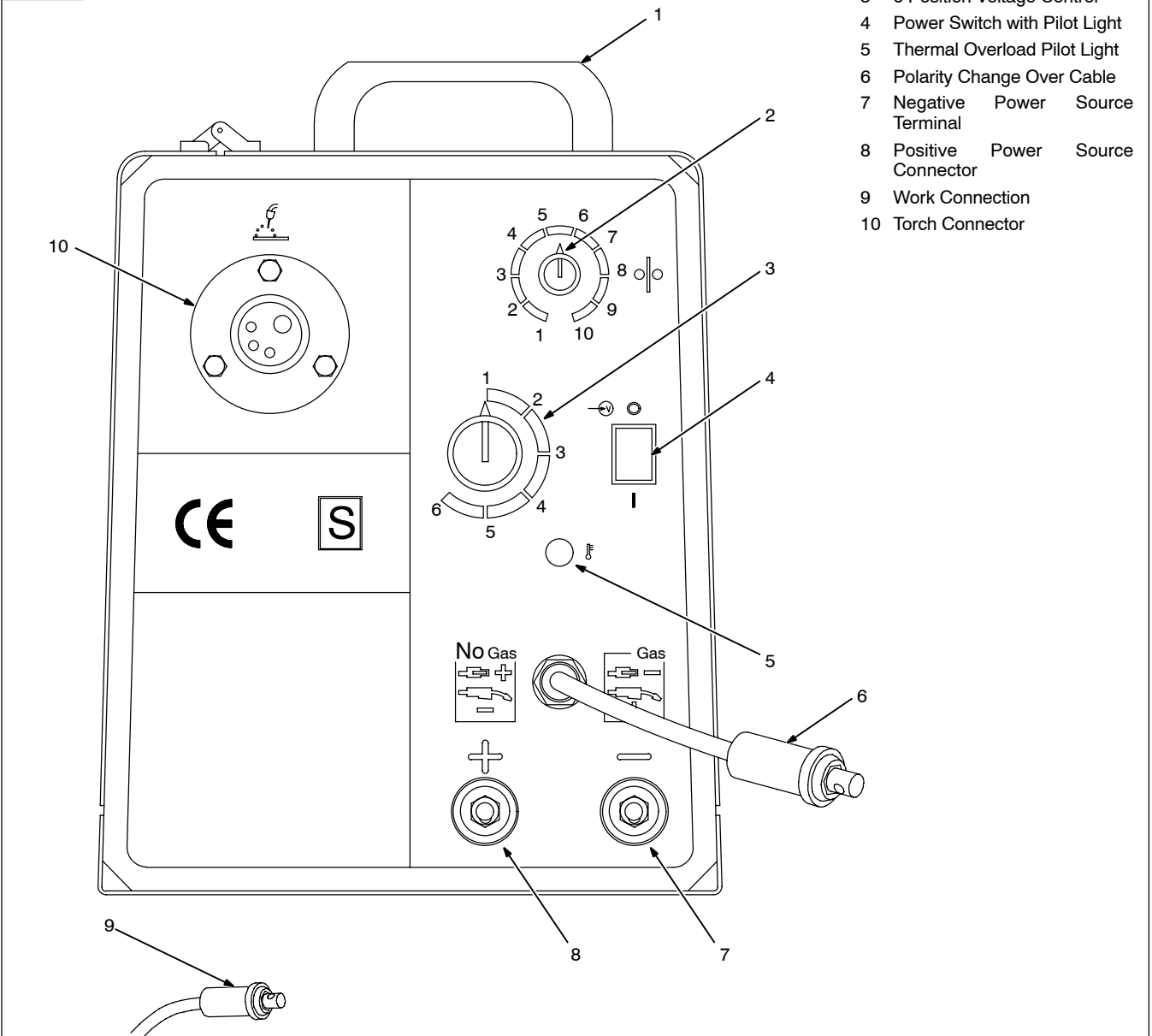

## 3-1. Controls





- 1 Handle
- 2 Wire Speed Control
- 3 6 Position Voltage Control
- 4 Power Switch with Pilot Light
- 5 Thermal Overload Pilot Light
- 6 Polarity Change Over Cable
- 7 Negative Power Source Terminal
- 8 Positive Power Source Connector
- 9 Work Connection
- 10 Torch Connector

# SECTION 4 – MAINTENANCE AND TROUBLESHOOTING

## 4-1. Routine Maintenance

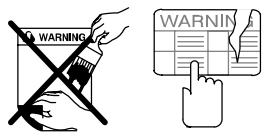
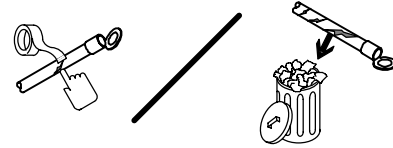
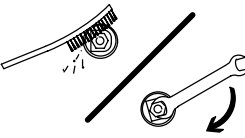
			<b>▲ Disconnect power before maintaining.</b>
---	---	---	---

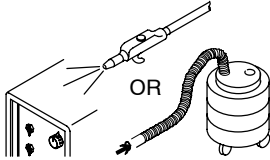
	<b>3 Months</b>	<p>Replace unreadable labels.</p> 	<p>Repair or replace cracked weld cables.</p> 
		<p>Clean and tighten weld terminals.</p> 	
	<b>6 Months</b>	<p>Blow out or vacuum inside. During heavy service clean monthly.</p> 	

## 4-2. Unit Overload

If unit is beyond capacity (excessive wire feed, shorted output, etc.) wire feeds but is not energized. Release gun trigger to reset this condition.

## 4-3. Troubleshooting



Trouble	Remedy
No weld output; wire does not feed.	Be sure line disconnect switch is On (see Section 2-7).
	Replace building line fuse or reset circuit breaker if open(see Section 2-7).
	Reset circuit-breaker CB1.
	Secure gun trigger connections.
	Check and replace Power switch if necessary
No weld output; overload light on	Thermostat TP1 open (overheating). Allow fan to run; the thermostat will close when the unit has cooled (see Section 2-2).
	An overload condition occurred. Release gun trigger (see Section 4-2).
Low weld output.	Connect unit to proper input voltage or check for low line voltage (see Section 2-7).
No wire feed.	Reset circuit-breaker CB1.
	Turn Wire Speed control to higher setting (see Section 3-1).
	Clear obstruction in gun contact tip or liner.
	Readjust drive roll pressure.
	Change to correct size drive rolls (see Section 2-5).
	Check gun trigger and leads. Repair or replace gun if necessary.
Poor weld bead, or welding wire is noodle welding.	Check polarity setting for type of welding wire being used.

# SECTION 5 – ELECTRICAL DIAGRAM

## 5-1. Migmatic 171

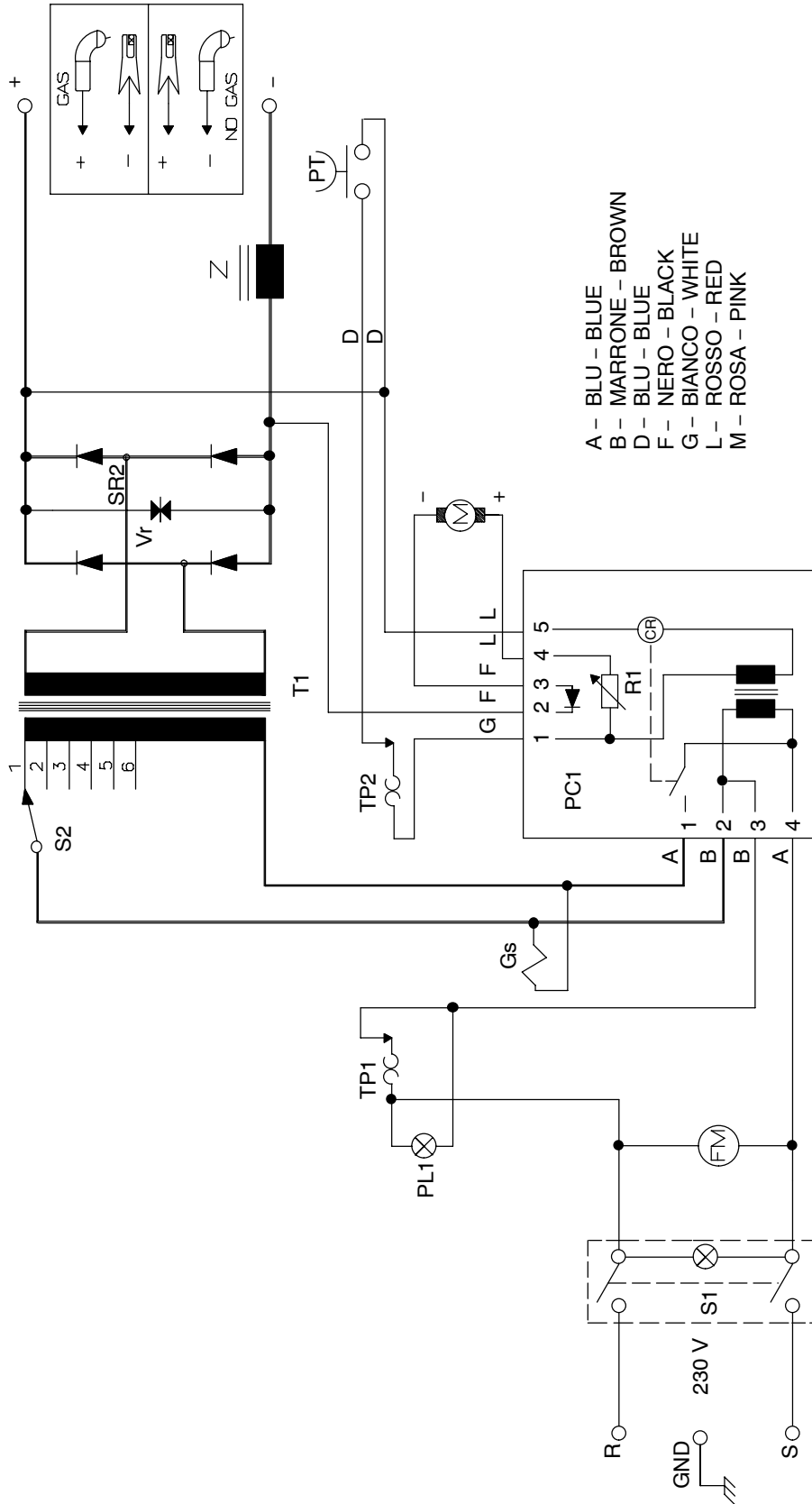

MU/sf - 2



# SECTION 6 – PARTS LIST

## 6-1. Main Assembly

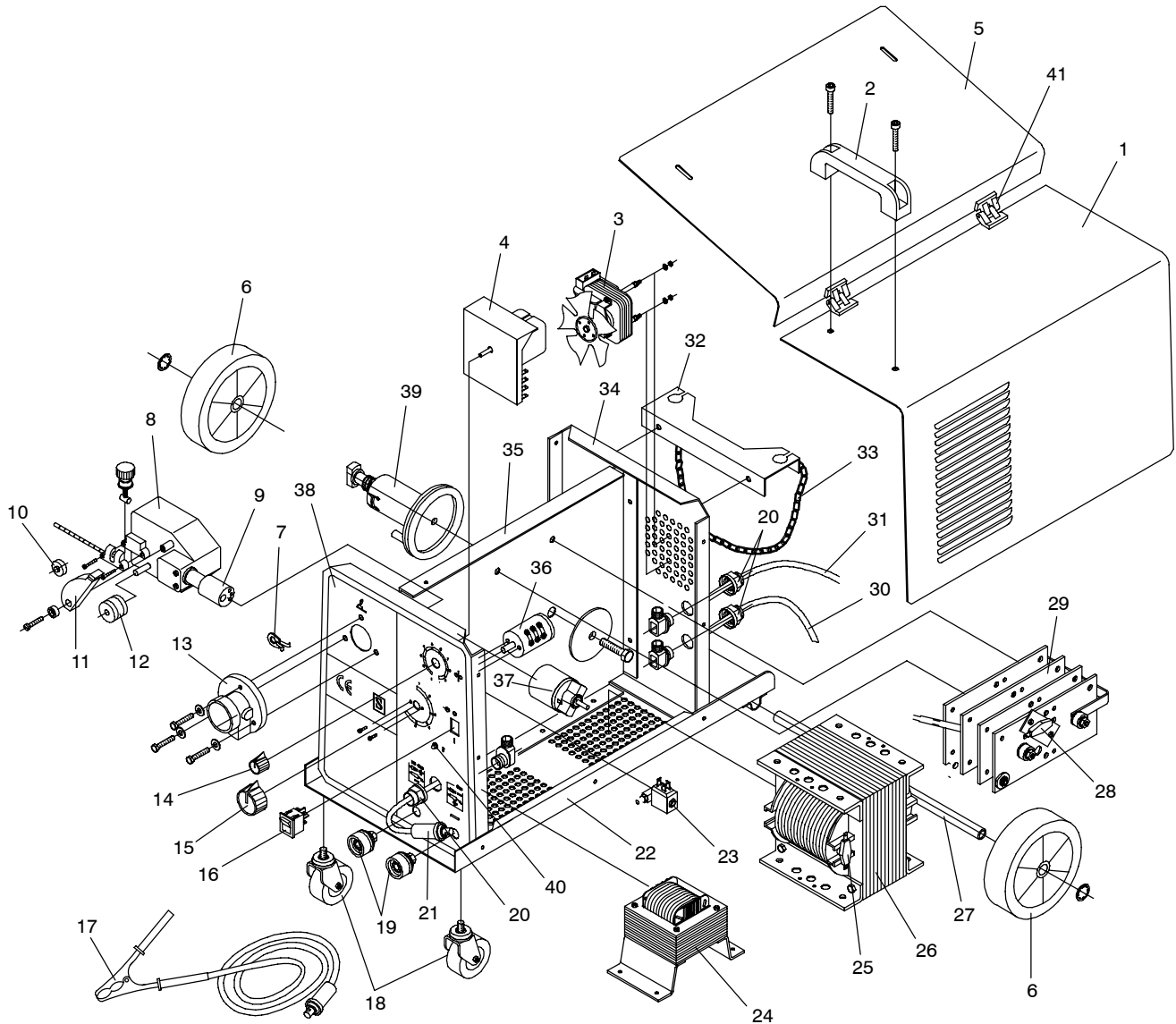

Item	Dia Ref.	Code	Dwg	Qty.	Item	Dia Ref.	Code	Dwg	Qty.
1		156022018	VP.0.0.24	1	21		056076199	MU.0.0.40	1
2		656002010	MU.0.0.22	1	22		156006009	VP.0.0.30	1
3	FM230V-50/60Hz	057035005		1	23	GS.230V	056061037	MQ.0.0.5	1
4	PC1	057084040	MU.0.1	1	24	Z	057098011	VQ.0.2	1
5		156007028	VP.0.0.25	1	25	TP.1	056159006	MU.0.0.10	1
6		056054076	MU.0.0.56	2	26	T1 (230V-1PH-50/60Hz	058021053	MU.1	1
7		056063003	VR.0.0.19	1	27		156012121	MU.0.0.55	1
8	Feed-Roll-Plate	057021016	MU.0.11	1	28	TP2	056159005	MQ.0.0.3	1
9		057052013	MU.0.9	1	29	SR.2	056050112	MU.0.0.18	1
10		156017151	MU.0.0.48	1	30		256071005	MU.0.0.24	1
11		656002012	MU.0.0.36	1	31	5 x 10,5	656026035	MU.0.0.15	1
12	0,6-0,8	156053046	MU.0.0.31	1	32		156151002	VR.0.0.17	1
13		656014008	MU.0.0.37	1	33		156123002	MU.0.0.16	1
14		000097922	BP.2.0.20	1	34		156118018	VP.0.0.29	1
15		056020044	VS.0.0.17	1	35		156122010	MU.0.0.44	1
16	S1	056067192	MU.0.0.38	1	36	S2	056067162	MU.0.0.4	1
17		057014041	MU.0.7	1	37	Motor-Drive	056126066	MU.0.11.1	1
18		056054077	MU.0.0.57	2	38		156118017	VP.0.0.28	1
19		056076198	MU.0.0.39	2	39		057094022	MQ.0.0.11	1
20		756089009	MU.0.0.14	3	40	PL1	056072066	MU.0.0.46	1

# Notes

Lined area for taking notes, consisting of horizontal lines.

# TRUE BLUE<sup>®</sup>

## WARRANTY

Effective January 1, 2006

This limited warranty supersedes all previous Miller warranties and is exclusive with no other guarantees or warranties expressed or implied.

**LIMITED WARRANTY** – Subject to the terms and conditions below, ITW Welding Products Italy S.r.l., warrants to its original retail purchaser that new Miller equipment sold after the effective date of this limited warranty is free of defects in material and workmanship at the time it is shipped by Miller. THIS WARRANTY IS EXPRESSLY IN LIEU OF ALL OTHER WARRANTIES, EXPRESS OR IMPLIED, INCLUDING THE WARRANTIES OF MERCHANTABILITY AND FITNESS.

Within the warranty periods listed below, Miller will repair or replace any warranted parts or components that fail due to such defects in material or workmanship. Miller must be notified in writing within thirty (30) days of such defect or failure, at which time Miller will provide instructions on the warranty claim procedures to be followed.

Miller shall honor warranty claims on warranted equipment listed below in the event of such a failure within the warranty time periods. All warranty time periods start on the date that the equipment was delivered to the original retail purchaser, or one year after the equipment is sent to a European distributor or eighteen months after the equipment is sent to an International distributor.

1. 5 Years Parts – 3 Years Labor
  - \* Original main power rectifiers
  - \* Inverters (input and output rectifiers only)
2. 3 Years — Parts and Labor
  - \* Transformer/Rectifier Power Sources
  - \* Plasma Arc Cutting Power Sources
  - \* Semi-Automatic and Automatic Wire Feeders
  - \* Inverter Power Sources (unless otherwise stated)
  - \* Water Coolant Systems (integrated)
  - \* Intelligit
  - \* Maxstar 150
  - \* Engine Driven Welding Generators  
**(NOTE: Engines are warranted separately by the engine manufacturer.)**
3. 2 year – Parts and Labor (Panther only)
  - \* Hydramate 1&2 Water Cooling Unit
4. 1 year – Parts and Labor unless specified
  - \* DC 253 & 403 Rectifier (April 06>)
  - \* Migmatic 171 (April 06>)
  - \* Motor Driven Guns (w/exception of Spoolguns)
  - \* Process Controllers
  - \* Positioners and Controllers
  - \* Automatic Motion Devices
  - \* RFCS Foot Controls
  - \* IHPS Power Sources and Coolers
  - \* Water Coolant Systems (non-integrated)
  - \* Flowgauge and Flowmeter Regulators (No Labor)
  - \* HF Units
  - \* Grids
  - \* Spot Welders
  - \* Load Banks
  - \* Arc Stud power sources and Arc Stud guns
  - \* Running Gear/Trailers
  - \* Plasma Cutting Torches (except APT & SAF Models)
  - \* Field Options  
**(NOTE: Field options are covered under True Blue<sup>®</sup> for the remaining warranty period of the product they are installed in, or for a minimum of one year — whichever is greater.)**
5. 6 Months — Batteries
6. 90 Days — Parts
  - \* MIG Guns/TIG Torches
  - \* Induction heating coils and blankets

- \* APT Model Plasma Cutting Torches
- \* Remote Controls
- \* Accessory Kits
- \* Replacement Parts (No labor)
- \* Spoolmate Spoolguns
- \* Canvas covers

Miller's True Blue<sup>®</sup> Limited Warranty shall not apply to:

1. **Consumable components; such as contact tips, cutting nozzles, contactors, brushes, slip rings, relays or parts that fail due to normal wear.**
2. Items furnished by Miller, but manufactured by others, such as engines or trade accessories. These items are covered by the manufacturer's warranty, if any.
3. Equipment that has been modified by any party other than Miller, or equipment that has been improperly installed, improperly operated or misused based upon industry standards, or equipment which has not had reasonable and necessary maintenance, or equipment which has been used for operation outside of the specifications for the equipment.

MILLER PRODUCTS ARE INTENDED FOR PURCHASE AND USE BY COMMERCIAL/INDUSTRIAL USERS AND PERSONS TRAINED AND EXPERIENCED IN THE USE AND MAINTENANCE OF WELDING EQUIPMENT.

In the event of a warranty claim covered by this warranty, the exclusive remedies shall be, at Miller's option: (1) repair; or (2) replacement; or, where authorized in writing by Miller in appropriate cases, (3) the reasonable cost of repair or replacement at an authorized Miller service station; or (4) payment of or credit for the purchase price (less reasonable depreciation based upon actual use) upon return of the goods at customer's risk and expense. Miller's option of repair or replacement will be F.O.B., Factory at ITW Welding Products Group Europe, or F.O.B. at a Miller authorized service facility as determined by Miller. Therefore no compensation or reimbursement for transportation costs of any kind will be allowed.

TO THE EXTENT PERMITTED BY LAW, THE REMEDIES PROVIDED HEREIN ARE THE SOLE AND EXCLUSIVE REMEDIES. IN NO EVENT SHALL Miller BE LIABLE FOR DIRECT, INDIRECT, SPECIAL, INCIDENTAL OR CONSEQUENTIAL DAMAGES (INCLUDING LOSS OF PROFIT), WHETHER BASED ON CONTRACT, TORT OR ANY OTHER LEGAL THEORY.

ANY EXPRESS WARRANTY NOT PROVIDED HEREIN AND ANY IMPLIED WARRANTY, GUARANTY OR REPRESENTATION AS TO PERFORMANCE, AND ANY REMEDY FOR BREACH OF CONTRACT TORT OR ANY OTHER LEGAL THEORY WHICH, BUT FOR THIS PROVISION, MIGHT ARISE BY IMPLICATION, OPERATION OF LAW, CUSTOM OF TRADE OR COURSE OF DEALING, INCLUDING ANY IMPLIED WARRANTY OF MERCHANTABILITY OR FITNESS FOR PARTICULAR PURPOSE, WITH RESPECT TO ANY AND ALL EQUIPMENT FURNISHED BY MILLER IS EXCLUDED AND DISCLAIMED BY MILLER.

Some states in the U.S.A. do not allow limitations of how long an implied warranty lasts, or the exclusion of incidental, indirect, special or consequential damages, so the above limitation or exclusion may not apply to you. This warranty provides specific legal rights, and other rights may be available, but may vary from state to state.

In Canada, legislation in some provinces provides for certain additional warranties or remedies other than as stated herein, and to the extent that they may not be waived, the limitations and exclusions set out above may not apply. This Limited Warranty provides specific legal rights, and other rights may be available, but may vary from province to province.



# Owner's Record

Please complete and retain with your personal records.

Model Name

Serial/Style Number

Purchase Date

(Date which equipment was delivered to original customer.)

Distributor

Address

Country

Zip/Postal Code



# For Service

**Contact a *DISTRIBUTOR* or *SERVICE AGENCY* near you.**

Always provide Model Name and Serial/Style Number.

Contact your Distributor for:

Welding Supplies and Consumables

Options and Accessories

Service and Repair

Replacement Parts

Owner's Manuals

Contact the Delivering Carrier to:

File a claim for loss or damage during shipment.

For assistance in filing or settling claims, contact your distributor and/or equipment manufacturer's Transportation Department.

**ITW Welding Products Italy S.r.l.**

Via Privata Iseo, 6/E

20098 San Giuliano

Milanese, Italy

Phone: 39 (0) 2982901

Fax: 39 (0) 298290-203

email: miller@itw-welding.it

