

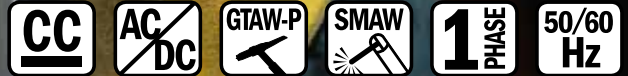

MT200-AC/DC

WELDING MACHINE OWNER'S MANUAL

FORM MT200-0M



Please read and understand this instruction manual carefully before operating this equipment.



CSA E60974-1



www.CKWORLDWIDE.com

THANK YOU FOR YOUR PURCHASE OF THE CK WORLDWIDE MT200-AC/DC TIG WELDING SYSTEM.

At CK Worldwide, we take pride in the trusted quality, innovation, and support we deliver to our customers and the TIG welding community as a whole. The MT200-AC/DC is the next step in our progression as “The Standard in TIG Welding” marking the continuing evolution of CK Worldwide. This TIG Welding System is the latest development in inverter technology. It has been tested and approved by production welders and the best TIG welding professionals in the industry.

Providing solutions through innovation and new product creation have been mainstays of CK Worldwide since its inception. It is the very principle by which we do business. Our goal has always been to provide an outstanding product that not only stands out from its competitors, but also reflects the quality we strive for in every aspect of our business philosophy. From customer service excellence to technical support, we work hard at what we do so that you can too.

We know you will enjoy using this machine. Please let us know if you have any questions or concerns.

The MT200-AC/DC is manufactured and compliant with CAN/CSA E60974-1 & ANS/IEC 60974-1, guaranteeing you electrical safety and performance.



WARRANTY *Please view full Warranty terms and conditions on page 38 of this manual.*

- 3 Years from date of purchase.
- CK Worldwide, Inc. warranties all goods as specified by the manufacturer of those goods.
- This Warranty does not cover freight or goods that have been interfered with.
- All goods in question must be repaired by an authorized repair agent as appointed by this company.
- Warranty does not cover abuse, mis-use, accident, theft, general wear and tear.
- New product will not be supplied unless CK Worldwide, Inc. has inspected product returned for warranty and agrees to replace product.
- Product will only be replaced if repair is not possible.

CALIFORNIA PROPOSITION 65

WARNING: This product contains or produces a chemical known to the State of California to cause cancer and birth defects (or other reproductive harm) (California Health and Safety Code Section 25249.5 et seq.)

WARNING: This product, when used for welding or cutting, produces fumes or gases which contain chemicals known to the State of California to cause birth defects and, in some cases, cancer (California Health and Safety Code Section 25249.5 et seq.).

INFORMATION SOURCES

- California Health and Safety Code, Section 25249.4 through 25249.13.
- The California Office of Environmental Health Hazard Assessment, 301 Capitol Mall, Sacramento, CA 95814; telephone 916-445-6900.
- California Proposition 65 website: www.oehha.ca.gov/prop65.html.
- American National Standards Institute (ANSI). Product Safety Signs And Labels (ANSI Z535.4), available from ANSI, 25 West 43rd Street, New York, NY 10036; telephone: 212-642-4900; web site: www.ansi.org.

CONTENTS

PAGE

Warranty Overview.....	2
Machine Operating Safety.....	4–5
MT200-AC/DC Machine Overview.....	6
MT200-AC/DC System Components.....	7
MT200-AC/DC Specifications.....	8
Machine Layout & Descriptions.....	9
Front Panel Selector Switch Function Descriptions.....	10
Front Panel Control Dial Function Descriptions.....	11
Cautions / Maintenance / Trouble Shooting.....	12
Machine Installation & Operation.....	13
Set Up & Operation for DC TIG Welding.....	14–15
DC TIG Welding.....	16
Pulse TIG Welding, Pulse DC TIG Welding.....	17
Example: Pulse DC TIG Welding.....	18
TIG Welding Fusion and Filler Wire Technique.....	19
Set Up & Operation for AC TIG Welding.....	20–21
Traditional vs. Square Wave Technology AC TIG Welding.....	22–23
Example: Pulse AC TIG Welding.....	24
Remote Controls: Installation and Operation.....	25
Set Up & Operation for SMAW (Stick) Welding.....	26–27
SMAW (Stick) Welding Description / Fundamentals.....	28–29
Tungsten Electrode Selection & Preparation.....	30–32
Troubleshooting Guide — SMAW (Stick) Welding.....	33
Troubleshooting Guide — GTAW (TIG) Welding.....	34–35
TIG Torch Parts.....	36–37
Warranty Terms.....	38
Additional TIG Products.....	39



Use the MT200-AC/DC to weld:

- Aluminum
- Titanium
- Magnesium
- Stainless Steel
- Low Alloy Steel
- Deoxidized Copper
- *And much more!*

CK WORLDWIDE, INC.

Phone: 1.800.426.0877 Fax: 1.800.327.5038
P.O. Box 1636, Auburn, Washington 98071 USA

CONNECT WITH US ON:



www.CKWORLDWIDE.com

SAFETY

Welding and cutting equipment can be dangerous to both the operator and people in or near the surrounding working area, if the equipment is not correctly operated. Equipment must only be used under the strict and comprehensive observance of all relevant safety regulations. Read and understand this instruction manual carefully before the installation and operation of this equipment.



ELECTRIC SHOCK: It can kill



FUMES AND GASES ARE DANGEROUS

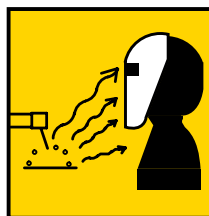

ARC RAYS: harmful to people's eyes and skin

MACHINE OPERATION SAFETY

- Do not switch the function modes while the machine is welding. Switching of the function modes during welding can damage the machine. Damage caused in this manner will not be covered under warranty.
- Disconnect the electrode-holder cable from the machine before switching on the machine, to avoid arcing should the electrode be in contact with the work piece.
- Operators should be trained and or qualified.

ELECTRIC SHOCK: It can kill. Touching live electrical parts can cause fatal shocks or severe burns. The electrode and work circuit is electrically live whenever the output is on. The input power circuit and internal machine circuits are also live when power is on. Incorrectly installed or improperly grounded equipment is dangerous.

- Connect the primary input cable according to American standards and regulations. ANSI Z49.1.
- Avoid all contact with live electrical parts of the welding circuit, electrodes and wires with bare hands. The operator must wear dry welding gloves while he/she performs the welding task.
- The operator should keep the work piece insulated from himself/herself.
- Keep cords dry, free of oil and grease, and protected from hot metal and sparks.
- Frequently inspect input power cable for wear and tear, replace the cable immediately if damaged, bare wiring is dangerous and can kill.
- Do not use damaged, under-sized, or badly joined cables.
- Do not drape cables over your body.

FUMES AND GASES ARE DANGEROUS: Smoke and gas generated while welding or cutting can be harmful to people's health. Welding produces fumes and gases. Breathing these fumes and gases can be hazardous to your health.

- Do not breathe the smoke and gas generated while welding or cutting, keep your head out of the fumes.
- Keep the working area well ventilated, use fume extraction or ventilation to remove welding fumes and gases.
- In confined or heavy fume environments always wear an approved air-supplied respirator. Welding fumes and gases can displace air and lower the oxygen level causing injury or death. Be certain the air in your work environment is safe to breathe.
- Do not weld in locations near degreasing, cleaning, or spraying operations. The heat and rays of the arc can react with vapors to form highly toxic and irritating gases.
- Materials such as galvanized, lead, or cadmium plated steel, contain elements that can give off toxic fumes when welded. Do not weld these materials unless the area is very well ventilated, and or wearing an air supplied respirator.

ARC RAYS: Harmful to people's eyes and skin. Arc rays from the welding process produce intense visible and invisible ultraviolet and infrared rays that can burn eyes and skin.

- Always wear a welding helmet with correct shade of filter lens and suitable protective clothing including welding gloves while the welding operation is performed.
- Measures should be taken to protect people in or near the surrounding working area. Use protective screens or barriers to protect others from flash, glare and sparks; warn others not to watch the arc.

FIRE HAZARD: Welding on closed containers, such as tanks, drums, or pipes, can cause them to explode. Flying sparks from the welding arc, hot work piece, and hot equipment can cause fires and burns. Accidental contact of electrode to metal objects can cause sparks, explosion, overheating, or fire. Check and be sure the area is safe before doing any welding.

- Welding sparks may cause fire, therefore remove any flammable materials away from the working area, at least 40 feet (12m) from the welding arc. Cover flammable materials and containers with approved covers if unable to be moved from the welding area.
- Do not weld on closed containers such as tanks, drums, or pipes, unless they are properly prepared according to the required Safety Standards to insure that flammable or toxic vapors and substances are totally removed, these can cause an explosion even though the vessel has been “cleaned”. Vent hollow castings or containers before heating, cutting or welding. They may explode.
- Do not weld where the atmosphere may contain flammable dust, gas, or liquid vapors (such as gasoline).
- Have a fire extinguisher nearby and know how to use it. Be alert that welding sparks and hot materials from welding can easily go through small cracks and openings to adjacent areas. Be aware that welding on a ceiling, floor, bulkhead, or partition can cause fire on the hidden side.

GAS CYLINDERS: Shielding gas cylinders contain gas under high pressure. If damaged, a cylinder can explode. Because gas cylinders are normally part of the welding process, be sure to treat them carefully. **CYLINDERS** can explode if damaged.

- Protect gas cylinders from excessive heat, mechanical shocks, physical damage, slag, open flames, sparks, and arcs.
- Insure cylinders are held secure and upright to prevent tipping or falling over.
- Never allow the welding electrode or earth clamp to touch the gas cylinder, do not drape welding cables over the cylinder.
- Never weld on a pressurized gas cylinder, it will explode and kill you.
- Open the cylinder valve slowly and turn your face away from the cylinder outlet valve and gas regulator.

GAS BUILD UP: The build up of gas can cause a toxic environment by depleting the air’s oxygen content and potentially resulting in injury or death.

- Shut off shielding gas supply when not in use.
- Always ventilate confined spaces or use approved air-supplied respirator.

ELECTRONIC MAGNETIC FIELDS: **MAGNETIC FIELDS** can affect implanted medical devices.

- Wearers of pacemakers and other implanted medical devices should keep away.
- Implanted medical device wearers should consult their doctor and the device manufacturer before going near any electric welding, cutting or heating operation.

NOISE CAN DAMAGE HEARING: Noise from some processes or equipment can damage hearing. Wear approved ear protection if noise level is high.

HOT PARTS: Items being welded generate and hold high heat and can cause severe burns. Do not touch hot parts with bare hands. Allow a cooling period before working on the welding gun. Use insulated welding gloves and clothing to handle hot parts and prevent burns.



FIRE HAZARD



GAS CYLINDERS Shielding gas cylinders contain gas under high pressure. If damaged, a cylinder can explode



GAS BUILD UP

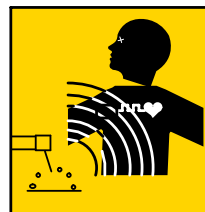

ELECTRONIC MAGNETIC FIELDS can affect implanted medical devices

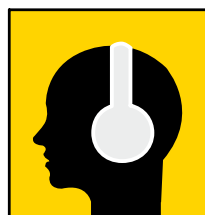

NOISE CAN DAMAGE HEARING



HOT PARTS

MT200-AC/DC WELDING MACHINE



“As a welder of critical aircraft hardware, this machine is extremely easy to use and runs as smooth as our more expensive machines at work.”
– R. Harper, AIRCRAFT WELDER, 38 YEARS EXPERIENCE



OVERVIEW

The MT200-AC/DC is a 220V/115V square wave AC/DC TIG inverter welder incorporating full TIG functionality including AC balance control, gas pre flow and post flow, variable pulse parameters, high frequency (HF) start, and remote current control. The HF start provides easy arc ignition leaving no tungsten inclusion and no contamination of the tungsten electrode. The pulse function with adjustable frequency and background current gives you the added capability to better control heat input into the work, control penetration and control distortion. The AC balance control lets you set the AC TIG arc for cleaning of the oxide layer on aluminum and adjust for a deeper penetrating weld. The foot control provides variable amperage adjustment during welding. Combining the functions of the MT200-AC/DC ensures comprehensive control of the welding parameters when welding both AC and DC, giving you the ability to produce professional TIG welds. The DC SMAW (stick) welding capability delivers a smooth and stable arc allowing easy welding with electrodes obtaining high quality welds with cast iron, stainless, and mild steels. The MT200-AC/DC has set the benchmark for 220V/115V single phase AC/DC welders and is ideal for multiple applications; aluminum and stainless steel fabrication, light industrial use, repair and maintenance. Robust and reliable, built to our specifications and manufactured in compliance to CAN/CSA E60974-1 & ANSI/IEC 60974-1.

SYSTEM COMPONENTS

COMPLETE WELDING SYSTEM INCLUDES:

- MT200-AC/DC
- CK17 Flex-Head Torch with 12.5' (3.8m) Super-Flex™ Cable CK17-12-RSF FX
- Dinse Connector SL2-35MT
- AK-3 Accessories/Consumables Kit AK-3
- Foot Pedal Amperage Control
- Ground Clamp with 12.5' (3.8m) Cable
- Single Flow Regulator
- 6' (1.8m) Gas Hose ARH-6
- 220V to 115V Power Adapter

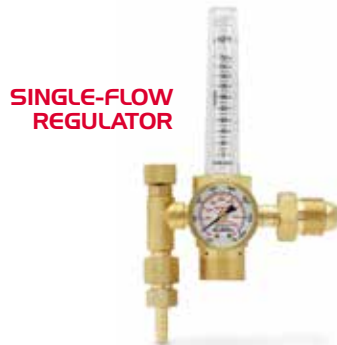

ACCESSORIES / CONSUMABLES AK-3



200AMP AC/DC TIG WELDING MACHINE SQUARE WAVE, PULSE, REMOTE CONTROL

WELDS: Aluminum, Zinc Alloy, Carbon Steels, Alloy Steels, Stainless, Cast Iron, Bronze, Copper

GTAW (TIG)/SMAW (Stick) 200 Amp AC/DC Inverter Welder High Frequency (HF), Pulse, Post Gas, Remote, Square Wave AC

Features

- Latest IGBT Inverter Technology
- AC/DC TIG
- HF TIG Function (provides easy arc start, prevents tungsten damage)
- AC Square Wave with Adjustable AC Balance Control
- Adjustable Pulse Control: 1 – 200Hz
- Adjustable Background Current: 10 – 100%
- Adjustable Post Gas: 0.5 – 20 seconds
- DC SMAW (stick)
- Remote Amperage Control



MT200-AC/DC SPECIFICATIONS

Input Voltage	115VAC ±15%, 50/60Hz
	220VAC ±15%, 50/60Hz, single phase
Input Current (I max)	115V: 21 Amps
	220V: 34 Amps
Output Current Range GTAW	115V: 5 – 140 Amps
	220V: 5 – 200 Amps
Output Current Range SMAW	115V: 10 – 110 Amps
	220V: 10 – 160 Amps
Rated Output GTAW	115V: 140A @ 15.6V, 40% duty cycle
	220V: 200A @ 18.0V, 25% duty cycle
Rated Output SMAW	115V: 110A @ 24.4V, 25% duty cycle
	220V: 160A @ 26.4V, 30% duty cycle

Max. Open Circuit Volts	74 volts
Gas Pre-flow	0.5 seconds
Gas Post-flow	0.5 – 20 seconds
AC Frequency	20 – 250 Hz
Pulse Frequency	1 – 200 Hz
Pulse Width	50%
Background Current	10 – 100%
Arc Start	High Frequency
Dimensions	Height: 15 in. (381 mm)
	Width: 8.5 in. (217 mm)
	Length: 20 in. (502 mm)
Weight	32 lb. (14.5 kg)

MT200-AC/DC

FRONT VIEW



The blue zones on the control dial indicators are standard starting positions for most TIG welding operations.

BACK VIEW



ON/OFF SWITCH
(Located on the back of the machine)

SELECTOR SWITCH FUNCTION DESCRIPTIONS



1 ON/OFF: This switch powers the machine up when switched to the on position and powers the machine down when switched to the off position. *NOTE: The On/Off switch is on the back of the MT200-AC/DC.*



2 AC/DC: Provides selection of AC or DC current in TIG mode. Selecting the AC position provides for AC welding current output. Selecting the DC position provides for DC welding current output.



3 PANEL/REMOTE: Provides selection of remote or panel output current control in TIG mode. Selecting the PANEL position allows current control from the front panel Amps control. Selecting the REMOTE position allows use of a remote current control.



PULSE SELECTOR: Provides selection of Pulse welding mode in TIG mode.

Selecting the PULSE ON position places the machine in Pulse welding mode. Selecting the PULSE OFF position places the machine in standard (non-pulse) welding mode.



5 TIG/STICK: Provides selection of TIG or SMAW (Stick) welding modes. Selecting the TIG position provides for TIG welding function. Selecting the STICK position provides for DC SMAW (Stick) welding function.

CONTROL DIAL FUNCTION DESCRIPTIONS



The blue zones on the control dial indicators are standard starting positions for most TIG welding operations.



A AMPS: Provides adjustment and control of the main welding current. Adjustment range 5–200 Amps (220V), 5–140 Amps (115V)



B AC FREQUENCY: Adjusts the AC output frequency to control the arc cone width and improve directional control of the arc. Adjustment range 20 – 250 Hz.



C AC BALANCE: To understand how balance control works, you first need to understand why aluminum and magnesium require an AC welding output. These materials have an insulating surface oxide layer that melts at a higher temperature than the base metal making it difficult to weld the base metal if the oxides are not removed. AC welding current is ideal because the nature of the AC output assists in breaking the surface oxide layer. The AC Balance dial is for adjusting the current flow time between positive (+) and negative (-). When set at the Max Cleaning position, the time that the tungsten is positive (+) is 50% which promotes an aggressive cleaning action of the oxide film from the material surface. When set at the Max Penetration position, the time that the tungsten is negative (+) is 85% which tightens the arc and provides deeper penetration.



D POST GAS FLOW: Provides adjustment and control of gas flow after the welding arc is extinguished. Post gas flow prevents contamination of the weld pool during its cool down period from molten state to solid at the weld finish and keeps the tungsten electrode protected from oxidizing atmosphere during the cool down cycle. The Post Gas flow time will depend on the tungsten size and welding current that is being used, when the Post Gas flow is set correctly the tungsten electrode will have a clean shiny finish. Adjustment 0.5 – 20 seconds.



E PULSE FREQUENCY: Provides adjustment and setting of the pulse frequency when the machine is set in Pulse mode. It adjusts the amount of times per second (Hz) the output current switches from the peak current setting to background current setting. Adjustment is 1 – 200Hz.

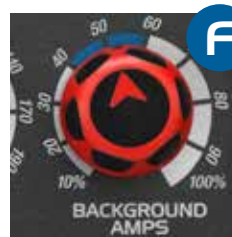

F BACKGROUND AMPS: Provides adjustment and control of the background welding current during pulse welding. Settings represent a percentage of the peak welding current. For example, peak current set at 100 amps with background current set at 20% (20 amps) it means the output current during the pulse cycle will go from 100 amps down to 20 amps during each pulse cycle. Adjustment range: 10 – 100%.

Good ventilation is of critical importance for the normal performance and service life of this equipment

Exposure to extremely dusty, damp, or corrosive air is damaging to the welding machine

For your safety and to avoid electrical shock, please observe all safety notes and precautions detailed in this manual

I. WORKING ENVIRONMENT

- 1.1 The environment in which this welding equipment is installed must be free of grinding dust, corrosive chemicals, flammable gas or materials etc, and at no more than maximum of 80% humidity.
- 1.2 When using the machine outdoors protect the machine from direct sun light, rain water and snow etc; the temperature of working environment should be maintained within -14°F to $+104^{\circ}\text{F}$ (-25.5°C to 40°C).
- 1.3 Keep this equipment 1 foot (0.3m) away from the wall.
- 1.4 Ensure the working environment is well ventilated.

2. SAFETY TIPS

2.1 Ventilation: This equipment is small in size, compact in structure and is efficient in producing welding output. The fan is used to dissipate heat generated by this equipment during the welding operation.

IMPORTANT: Maintain good ventilation of the louvers of this equipment. The minimum distance between this equipment and any other objects in, or near, the working area should be 1 foot (0.3m). Good ventilation is of critical importance for the normal performance and service life of this equipment.

2.2 Thermal Overload Protection: Should the machine be used to an excessive level, or in high temperature environment, poorly ventilated area or if the fan malfunctions, the Thermal Overload Switch will be activated and the machine will cease to operate. Under this circumstance, leave the machine switched on to keep the built-in fan working to bring down the temperature inside the equipment. The machine will be ready for use again when the internal temperature reaches safe level.

2.3 Over-Voltage Supply: Regarding the power supply voltage range of the machine, please refer to Specifications. The MT200-AC/DC features automatic voltage compensation within the given range. If the input power exceeds the stipulated value, it is possible to cause damage to the components of this equipment. Please ensure your primary power supply is correct.

2.4 Do not come into contact with the output terminals while the machine is in operation. An electric shock may possibly occur.

MAINTENANCE

Exposure to extremely dusty, damp, or corrosive air is damaging to the welding machine. In order to prevent any possible failure or fault of this welding equipment, blow the dust out at regular intervals with clean and dry compressed air of required pressure.

PLEASE NOTE: Lack of maintenance can result in the cancellation of the warranty; the warranty of this welding equipment will be void if the machine has been modified, or if an attempt is made to take apart the machine or open the factory seal of the machine without the consent of an authorized representative of the manufacturer.

TROUBLESHOOTING

CAUTION: Only qualified technicians are authorized to undertake the repair of this welding equipment. For your safety and to avoid electrical shock, please observe all safety notes and precautions detailed in this manual.

NOTE: Minimum Motor Generator Power Suggested: 10KVA

Please install the machine strictly according to the following steps. The protection class of this machine is IP21S, so avoid using it in rain.

Avoid using this machine in the rain

CONNECTION OF INPUT CABLES

Primary input cable is supplied with this welding equipment. Connect the primary input cable with power supply of required input voltage. Refer to data plate on machine for Input voltage, IMAX.

ATTENTION! CHECK FOR GAS LEAKS

RECOMMENDED PROCEDURE IS AS FOLLOWS:

1. Connect the regulator to the gas cylinder, and the gas hose assembly to the regulator and machine. Securely tighten all connections.
2. Slowly open the cylinder valve.
3. Set the flow rate on the regulator to approximately 15–25CFH (7–12LMN).
4. Close the cylinder valve and pay attention to the needle indicator of the contents pressure gauge on the regulator, if the needle drops away towards zero there is a gas leak. Sometimes a gas leak can be slow and to identify it will require leaving the gas pressure in the regulator and line for an extended time period. In this situation it is recommended to open the cylinder valve, set the flow rate to 15–25CFH (7–12LMN), close the cylinder valve and check after a minimum of 15 minutes.
5. If there is a gas loss then check all connectors for leakage by brushing or spraying with soapy water. Bubbles will appear at the leakage point.
6. Tighten fitting connections to eliminate gas leakage.

At initial set up and at regular intervals we recommend checking for gas leakage

IMPORTANT! We strongly recommend that you check for gas leakage prior to operation of your machine. We recommend that you close the cylinder valve when the machine is not in use.

CK Worldwide, Inc. authorized representatives or agents of CK Worldwide, Inc. will not be liable or responsible for the loss of any gas.

INSTALLATION SET-UP FOR DC TIG WELDING

INSTALLATION SET UP FOR DC TIG WELDING

- 1 Turn on the machine using the ON/OFF switch (*located on the back of the machine*).
- 2 Select the TIG function with the TIG/STICK selector switch.
- 3 Select DC using the AC/DC selector switch.
- 4 Connect the TIG torch connector to the negative terminal and tighten it.
- 5 Connect the ground cable connector into the positive terminal and tighten it.
- 6 Connect the foot pedal remote lead into the remote socket.
- 7 Connect the torch gas connector into the gas receptacle.
- 8 Connect the gas regulator to the cylinder and connect gas line to the regulator.
- 9 Carefully open the valve of the gas cylinder, set the flow to 15-25CFH (7-12LMN).
Valve located underneath the safety cover.



OPERATION FOR DC TIG WELDING

HF (high frequency) ignition allows the arc to be started in TIG welding without touching the tungsten to the work piece. By depressing the foot pedal the machine will activate the gas flow and the HF ignition resulting in the arc igniting across the gap between the tungsten electrode and the work piece. The distance between the electrode and the work piece can be up to 1/4" (6.3mm). This arc ignition method prevents tungsten inclusion in the work piece, promotes longer tungsten life and offers better operator control over starting and stopping the arc.

- A** Assemble the front end torch parts using the correct size and type of tungsten electrode needed for the job. The tungsten requires a sharpened point for DC welding.
- B** Set the maximum welding current (amps) to be used with the Amps control knob, observing the value set on the digital display.
- C** Hold the torch above the work piece with a 1/8" (3.2mm) gap between the tungsten and work piece.
- D** Depress the foot pedal partially to ignite the arc across the gap between tungsten and the work piece. Maintain the 1/8" (3.2mm) gap between the tungsten and the work piece to maintain the arc.
- E** The foot pedal may be depressed more to increase the welding current up to the panel pre-set value on the display, or depressed less to decrease the welding current.
- F** To discontinue welding, slowly decrease depressing the foot pedal.
- G** Continue holding the torch over the end of the weld until the gas stops flowing.

Having trouble? Please see GTAW (TIG) troubleshooting information on pages 34 & 35



D Hold the torch above the work piece with a 1/8" (3.2mm) gap between the tungsten and work piece.



E Depress the foot pedal partially and the arc will ignite across the gap between the tungsten and work piece. Hold even 1/8" (3.2mm) gap between the work piece and the tungsten to maintain the arc.

DC TIG WELDING

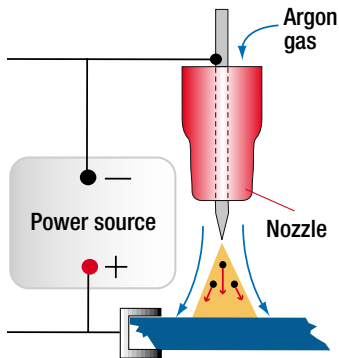
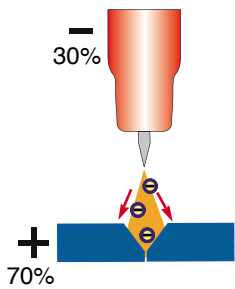

The DC power source produces what is known as DC (direct current) in which the main electrical component known as electrons flow in only one direction from the negative pole (terminal) to the positive pole (terminal). In the DC electrical circuit there is an electrical principle at work which should always be taken into account when using any DC circuit. With a DC circuit 70% of the energy (heat) is always on the positive side. This needs to be understood because it determines what terminal the TIG torch will be connected to (this rule applies to all the other forms of DC welding as well).

DC TIG welding is a process in which an arc is struck between a tungsten electrode and the metal work piece. The weld area is shielded by an inert gas flow to prevent contamination of the tungsten, molten pool and weld area. When the TIG arc is struck the inert gas is ionized and superheated changing its molecular structure which converts it into a plasma stream. This plasma stream flowing between the tungsten and the work piece is the TIG arc and can be as hot as 34,000°F (18,871°C). It is a very pure and concentrated arc which provides the controlled melting of most metals into a weld pool. TIG welding offers the user the greatest amount of flexibility to weld the widest range of material and thickness and types. DC TIG welding is also the cleanest weld with no sparks or spatter.

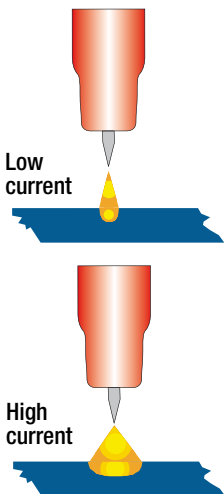

The intensity of the arc is proportional to the current that flows from the tungsten. The welder regulates the welding current to adjust the power of the arc. Thin material requires a less powerful arc with less heat to melt the material so less current (amps) is required. Thicker material requires a more powerful arc with more heat so more current (amps) are necessary to melt the material.

HF ARC IGNITION FOR TIG WELDING

HF (high frequency) ignition allows the arc to be started in TIG (tungsten inert gas) welding without touching the tungsten to the work piece. By depressing the foot pedal the machine will activate the gas flow and introduce the HF (high frequency) (high voltage) spark, this "ionizes" the air gap making it conductive allowing an arc to be created without touching the tungsten to the work piece. The gas molecules are superheated by the arc creating a stream of superheated gas that changes the molecular structure producing a plasma stream. This plasma stream provides heat and energy that allows us to melt and fuse metals in an inert gas shielded environment known as TIG (tungsten inert gas) welding.

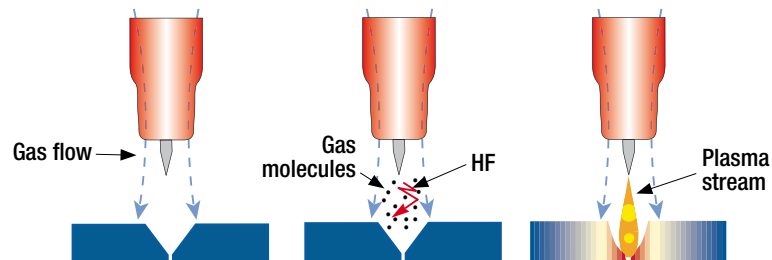

Pulse TIG welding is when the output current changes between high and low current. Electronics within the welding machine create the pulse cycle. Welding is done during the high-current interval (referred to as peak current). During the low-current interval (referred to as background current) the weld pool cools due to an overall lower heat input into the base metal. Pulsed output allows for controlled heating and cooling periods during welding, providing better operator control of heat input, weld penetration and weld appearance.

The MT200-AC/DC has three variables within the pulse cycle:
Peak Current - Background Current - Pulse Frequency

Setting and manipulation of these variables will determine the nature of the weld current output and is at the discretion of the operator.

PEAK CURRENT is the main welding current set to melt the material being welded and works the same as setting maximum current values for regular TIG welding.

BACKGROUND CURRENT is the level set to cool the weld puddle and lower the overall heat input. Background current is a percentage of peak current. As a rule, use enough background current to reduce the weld pool to about half its normal size while still keeping the weld pool fluid. As a guide start by setting the background current at 40 to 60 percent of peak current.

PULSE FREQUENCY is the control of the amount of times per second (Hz) that the welding current switches from peak current to background current. DC Pulse TIG frequency ranges from 1 to 200 Hz depending on the job application. Control of the pulse frequency also determines the appearance of the weld.

The MT200-AC/DC has three variables within the pulse cycle:
Peak Current
Background Current
Pulse Frequency

DC PULSE TIG WELDING

DC Pulse TIG welding allows faster welding speeds with better control of the heat input to the work, which is an advantage in the welding of thin stainless and carbon steels. It reduces the heat input, minimizing distortion and warping of the work. The high pulse frequency capability of the advanced inverter agitates the weld puddle and allows you to move quickly without transferring too much heat to the surrounding metal. Pulsing also constricts and focuses the arc cone which increases arc stability and penetration.

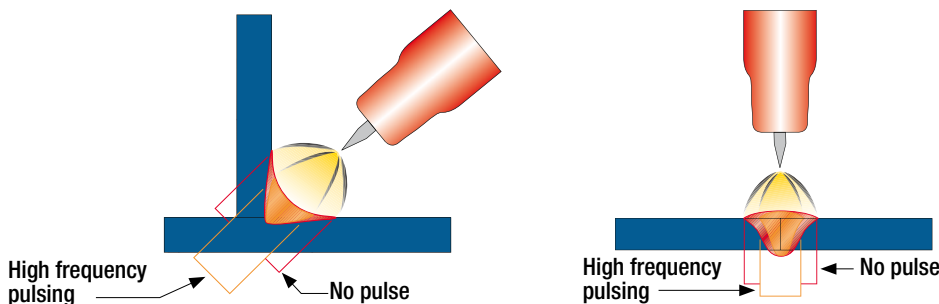
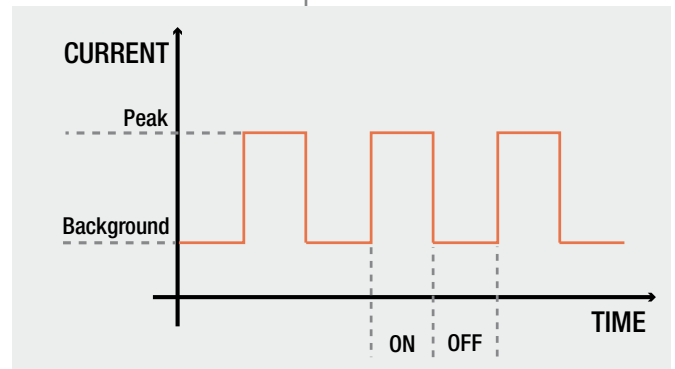

EXAMPLE OF PULSE DC TIG WELDING

PULSE DC TIG WELDING — SET UP PARAMETERS:

The following steps are a guide for you to set the machine up in Pulse mode. You can experiment by changing any of the variables to see what effect it has over the weld. It is suggested that you change only one variable at a time and then check the results. In this way you acquire a better understanding of how each variable affects the outcome of the weld.

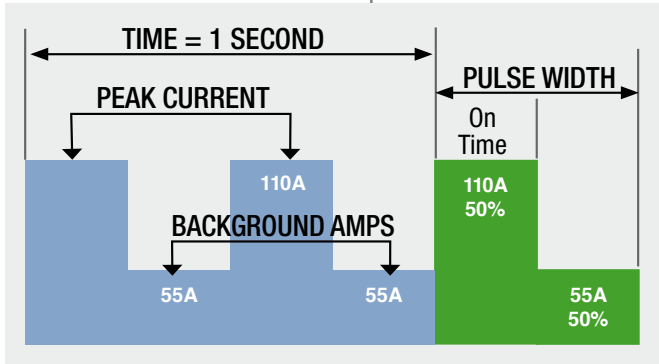

Example of Pulse vs Non-Pulse weld finish

- 1 Prepare the machine for DC TIG welding
- 2 Set the Pulse switch to PULSE ON
- 3 Set the Peak Current at 110 Amps
- 4 Set the Background Amps around 50% (Background Amps is a percent of the Peak Current, e.g. 50% of 110 = 55 Amps)
- 5 Set the Pulse Frequency around 2 Hz (pulses per second)

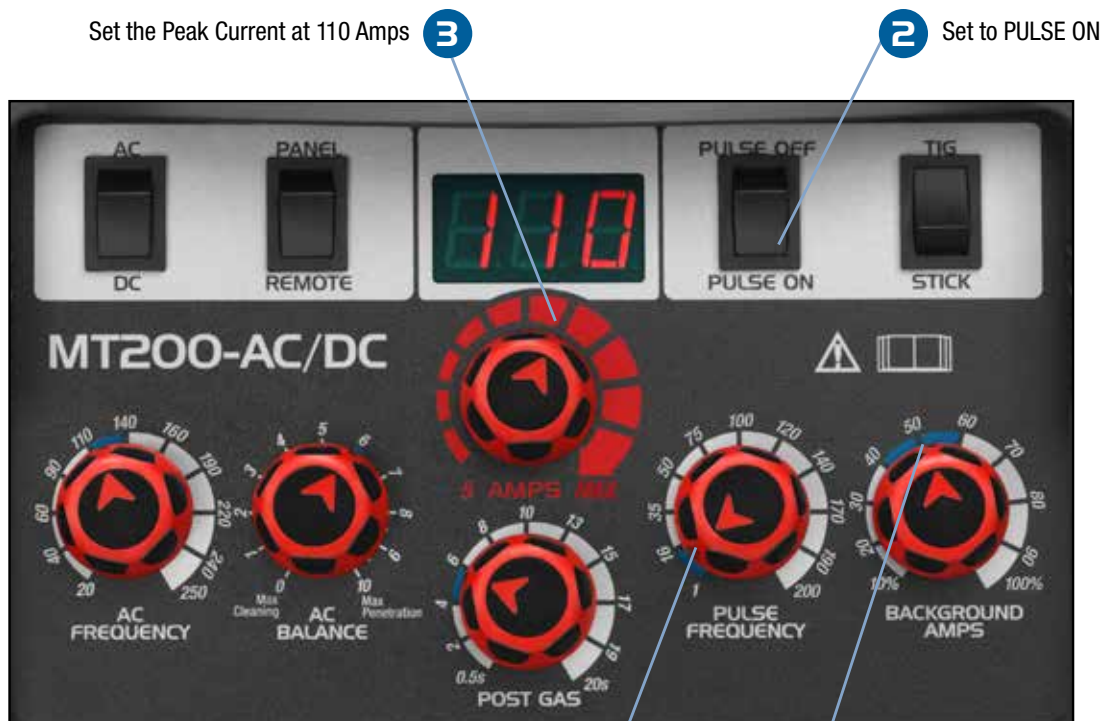

Set the Peak Current at 110 Amps

Set to PULSE ON

Set the Pulse Frequency around 2 Hz (pulses per second)

Set the Background Amps around 50%

TIG WELDING FUSION/FILLER WIRE TECHNIQUES

TIG WELDING FUSION TECHNIQUE

Manual TIG welding is often considered the most difficult of all the welding processes. Because the welder must maintain a short arc length, great care and skill are required to prevent contact between the electrode and the work piece. Similar to Oxygen Acetylene torch welding, TIG welding normally requires two hands. The welder manually feeds a filler wire into the weld pool with one hand while manipulating the welding torch in the other. However, some welds combining thin materials can be accomplished without filler metal, like edge, corner, and butt joints. This is known as Fusion welding, where the edges of the metal pieces are melted together using only the heat and arc force generated by the TIG arc. Once the arc is started the torch tungsten is held in place until a weld pool is created, a circular movement of the tungsten will assist in creating a weld pool of the desired size. Once the weld pool is established, tilt the torch at about a 75° angle and move smoothly and evenly along the joint while fusing the materials together.

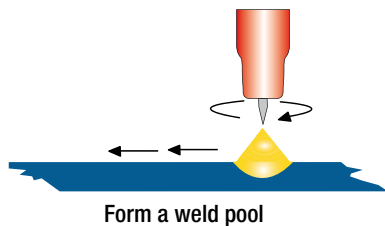

Form a weld pool

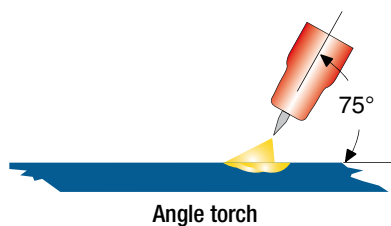

Angle torch

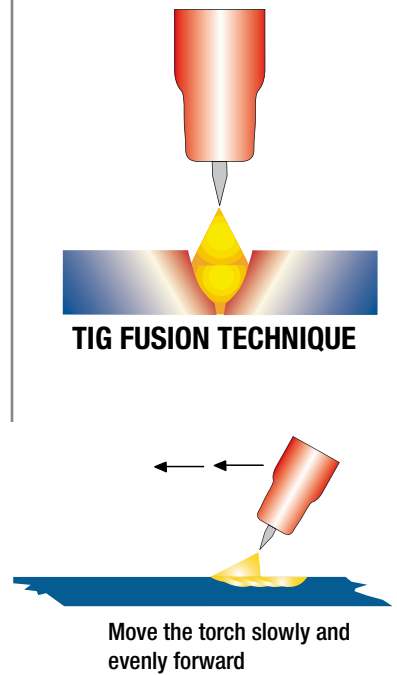

TIG FUSION TECHNIQUE

Move the torch slowly and evenly forward

TIG WELDING WITH FILLER WIRE TECHNIQUE

It is necessary in many situations with TIG welding to add a filler wire into the weld pool to build up weld reinforcement and create a strong weld. Once the arc is started, the tungsten is held in place until a weld pool is created, a circular movement of the tungsten will assist in creating a weld pool of the desired size. Once the weld pool is established tilt the torch at about a 75° angle and move smoothly and evenly along the joint. The filler metal is introduced to the leading edge of the molten pool. The filler wire is usually held at about a 15° angle and fed into the leading edge of the molten pool. The arc will melt the filler wire into the weld pool as the torch is moved forward. A dabbing technique can be used to control the amount of filler wire added, the wire is fed into the molten pool and retracted in a repeating sequence as the torch is moved slowly and evenly forward. It is important during the weld process to keep the molten end of the filler wire inside the gas shield as this protects the end of the filler wire from being oxidized and contaminating the weld pool.

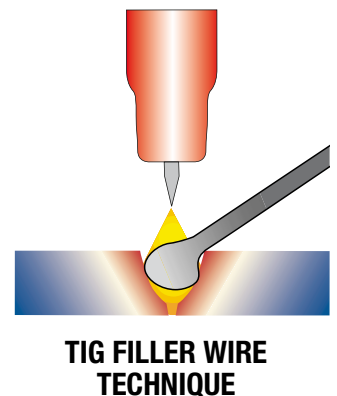

TIG FILLER WIRE TECHNIQUE

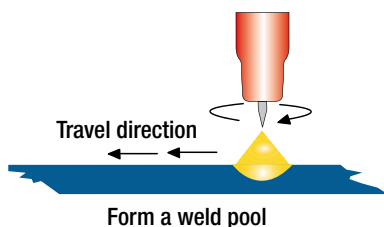

Form a weld pool

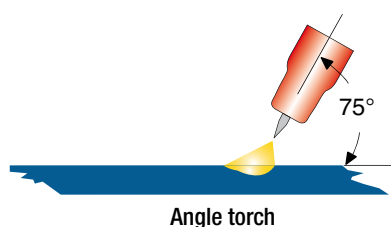

Angle torch

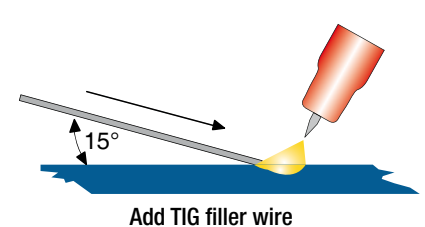

Add TIG filler wire

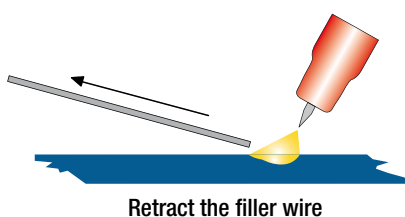

Retract the filler wire

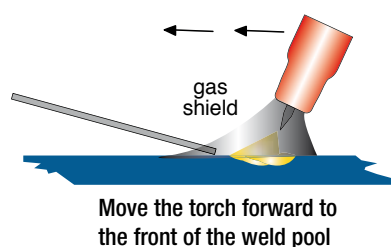

Move the torch forward to the front of the weld pool

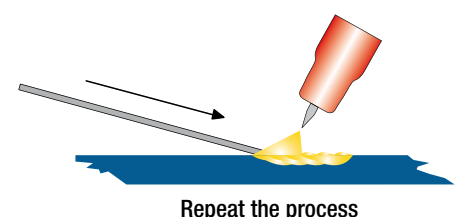

Repeat the process

INSTALLATION SET-UP FOR AC TIG WELDING

INSTALLATION SET UP FOR AC TIG WELDING

- 1 Turn on the machine using the ON/OFF switch (located on the back of the machine).
- 2 Select the TIG function with the TIG/STICK selector switch.
- 3 Select AC using the AC/DC selector switch.
- 4 Connect the TIG torch connector to the negative terminal and tighten it.
- 5 Connect the ground cable connector into the positive terminal and tighten it.
- 6 Connect the foot pedal remote lead into the remote socket.
- 7 Connect the torch gas connector into the gas receptacle.
- 8 Connect the regulator to the cylinder, connect the gas lead to the regulator.
- 9 Carefully open the valve of the gas cylinder, set the flow to 15-25CFH (7-12LMN). Valve located underneath the safety cover.



OPERATION FOR AC TIG WELDING

AC (alternating current) enables you to TIG weld non-ferrous alloys like aluminum, aluminum alloys and magnesium. These materials have an insulating surface oxide layer that melts at a higher temperature than the base metal making it difficult to weld the base metal if the oxides are not removed. AC welding current is ideal because the nature of the AC wave form assists in breaking the surface oxide layer. HF arc ignition provides easy and precise starting of the arc.

- A** Assemble the front end torch parts using the correct size and type of tungsten electrode for the job. The tungsten electrode requires a sharpened point for AC welding with the MT200-AC/DC.
- B** Set the maximum welding current (amps) to be used with the Amps control knob, observing the value set on the digital display.
- C** Set the AC Balance control knob to setting 6.
- D** Hold the torch above the work piece with a 1/8" (3.2mm) gap between the tungsten and work piece.
- E** Depress the foot pedal partially to ignite the arc across the gap between tungsten and the work piece. Maintain the 1/8" (3.2mm) gap between the tungsten and the work piece to maintain the arc.
- F** The foot pedal may be depressed more to increase the welding current up to the panel pre-set value on the display, or depressed less to decrease the welding current.
- G** To discontinue welding, slowly decrease depressing the foot pedal.
- H** Continue holding the torch over the end of the weld until the gas stops flowing.

Having trouble? Please see GTAW (TIG) troubleshooting information on pages 34 & 35



D Hold the torch above the work piece with a 1/8" (3.2mm) gap between the tungsten and work piece.



E Depress the foot pedal partially and the arc will ignite across the gap between the tungsten and work piece. Hold even 1/8" (3.2mm) gap between the work piece and the tungsten to maintain the arc.

AC TIG WELDING

AC (alternating current) enables you to TIG weld non-ferrous alloys like aluminum, magnesium and aluminum alloys.

TRADITIONAL AC TIG WELDING EQUIPMENT

AC (alternating current) enables you to TIG weld non-ferrous alloys like aluminum, magnesium and aluminum alloys. These materials have an insulating surface oxide layer that melts at a higher temperature than the base metal making it difficult to weld the base metal if the oxides are not removed. AC welding current is ideal because the nature of the AC wave form assists in breaking the surface oxide layer. AC current flows from – (straight) polarity to + (reverse) polarity. The reverse polarity breaks the surface oxides while the straight polarity melts the base metal.

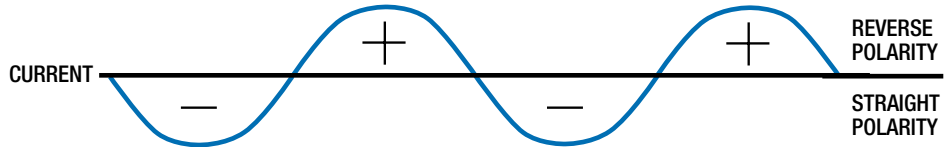

There are inherent problems that come with AC TIG such as arc rectification, arc stutter, arc wandering and arc stoppage. These problems typically occur during the transition between + and – cycles. The current is 30% less during the half of the cycle when the electrode is positive and there is a resistance of the electron flow during this half cycle (rectification). The lack of current flow during this half cycle makes the AC arc unstable.

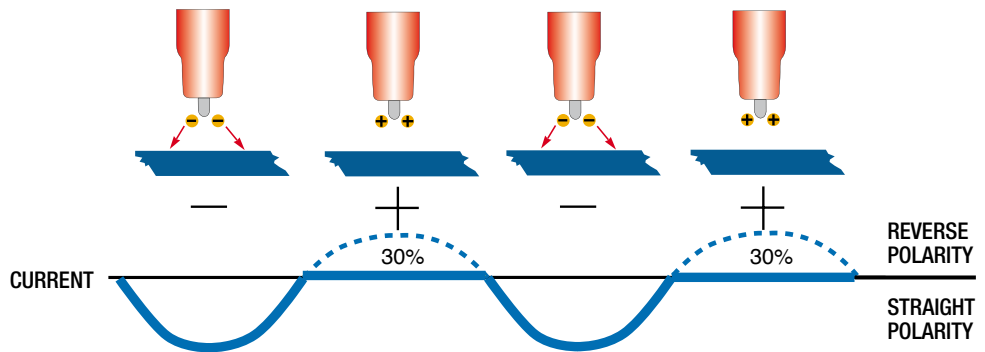

To overcome this lack of flow during one half of the cycle, a high-frequency (HF) voltage is generated and fed into the welding circuit. The HF maintains the arc stability during the half cycle when the electrode is positive.

HIGH-FREQUENCY VOLTAGE IN THE WELDING CIRCUIT

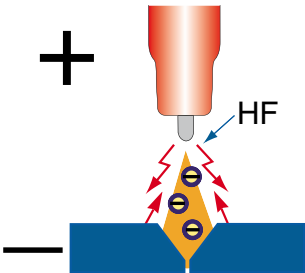

UNBALANCED WAVE FORM

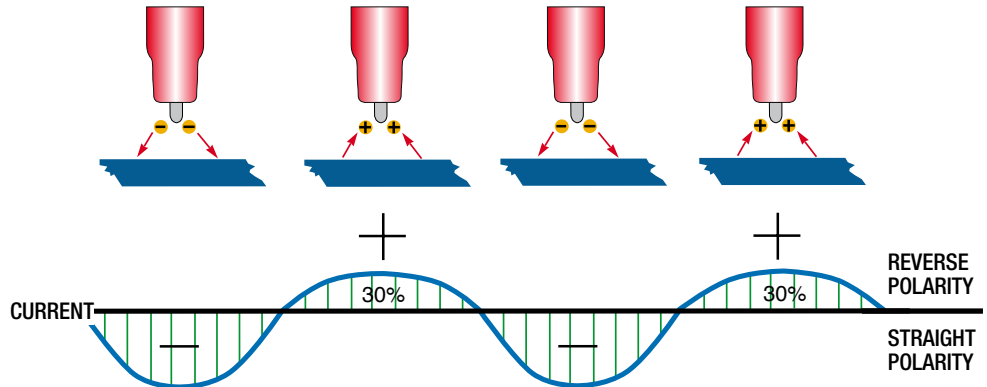

High-frequency voltage flows continually in the welding circuit and keeps the shielding gas in the welding area in an ionized state. The ionized gas maintains the arc during the half cycle when the electrode is positive. However while the arc is maintained less current flows during this half of the AC cycle, producing an unbalanced wave.

In older machines, a balanced current output wave was achieved using a large number of capacitors in series in the welding circuit. Modern TIG power sources use electronics to create and maintain a balanced wave and now most AC TIG power sources produce a square wave current output.

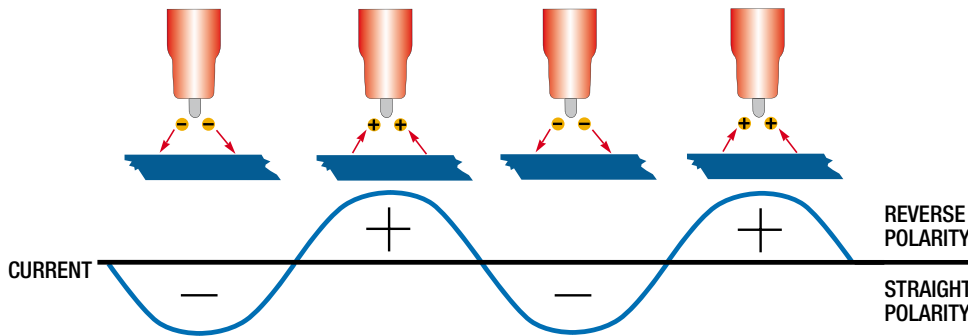

MT200-AC/DC SQUARE WAVE TECHNOLOGY

A square wave power supply can change the current from electrode + positive to electrode - negative very quickly. This produces high voltage as the current switches polarities allowing the arc to restart easily. The arc can be maintained without the use of high-frequency or any other arc stabilizing methods.

BALANCED SQUARE WAVE FORM

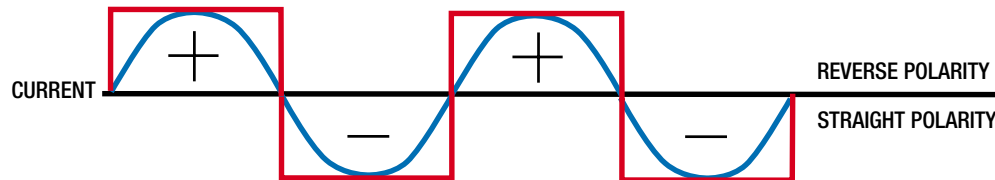

The output current and voltage are controlled electronically so the amount of current electrode positive and the amount of current electrode negative can be adjusted. This allows the welder to adjust the amount of cleaning and the amount of penetration. This is achieved electronically by adjusting the AC balance control dial on the welding machine. More current flow from the + straight polarity produces stronger current flow to the tungsten and is good for removing the oxidized surface of the work piece. However too much + current flow can drive too much energy to the tungsten causing it to overheat and melt the tungsten electrode.

BALANCE ADJUSTED FOR MORE PENETRATION / COOLER TUNGSTEN

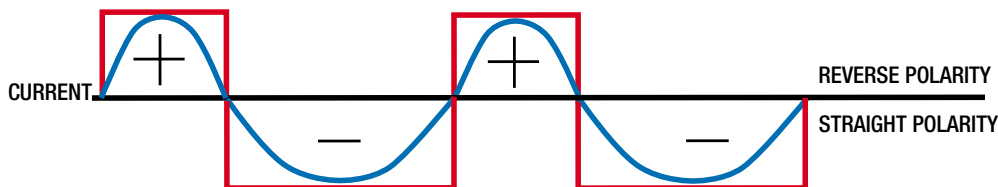

BALANCE ADJUSTED FOR MORE OXIDE CLEANSING ACTION / HOTTER TUNGSTEN

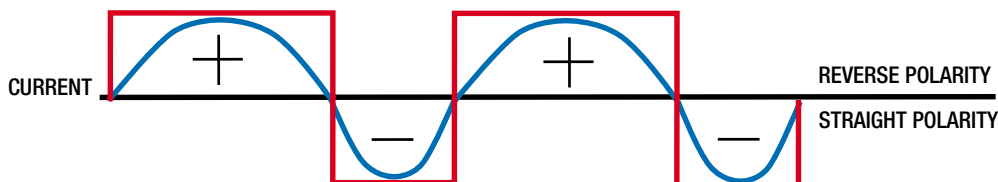

EVEN BALANCE

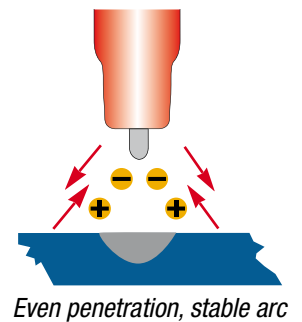

LESS POSITIVE BALANCE

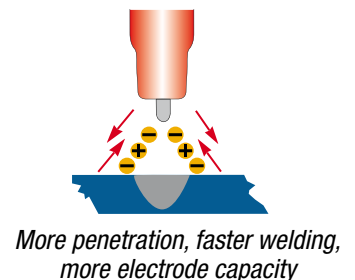

MORE POSITIVE BALANCE

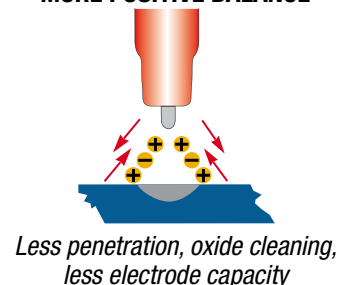

EXAMPLE OF PULSE AC TIG WELDING

PULSE AC TIG WELDING — SET UP PARAMETERS:

Material = aluminum x 1/8" / Tungsten Electrode = 3/32" Zirconiated / Gas = Argon

The following steps are a guide for you to set the machine up in AC Pulse mode. You can experiment by changing any of the variables to see what effect it has over the weld. It is suggested that you change only one variable at a time and then check the results. In this way you acquire a better understanding of how each variable affects the outcome of the weld.

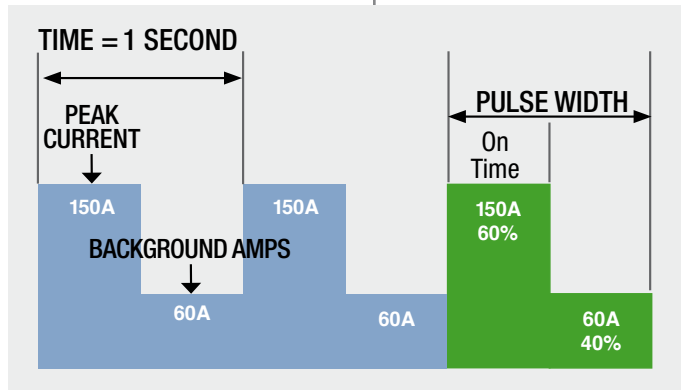

Example of pulsed weld finish

- 1 Prepare the machine for AC TIG welding as per the AC TIG operating guide.
- 2 Set the Peak Current at 150 Amps.
- 3 Set the Background Amps around 40% (Background Amps is % of the Peak Current e.g., 40% of 150 = 60 Amps).
- 4 Set the Pulse Frequency around 1Hz (pulses per second).

Set the Peak Current at 150 Amps.



Set the Pulse Frequency around 1 Hz (pulses per second).

Set the Background Amps around 40%.

REMOTE AMPERAGE CONTROL INSTALLATION & OPERATIONS

Remote amperage controls allow for the welding current to be adjusted remotely from the welding machine during welding. Generally there are several types of remote amperage control available:

- **HAND AMPERAGE CONTROL** located on the torch handle allowing the operator to adjust the welding current by rolling the potentiometer wheel, moving potentiometer slider, or rotating potentiometer belt to increase or decrease the amount of amperage desired.



- **FOOT AMPERAGE CONTROL** allows the operator to adjust the welding current by depressing the pedal to increase the amperage desired and releasing the pedal to decrease.

CK WORLDWIDE REMOTE AMPERAGE CONTROL OPTIONS



SGACV
Steady-Grip™
SLIDING POTENTIOMETER
(torch not included)

CONNECTION AND OPERATION OF THE REMOTE FOOT CONTROL

Place the remote selector switch on the front panel of machine in the REMOTE position. This gives the current control to the remote control.



Connect the remote control 5 pin plug from the foot control pedal to the 5 pin remote receptacle on the front panel of the machine.

Depress the foot pedal to activate the machine, further depressing the pedal will increase the current level to the maximum set by the amps control knob.



RACCV (VELCRO)
Rotary Amperage Control
ROTATING BELT POTENTIOMETER



AMTCV (VELCRO)
Amtrak™ Amperage Control
SLIDING POTENTIOMETER



WACCV (VELCRO)
Wheel Amperage Control
WHEELED POTENTIOMETER

CONNECTION AND OPERATION OF THE REMOTE HAND CONTROL

Place the remote selector switch on the front panel of machine in the REMOTE position. This gives the current control to the remote control.



Connect the remote control 5 pin plug from the hand control to the 5 pin remote receptacle on the front panel of the machine.

Move the hand remote potentiometer mechanism to activate the machine and select the desired welding current up to the maximum level set by the amps control knob.



INSTALLATION SET-UP FOR SMAW (STICK) WELDING

INSTALLATION SET UP FOR SMAW (STICK) WELDING

- 1 Turn the power source on and select the STICK function with the TIG/STICK selector switch.
- 2 **Connection of Output Cables**
Two weld output receptacles are available on this welding machine. For Stick welding the electrode holder is connected to the positive receptacle, while the ground lead (work piece) is connected to the negative receptacle, this is known as DC+ polarity. However various electrodes require a different polarity for optimum results and careful attention should be paid to the polarity, refer to the electrode manufacturer's information for the correct polarity.
DC+ Electrode connected to (+) output receptacle.
DC- Electrode connected to (-) output receptacle.



OPERATION FOR SMAW (STICK) WELDING

- 3 Set the welding current relevant to the electrode type and size being used as recommended by the electrode manufacturer.
- 4 Place the electrode into the electrode holder and clamp tight.
- 5 Scratch the electrode against the work piece to create an arc and hold the electrode steady to maintain the arc.
- 6 Hold the electrode slightly above the work piece to maintain the arc while traveling at an even speed to create an even weld deposition.
- 7 To finish the weld, break the arc by quickly snapping the electrode away from the work piece.
- 8 Wait for the weld to cool and carefully chip away the slag to reveal the weld metal underneath.

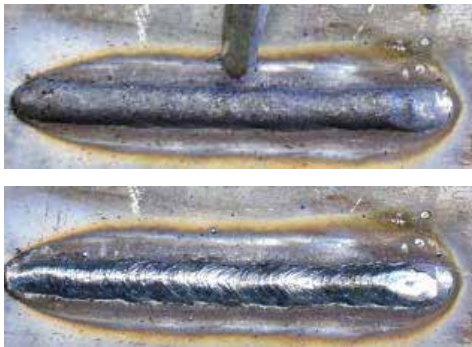

Having trouble? Please see SMAW (Stick) troubleshooting information on pages 33



SMAW (STICK) WELDING GENERAL DESCRIPTION

One of the most common types of arc welding is shielded metal arc welding (SMAW) or stick welding. An electric current is used to strike an arc between the base material and a consumable electrode rod or 'stick'. The electrode rod is made of a material that is compatible with the base material being welded and is covered with a flux that gives off gaseous vapors that serve as a shielding gas and provide a layer of slag, both of which protect the weld area from atmospheric contamination. The electrode core itself acts as filler material. The residue from the flux that forms a slag covering over the weld metal must be chipped away after welding.

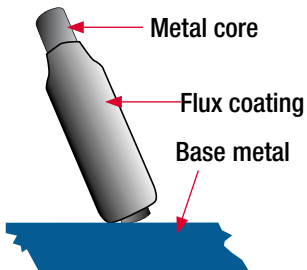
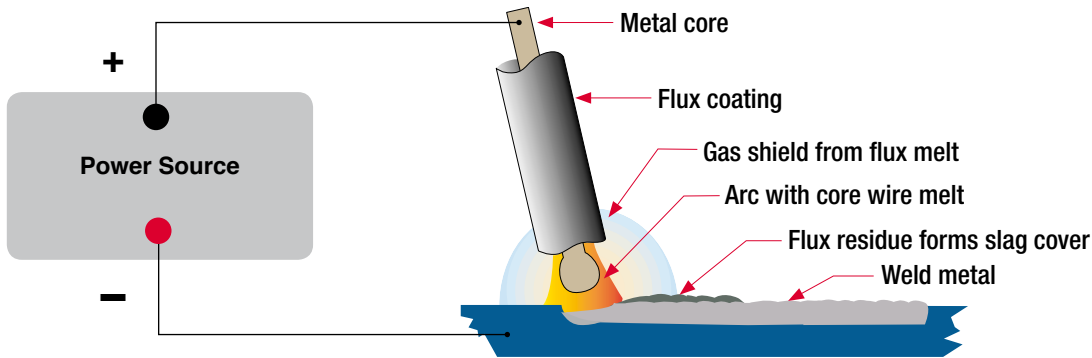

- The arc is initiated by momentarily touching the electrode to the base metal.
- The heat of the arc melts the surface of the base metal to form a molten pool at the end of the electrode.
- The melted electrode metal is transferred across the arc into the molten pool and becomes the deposited weld metal.
- The deposit is covered and protected by a slag which comes from the electrode coating.
- The arc and the immediate area are enveloped by an atmosphere of protective gas.

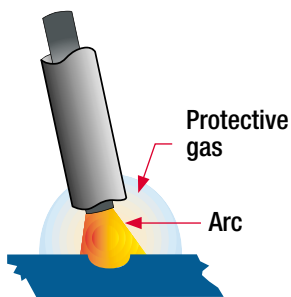

SMAW (stick) electrodes have a solid metal core and a flux coating. These electrodes are identified by the metal core diameter and by a series of letters and numbers. The letters and numbers identify the metal alloy and the intended use of the electrode.

The metal core works as conductor of the current that maintains the arc. The metal core melts and is deposited into the weld pool.

The covering on a shielded metal arc welding electrode is called flux. The flux on the electrode performs many different functions.

These include:

- > *producing a protective gas around the weld area*
- > *providing fluxing elements and deoxidizers*
- > *creating a protective slag coating over the weld as it cools*
- > *establishing arc characteristics*
- > *adding alloying elements.*

Covered electrodes serve many purposes in addition to adding filler metal to the molten pool. These additional functions are provided mainly by the covering on the electrode.

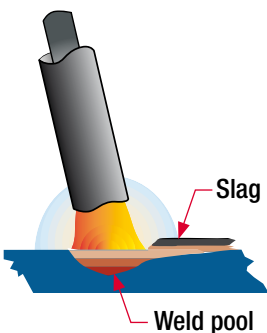

SMAW (STICK) WELDING FUNDAMENTALS

ELECTRODE SELECTION

As a general rule, the selection of an electrode is straight forward, in that it is only a matter of selecting an electrode of similar composition to the parent metal. However, for some metals there is a choice of several electrodes, each of which has particular properties to suit specific classes of work. It is recommended that you consult your welding equipment supplier for the correct selection of electrode.

ELECTRODE SIZE

The size of the electrode generally depends on the thickness of the section being welded, and the thicker the section the larger the electrode required. The table gives the maximum size of electrodes that may be used for various thicknesses of section based on using a general purpose type 6013 electrode.

ELECTRODE SIZE

Average Thickness of Material		Maximum Recommended Electrode Diameter	
0.03 – 0.07 inches	0.75 – 2mm	3/32 inch	2.4mm
0.07 – 0.19 inches	2 – 4.8mm	1/8 inch	3.2mm
0.19 – 0.31 inches	4.8–8mm	5/32 inch	4 mm

WELDING CURRENT (AMPERAGE)

Correct current selection for a particular job is an important factor in stick welding. With the current set too low, difficulty can be experienced in striking and maintaining a stable arc. The electrode tends to stick to the work, penetration is poor and beads with a distinct rounded profile will be deposited. Too high current is accompanied by overheating of the electrode resulting in undercut and burning through of the base metal and producing excessive spatter. Normal current for a particular job may be considered as the maximum which can be used without burning through the work, over-heating the electrode or producing a rough spattered surface. The table shows current ranges generally recommended for a general purpose type 6013 electrode.

WELDING CURRENT (AMPERAGE)

Electrode Size		Current Range
3/32 inch	2.4mm	60 – 100 amps
1/8 inch	3.2mm	100 – 130 amps
5/32 inch	4 mm	130 – 165 amps

ARC LENGTH

To strike the arc, the electrode should be gently scraped on the work until the arc is established. There is a simple rule for the proper arc length; it should be the shortest arc that gives a good surface to the weld. An arc too long reduces penetration, produces spatter and gives a rough surface finish to the weld. An excessively short arc will cause sticking of the electrode and result in poor quality welds. General rule of thumb for down hand welding is to have an arc length no greater than the diameter of the electrode.

General rule of thumb for down hand welding is to have an arc length no greater than the diameter of the electrode.

ELECTRODE ANGLE

The angle that the electrode makes with the work is important to ensure a smooth, even transfer of metal. When welding in down hand, fillet, horizontal or overhead the angle of the electrode is generally between 5 and 15 degrees towards the direction of travel. When vertical up welding the angle of the electrode should be between 80 and 90 degrees to the work piece.

TRAVEL SPEED

The electrode should be moved along in the direction of the joint being welded at a speed that will give the size of run required. At the same time, the electrode is fed downwards to keep the correct arc length at all times. Excessive travel speeds lead to poor fusion, lack of penetration, etc., while too slow a rate of travel will frequently lead to arc instability, slag inclusions and poor mechanical properties.

Excessive travel speeds lead to poor fusion, lack of penetration, etc., while too slow a rate of travel will frequently lead to arc instability, slag inclusions and poor mechanical properties.

MATERIAL AND JOINT PREPARATION

The material to be welded should be clean and free of any moisture, paint, oil, grease, mill scale, rust or any other material that will hinder the arc and contaminate the weld material. Joint preparation will depend on the method used, including sawing, punching, shearing, machining, flame cutting and others. In all cases edges should be clean and free of any contaminants. The type of joint will be determined by the chosen application.







TUNGSTEN ELECTRODES

Tungsten is a rare metallic element used for manufacturing TIG welding electrodes. The TIG process relies on tungsten's hardness and high-temperature resistance to carry the welding current to the arc. Tungsten has the highest melting point of any metal at 6,192° F (3,422°C).

Tungsten electrodes are nonconsumable and come in a variety of sizes, they are made from pure tungsten or an alloy of tungsten and other rare earth elements. Choosing the correct tungsten depends on the material being welded, the amount of amps required and whether you are using AC or DC welding current.

Tungsten electrodes are color-coded at the end for easy identification.

Below are the most commonly-used tungsten electrodes.

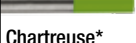
TUNGSTEN ELECTRODE CHARACTERISTICS		
Tungsten	Color Code	Characteristics
Pure	 Green	Provides good arc stability for AC welding. Reasonably good resistance to contamination. Lowest current carrying capacity. Least expensive. Maintains a balled end. Used on transformer based machines only.
2% Ceriated	 Gray	Similar performance to thoriated tungsten. Easy arc starting, good arc stability, long life. Possible replacement for thoriated.
2% Thoriated	 Red	Easier arc starting. Higher current capacity. Greater arc stability. High resistance to weld pool contamination. Difficult to maintain balled end on AC.
1.5% Lanthanated	 Gold	Similar performance to thoriated tungsten. Easy arc starting, good arc stability, long life, high current capacity. 1.5% possible replacement for thoriated. 2% possible replacement for Pure.
2% Lanthanated	 Blue	Similar performance to thoriated tungsten. Easy arc starting, good arc stability, long life, high current capacity. 1.5% possible replacement for thoriated. 2% possible replacement for Pure.
.8% Zirconiated	 White	Excellent for AC welding due to favorable retention of balled end, high resistance to contamination, and good arc starting. Preferred when tungsten contamination of weld is intolerable. Possible replacement for Pure.
LaYzr™	 Chartreuse*	Best for use on automated or robotic applications. Runs cooler than 2% Thoriated with longer life. Low to medium amperage range.

*Substitute for Purple (Same oxide blend).

		TUNGSTEN ELECTRODE CURRENT RANGES				
		TYPICAL CURRENT RANGE				
		Direct Current, DC		Alternating Current, AC		
		DCEN	70% Penetration		(50/50) Balanced Wave, AC	
Tungsten Diameter in inches (mm)	Gas Cup (Inside Diameter)	Ceriated	Zirconiated	Ceriated	Zirconiated	Ceriated
		Thoriated		Thoriated	Pure	Thoriated
		Lanthanated		Lanthanated	LaYzr™	Lanthanated
		LaYzr™		LaYzr™		LaYzr™
.040" (1.0mm)	#6 (3/8")	15–80 amps	20–60 amps	15–80 amps	10–30 amps	20–60 amps
1/16" (1.6mm)	#6 (3/8")	70–150 amps	50–100 amps	70–150 amps	30–80 amps	60–120 amps
3/32" (2.3mm)	#8 (1/2")	150–250 amps	100–160 amps	140–235 amps	60–130 amps	100–180 amps
1/8" (3.2mm)	#8 (1/2")	250–400 amps	150–200 amps	225–325 amps	100–180 amps	160–250 amps

All values are based on the use of Argon as a shielding gas. Other current values may be employed depending on the shielding gas, type of equipment, and application. DCEN = Direct Current Electrode Negative (Straight Polarity)

TUNGSTEN PREPARATION

Always use diamond wheels when grinding and cutting tungsten. While tungsten is a very hard material, the surface of a diamond wheel is harder, and this makes for smooth grinding. Grinding without diamond wheels, such as aluminum oxide wheels, can lead to jagged edges, imperfections, or poor surface finishes not visible to the eye that will contribute to weld inconsistency and weld defects.

Always grind the tungsten in a longitudinal direction on the grinding wheel. Tungsten electrodes are manufactured with the molecular structure of the grain running lengthwise and thus grinding crosswise is "grinding against the grain." If electrodes are ground crosswise, the electrons have to jump across the grinding marks and the arc can start before the tip and wander. Grinding longitudinally with the grain, the electrons flow steadily and easily to the end of the tungsten tip. The arc starts straight and remains narrow, concentrated, and stable.

TUNGSTEN GRINDING



Use a medium (60 grit or finer)

- Grind longitudinally (never radially)
- Truncate (blunt) end
- Diameter of flat spot determines amperage capacity

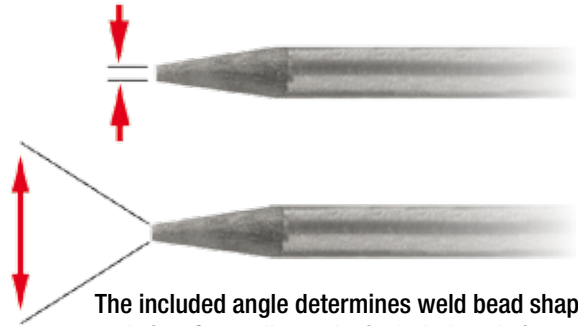

The included angle determines weld bead shape and size. Generally, as the included angle increases, penetration increases and bead width decreases.

TUNGSTEN TIP PREPARATION

DC TIG WELDING

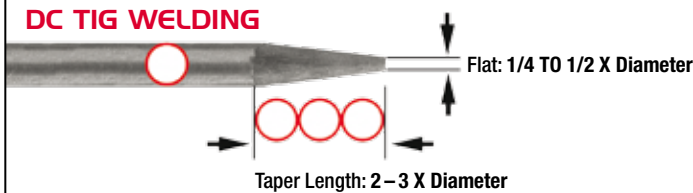

AC TIG WELDING

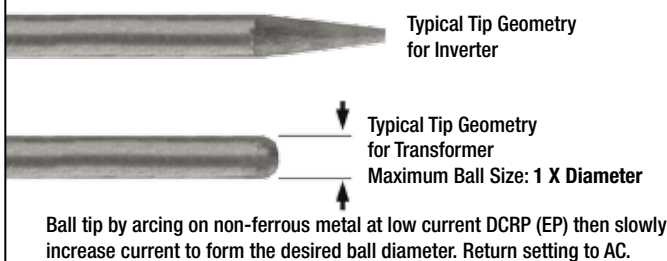

TUNGSTEN EXTENSION

STANDARD PARTS

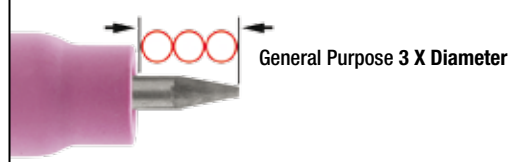

GAS LENS PARTS

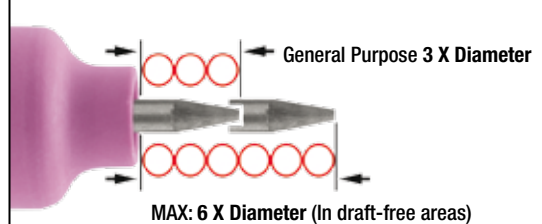

TUNGSTEN ELECTRODE TIP SHAPES AND CURRENT RANGES

ELECTRODE DIAMETER		DIAMETER AT TIP		INCLUDED ANGLE	CURRENT RANGE	PULSED CURRENT RANGE
Millimeters	Inches	Millimeters	Inches			
1.0mm	.040"	.125mm	.005"	12°	2-15 amps	2-25 amps
1.0mm	.040"	.250mm	.010"	20°	5-30 amps	5-60 amps
1.6mm	1/16"	.500mm	.020"	25°	8-50 amps	8-100 amps
1.6mm	1/16"	.800mm	.030"	30°	10-70 amps	10-140 amps
2.4mm	3/32"	.800mm	.030"	35°	12-90 amps	12-180 amps
2.4mm	3/32"	1.100mm	.045"	45°	15-150 amps	15-250 amps
3.2mm	1/8"	1.100mm	.045"	60°	20-200 amps	20-300 amps
3.2mm	1/8"	1.500mm	.060"	90°	25-250 amps	25-350 amps

TUNGSTEN PREPARATION AC / DC TIG WELDING

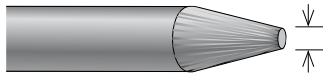

Flat spot diameter

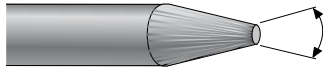

Included angle

The risk of injury when hand (manually) grinding a very hard brittle material like tungsten is quite high. It is important to always follow standard safety guidelines when operating high speed grinding equipment.

ELECTRODE INCLUDED ANGLE/TAPER FOR SQUARE WAVE TIG WELDING

Tungsten electrodes for welding should be ground longitudinally and concentrically with diamond wheels to a specific included angle in conjunction with the tip/flat preparation. Different angles produce different arc shapes and offer different weld penetration capabilities.

In general, blunter electrodes that have a larger included angle provide the following benefits:

- Last longer
- Have better weld penetration
- Have a narrower arc shape
- Can handle more amperage without eroding

Sharper electrodes with smaller included angle provide:

- Less penetration
- Have a wider arc

The included angle determines weld bead shape and size. Generally, as the included angle increases, penetration increases and bead width decreases.

SAFETY WITH TUNGSTEN ELECTRODES

Tungsten welding electrodes should never be manually ground on an abrasive belt or wheel (particularly silicone carbide). Always use diamond wheels when grinding and cutting tungsten electrodes. The risk of injury when hand (manually) grinding a very hard brittle material like tungsten is quite high. It is important to always follow standard safety guidelines when operating high speed grinding equipment.

- Wear approved safety glasses
- No loose clothing which may get caught in moving parts
- Wear protective hair covering to contain long hair
- Wear safety shoes with non-slip sole
- A vacuum system is recommended to remove tungsten, especially thorium dust
- Never operate power tools when tired, intoxicated, or taking medication that causes drowsiness

The most common injuries when using the manual tungsten electrode grinder are eye and finger related. Holding and grinding the tungsten electrode by hand has resulted in burned fingers, laceration to fingers and splintered tungsten electrodes in hand or fingers. Eye injury generally occurs from manually grinding tungsten electrodes without a safety shield or safety glasses. Small slivers of tungsten electrode may become stuck in the operator's eye.

SMAW (STICK) WELDING TROUBLESHOOTING

The following chart addresses some of the common problems of SMAW (Stick) welding. In all cases of equipment malfunction, the manufacturer's recommendations should be strictly adhered to and followed.

1: No arc	
POSSIBLE REASON	SUGGESTED REMEDY
Incomplete welding circuit	Confirm that the ground clamp is connected. Check all cable connections.
Wrong mode selected	Check the STICK selector switch is selected.
No power supply	Check that the machine is switched on and has a power supply.
2: Porosity – small cavities or holes resulting from gas pockets in weld metal.	
POSSIBLE REASON	SUGGESTED REMEDY
Arc length too long	Shorten the arc length.
Work piece dirty, contaminated or moisture	Remove moisture and materials like paint, grease, oil, and dirt, including mill scale from base metal.
Damp electrodes	Use only dry electrodes.
3: Excessive Spatter	
POSSIBLE REASON	SUGGESTED REMEDY
Amperage too high	Decrease the amperage or choose a larger electrode.
Arc length too long	Shorten the arc length.
4: Weld sits on top, lack of fusion	
POSSIBLE REASON	SUGGESTED REMEDY
Insufficient heat input	Increase the amperage.
Work piece dirty, contaminated or moisture	Remove moisture and materials like paint, grease, oil, and dirt, including mill scale from base metal.
Poor welding technique	Use the correct welding technique or seek assistance for the correct technique.
5: Lack of penetration	
POSSIBLE REASON	SUGGESTED REMEDY
Insufficient heat input	Increase the amperage.
Poor welding technique	Use the correct welding technique or seek assistance for the correct technique.
Poor joint preparation	Check the joint design and fit up, make sure the material is not too thick. Seek assistance for the correct joint design and fit up.
6: Excessive penetration –burn through	
POSSIBLE REASON	SUGGESTED REMEDY
Excessive heat input	Reduce the amperage.
Incorrect travel speed	Try increasing the weld travel speed.
7: Uneven weld appearance	
POSSIBLE REASON	SUGGESTED REMEDY
Unsteady hand, wavering hand	Use two hands where possible to steady up, practice your technique.
8: Distortion – movement of base metal during welding	
POSSIBLE REASON	SUGGESTED REMEDY
Excessive heat input	Reduce the amperage.
Poor welding technique	Use the correct welding technique or seek assistance for the correct technique.
Poor joint preparation and or joint design	Check the joint design and fit up, make sure the material is not too thick. Seek assistance for the correct joint design and fit up.
9: Electrode welds with different or unusual arc characteristic	
POSSIBLE REASON	SUGGESTED REMEDY
Incorrect polarity	Change the polarity, check the electrode manufacturer for correct polarity.

GTAW (TIG) WELDING TROUBLESHOOTING

The following chart addresses some of the common problems of TIG welding. In all cases of equipment malfunction, the manufacturer's recommendations should be strictly adhered to and followed.

1: Tungsten burning away quickly	
POSSIBLE REASON	SUGGESTED REMEDY
Incorrect Gas	Check that pure Argon is being used.
No gas	Check the gas cylinder contains gas and is connected.
Inadequate gas flow	Check the gas is connected, check hoses, gas valve and torch are not restricted. Set the gas flow between 15–25 CFH (7–12 LMN) flow rate.
Back cap not fitted correctly	Make sure the torch back cap is fitted so that the o-ring is inside the torch body.
Torch connected to DC +	Connect the torch to the DC – output terminal.
Incorrect tungsten being used	Check and change the tungsten type if necessary.
Tungsten being oxidized after weld is finished	Keep shielding gas flowing 10–15 seconds after arc stoppage. 1 second for each 10 amps of weld current.
Tungsten melting back into the nozzle on AC welding	Check that correct type of tungsten is being used. Check the balance control is not set too high — reduce to a lower setting.
2: Contaminated tungsten	
POSSIBLE REASON	SUGGESTED REMEDY
Touching tungsten into the weld pool	Keep tungsten from contacting weld puddle. Raise the torch so that the tungsten is off of the work piece 1/8"–1/4" (3.2–6.35mm).
Touching the filler wire to the tungsten	Keep the filler wire from touching the tungsten during welding, feed the filler wire into the leading edge of the weld pool in front of the tungsten.
Tungsten melting into the weld pool	Check that correct type of tungsten is being used. Too much current for the tungsten size so reduce the amps or change to a larger tungsten.
3: Porosity — poor weld appearance and color	
POSSIBLE REASON	SUGGESTED REMEDY
Incorrect Gas	Check that pure Argon is being used.
Inadequate gas flow / gas leaks	Check the gas is connected, check hoses, gas valve and torch are not restricted. Set the gas flow between 15–25 CFH (7–12 LMN) flow rate. Check hoses and fittings for holes, leaks, etc.
Moisture on the base metal	Remove all moisture from base metal before welding.
Contaminated base metal	Remove materials like paint, grease, oil, and dirt, including mill scale from base metal.
Contaminated filler wire	Remove all grease, oil, or moisture from filler metal.
Incorrect filler wire	Check the filler wire and change if necessary.
4: Yellowish residue / smoke on the alumina nozzle & discolored tungsten	
POSSIBLE REASON	SUGGESTED REMEDY
Incorrect Gas	Use pure Argon gas.
Inadequate gas flow	Set the gas flow between 15–25 CFH (7–12 LMN) flow rate.
Inadequate post flow gas	Increase the post flow gas time.
Alumina gas nozzle too small for size of tungsten being used	Increase the size of the alumina gas nozzle.
5: Unstable arc during DC welding	
POSSIBLE REASON	SUGGESTED REMEDY
Torch connected to DC +	Connect the torch to the DC – output terminal.
Contaminated base metal	Remove materials like paint, grease, oil, and dirt, including mill scale from base metal.
Tungsten is contaminated	Remove 3/8" (10mm) of contaminated tungsten and re-grind the tungsten.
Arc length too long	Lower torch so that the tungsten is off of the work piece 1/8"–1/4" (3.2–6.35mm).
6: Unstable arc during AC welding	
POSSIBLE REASON	SUGGESTED REMEDY
Incorrect gas or inadequate gas flow	Check that pure Argon is being used. Check the gas is connected, check hoses, gas valve and torch are not restricted. Set the gas flow between 15–25 CFH (7–12 LMN) flow rate flow rate.
Incorrect tungsten being used	Check and change the tungsten type if necessary.
Tungsten is contaminated	Remove 3/8" (10mm) of contaminated tungsten and re-grind the tungsten.
Improperly prepared tungsten	Use a pointed tungsten with AC Squarewave inverter machines. The point will round off after welding.
Excessive rectification in the base metal	Adjust balance control. Increase travel speed. Add filler wire during welding.

GTAW (TIG) WELDING TROUBLESHOOTING

7: HF present but no welding power	
POSSIBLE REASON	SUGGESTED REMEDY
Incomplete welding circuit	Confirm that the ground clamp is connected. Check all cable connections. Check that the power cable is not separated.
No gas	Check the gas is connected and cylinder valve open, check hoses, gas valve and torch are not restricted. Set the gas flow between 15–25 CFH (7–12 LMN) flow rate.
Tungsten melting into the weld pool	Check that correct type of tungsten is being used. Too much current for the tungsten size so reduce the amps or change to a larger tungsten.
8: Arc wanders during DC welding	
POSSIBLE REASON	SUGGESTED REMEDY
Poor gas flow	Check and set the gas flow between 15–25 CFH (7–12 LMN) flow rate.
Incorrect arc length	Lower torch so that the tungsten is off of the work piece 1/8"–1/4" (3.2–6.35mm).
Tungsten incorrect or in poor condition	Check that correct type of tungsten is being used. Remove 3/8" (10mm) from the weld end of the tungsten and re-sharpen the tungsten.
Poorly prepared tungsten	Grind marks should run lengthwise with tungsten, not circular. Use proper grinding method and wheel.
Contaminated base metal	Remove contaminating materials like paint, grease, oil, and dirt, including mill scale from base metal.
Contaminated filler wire	Remove all grease, oil, or moisture from filler metal.
Incorrect filler wire	Check the filler wire and change if necessary.
9: Arc wanders during AC welding	
POSSIBLE REASON	SUGGESTED REMEDY
Inadequate gas flow	Set the gas flow between 15–25 CFH (7–12 LMN) flow rate.
Incorrect arc length	Set the torch so that the tungsten is off of the work piece 1/8"–1/4" (3.2–6.35mm).
Tungsten is contaminated	Remove 3/8" (10mm) of contaminated tungsten and re-grind the tungsten. Use a pointed tungsten with AC squarewave inverter machines. The point will round off after welding.
Incorrect tungsten size and or tungsten being used	Check and change the size and or the tungsten if required.
Excessive rectification in the base metal	Increase balance control. Increase travel speed. Add filler wire during welding.
Contaminated base metal	Remove contaminating materials like paint, grease, oil, and dirt, including mill scale from base metal.
10: Arc difficult to start or will not start DC welding	
POSSIBLE REASON	SUGGESTED REMEDY
Incorrect machine set up	Check machine set up is correct.
No gas, incorrect gas flow	Check the gas is connected and cylinder valve open, check hoses, gas valve and torch are not restricted. Set the gas flow between 15–25 CFH (7–12 LMN) flow rate.
Tungsten is contaminated	Remove 3/8" (10mm) of contaminated tungsten and re-grind the tungsten.
Incorrect tungsten size and or tungsten being used	Check and change the size and or the tungsten if required.
Loose connection	Check all connectors and tighten.
Ground clamp not connected to work	Connect the ground clamp directly to the work piece wherever possible.
Loss of high frequency	Check torch and cables for cracked insulation or bad connections.
11: Arc difficult to start or will not start AC welding	
POSSIBLE REASON	SUGGESTED REMEDY
Incorrect machine set up	Check machine set up is correct.
No gas, incorrect gas flow	Check the gas is connected and cylinder valve open, check hoses, gas valve and torch are not restricted. Set the gas flow between 15–25 CFH (7–12 LMN) flow rate.
Incorrect tungsten size and or tungsten being used	Check and change the size and or the tungsten if required.
Tungsten is contaminated	Remove 3/8" (10mm) of contaminated tungsten and re grind the tungsten. Use a pointed tungsten with AC squarewave inverter machines. The point will round off after welding.
Loose connection	Check all connectors and tighten.
Ground clamp not connected to work	Connect the Ground clamp directly to the work piece wherever possible.
Loss of high frequency	Check torch and cables for cracked insulation or bad connections.

CK17 TIG TORCH PACKAGES

INCLUDED WITH THE MT200-AC/DC WELDING MACHINE

CK17 FLEX				
HEAD STYLE	CABLE	CABLE LENGTH	STANDARD #	SUPER-FLEX #
Flex Head	1 Piece	12½ ft. (3.8m)	CK17-12-R FX	CK17-12-RSF FX
		25 ft. (7.6m)	CK17-25-R FX	CK17-25-RSF FX



- Gas-Cooled
- 150 amp ACHF or DCSP @ 100%
- 8-1/8" (20.6cm) 5 oz (141gm)
- 3 Series Head Accessories

ADDITIONAL CK WORLDWIDE COMPATIBLE TORCHES

CK17 RIGID				
HEAD STYLE	CABLE	CABLE LENGTH	STANDARD #	SUPER-FLEX #
Rigid Head	1 Piece	12½ ft. (3.8m)	CK17-12-R RG	CK17-12-RSF RG
		25 ft. (7.6m)	CK17-25-R RG	CK17-25-RSF RG













CK17RG-T THREAD-ON HANDLE				
HEAD STYLE	CABLE	CABLE LENGTH	STANDARD #	SUPER-FLEX #
Rigid Head	1 Piece	12½ ft. (3.8m)	CK17-12-R RG-T	CK17-12-RSFRG-T
		25 ft. (7.6m)	CK17-25-R RG-T	CK17-25-RSFRG-T

CK17P PENCIL (RIGID)				
HEAD STYLE	CABLE	CABLE LENGTH	STANDARD #	SUPER-FLEX #
Rigid Head	1 Piece	12½ ft. (3.8m)	CK17P-12-R	CK17P-12-RSF
		25 ft. (7.6m)	CK17P-25-R	CK17P-25-RSF

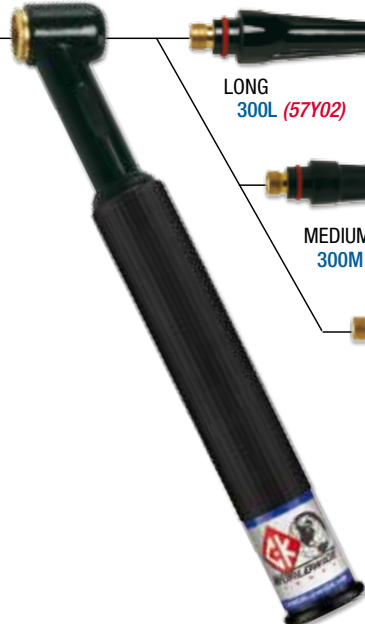

CK17 / 3-SERIES TORCH HEAD COMPONENTS

CUP	COLLET BODY	COLLET	HEATSHIELD	TORCH	BACKCAP
 ALUMINA 3A4 (10N50) 3A5 (10N49) 3A6 (10N48) 3A7 (10N47) 3A8 (10N46) 3A10 (10N45) 3A12 (10N44)	 STANDARD 3CB20 (10N29) 3CB40 (10N30) 3CB116 (10N31) 3CB332 (10N32) 3CB418 (10N28) 3CB532 (406488)	 STANDARD 3C20 (10N21) 3C40 (10N22) 3C116 (10N23) 3C332 (10N24) 3C418 (10N25) 3C532 (54N20)  WEDGE 3C040GS 3C418GS 3C116GS 3C532GS 3C332GS  REVERSE 7C20 7C332 7C40 7C418 7C116 7C532	 STANDARD 300HS		 LONG 300L (57Y02)  MEDIUM 300M (34015)  SHORT 300S (57Y04)

CK17 TIG TORCH CABLES & CONNECTORS

POWER CABLES/HOSES

1 PIECE SUPER-FLEX POWER CABLE *(INCLUDED WITH MT200-AC/DC)*



1 PIECE STANDARD POWER CABLE



LENGTH	STANDARD	SUPER-FLEX
	1 PIECE CABLE	1 PIECE CABLE
12-1/2 ft. (3.8m)	57Y01R	57Y01RSF
25 ft. (7.6m)	57Y03R	57Y03RSF

DINSE CONNECTOR



DINSE 35
(1/2" 12.8mm)



TORCH BODIES / HANDLES

PART #	STYLE
CK17 RG	RIGID
CK17 FX	FLEX
CK17P	PENCIL



REPLACEMENT HANDLE
Part # HS

AK-3 ACCESSORY KIT (FOR 3-SERIES TORCHES)



ACCESSORY	SIZE — QTY. 1 EACH	PART #
BACKCAPS	Long	300L (57Y02)
	Short	300S (57Y04)
COLLETS	1/16" (1.6mm)	3C116 (10N23)
	3/32" (2.4mm)	3C332 (10N24)
	1/8" (3.2mm)	3C418 (10N25)
COLLET BODIES	1/16" (1.6mm)	3CB116 (10N31)
	3/32" (2.4mm)	3CB332 (10N32)
	1/8" (3.2mm)	3CB418 (10N28)
ALUMINA CUPS	#5 (5/16" 8.0mm)	3A5 (10N49)
	#6 (3/8" 9.6mm)	3A6 (10N48)
	#8 (1/2" 12.8mm)	3A8 (10N46)
2% CERIATED TUNGSTEN	1/16" (1.6mm) x 7"	T1167GC2
	3/32" (2.4mm) x 7"	T3327GC2
	1/8" (3.2mm) x 7"	T187GC2

TUNGSTEN ELECTRODE OPTIONS:

2% THORIATED (RED)
EWTh-2/WT20

Principal Oxide: 1.7–2.2% Thorium Oxide

0.8% ZIRCONIATED (WHITE)
EWZr-8/WZ8

Principal Oxide: 0.7–0.9% Zirconium Oxide

1.5% LANTHANATED (GOLD)
EWLa-1.5/WL15

Principal Oxide: 1.3–1.7% Lanthanum Oxide

2% CERIATED (GREY)
FORMERLY ORANGE
EWCe-2/WC20

Principal Oxide: 1.8–2.2% Cerium Oxide

PURE (GREEN) EWP/WP
Principal Oxide: None

2% LANTHANATED (BLUE)
EWLa-2/WL20

Principal Oxide: 1.8–2.2% Lanthanum Oxide

LaYZ™ (CHARTREUSE) EWG
Principal Oxides: 1.5% Lanthanum,
0.8% Yttrium Oxides, 0.8% Zirconium



WARRANTY INFORMATION

WARRANTY

CK Worldwide, Inc. warrants products manufactured by CK Worldwide to be free of defects in materials and workmanship. CK Worldwide limits this warranty to replacement of the product or parts thereof, and excludes liability for injury, property damage or economic loss attributable to product use or misuse. Warranty claims must be made within the specific products valid warranty period.

These terms and conditions supersede and exclude all former and other representations and arrangements relating to any warranties on these products.

WARRANTY PERIOD

We offer the following warranty periods from date of purchase.

MT200-AC/DC WELDING MACHINE

Inverter TIG (Power Source Only) 3 Years
*3 year warranty on transformers, inductor and rectifier.
1 year warranty on PCB and all other components.*

Foot Pedal, Gas Regulator, Gas Hose and
Ground Cable Assembly 3 Months

This only covers manufacturer's defaults on all accessories for the first three months after date of purchase.

MAKING A CLAIM

If you wish to make a claim under this Warranty, you should:

- Return the product to the point of purchase either in person or on a prepaid courier; or
- Contact us by telephone (+1) 253-854-5820
Monday – Friday 7:00 AM – 3:30 PM (USA Pacific Time)
or email help@CKworldwide.com
- When returned, the product must be accompanied with the original invoice including the purchase price and disclosing the purchase date.
- Must fill out Warranty Form including all applicable information.
- All costs of installation, cartage, freight, traveling expenses, hiring tools and insurance are paid by the customer.
- To the extent permitted by law, our total liability for loss or damage of every kind related to the product in any way whatsoever is limited to the amount paid to the retailer by you for the product or the value of the product.

No responsibility will be taken for products lost, damaged or mislaid while in transit.

WARRANTY EXCLUSIONS

This Warranty covers material and faulty workmanship defects only. This Warranty does not cover damage caused by:

- Normal wear and tear due to usage
- Failure to follow manual guidelines for machine use
- Failure to clean or improper cleaning of the product
- Failure to maintain the equipment such as regular services etc.
- Incorrect voltage or non-authorized electrical connections
- Improper installation
- Use of non-authorized/non-standard parts
- Abnormal product performance caused by any ancillary equipment interference or other external factors
- Failure or any breakage caused by overload, dropping or abusive treatment or use by the customer
- Repair, modifications or other work carried out on the product other than by an authorized CK Worldwide dealers

This Warranty does not cover products purchased:

- From a non-authorized Dealer (such as purchases from unauthorized retailers and purchases over the Internet from unauthorized local/international sellers or sites such as EBay)
- At an auction;
- From a private seller unless it is a manufacturing fault, this Warranty does not apply to any products sold to Hire Companies.

These conditions may only be varied with the written approval of CK Worldwide, Inc.

REMEMBER TO RETAIN YOUR ORIGINAL INVOICE FOR PROOF OF PURCHASE.

Tungsten Electrode Grinder

- Enclosed electrode grinder minimizes grinding dust exposure to both the user and the environment
- Standard head for diameters: .040" (1.0mm) 1/16" (1.6mm), 3/32" (2.4mm), and 1/8" (3.2mm)
- Angles adjustable from 20°–60°
- Consistent tip geometry
- Eliminate grinding wheel contamination
- Both sides of grinding disks are coated with diamond powder

ORDER #	DESCRIPTION
TS10	120 V GRINDER (Includes TS3-HB)
TS10-230	230 V GRINDER (Includes TS3-HB)
TS3-W	Replacement Wheel
TS3-HB	Grinder Head .040"–1/8" (1.0mm – 3.2mm)
TS3-HR	Grinder Head 1/8" (3.2mm), 5/32" (4.0mm), 3/16" (4.8mm), 1/4" (6.4mm)
TS3-STK	Short Tungsten Kit (TS3-HR required)



Adjustable head design allows GRINDING DISCS TO LAST 3 TIMES LONGER!!



Patented Flexible Purge Chamber

- Less argon required
- Collapsible, easily stored
- Multiple accessory & glove ports
- Less expensive
- Less time to fill
- Vacuum drawn
- Facilitates welding grade atmosphere
- 30" (76.8cm) diameter

ORDER #PC2000-24



Tungsten Stick-Out Gauge

- Consistent stick-out adds quality to every weld
- Great for orbital welders, instructors, weld inspectors
- Insures correct stick-out for gas nozzle being used
- Eliminates tungsten contamination by keeping the tungsten in the gas stream
- Correct stick-out insures undue stress on the ceramic gas nozzle



ORDER # TG1

Electronic Welding Helmet

- 4 Sensors for out of position welding
- High quality LCD and multilayer optical interference filter provide clear view and permanent UV/IR protection up to DIN 15.
- Power supply by solar cells and Lithium batteries (replaceable).
- Digital low battery warning indicator.
- Mask made of high impact resistant special nylon.
- Ample mask space, especially for ears and neck.
- Adaptor for plastic magnifying lens.
- CE EN 379, ANSI Z87.1, CSA Z94.3
- Standard 4-1/2" x 5-1/4" (11.4cm x 13.3cm) cover lens.

ORDER # CK-ADWH





TRADEMARK NOTICES:

Gas Saver™, Safe-Loc™, Flex-Loc™, Super-Flex™, Trim-Line™, Max-Flo™, Fail-Safe™, Steady-Grip™, and LaYZr™ are trademarks of CK Worldwide Inc.

Phone: 1.800.426.0877 Fax: 1.800.327.5038

CK Worldwide, Inc. PO Box 1636, Auburn, WA 98071 USA

www.CKWORLDWIDE.com

CONNECT WITH US ON:

