



OM-253 918B

2012-02

Processes



Multiprocess Welding

Description



MPi 220P CE

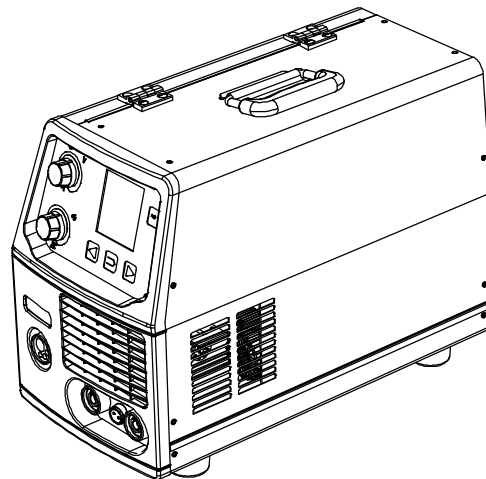

Visit our website at
www.MillerWelds.com

OWNER'S MANUAL

File: Multiprocess



From Miller to You

Thank you and congratulations on choosing Miller. Now you can get the job done and get it done right. We know you don't have time to do it any other way.

That's why when Niels Miller first started building arc welders in 1929, he made sure his products offered long-lasting value and superior quality. Like you, his customers couldn't afford anything less. Miller products had to be more than the best they could be. They had to be the best you could buy.

Today, the people that build and sell Miller products continue the tradition. They're just as committed to providing equipment and service that meets the high standards of quality and value established in 1929.

This Owner's Manual is designed to help you get the most out of your Miller products. Please take time to read the Safety precautions. They will help you protect yourself against potential hazards on the worksite. We've made installation and operation quick and easy. With Miller you can count on years of reliable service with proper maintenance. And if for some reason the unit needs repair, there's a Troubleshooting section that will help you figure out what the problem is. The parts list will then help you to decide which exact part you may need to fix the problem. Warranty and service information for your particular model are also provided.



Miller Electric manufactures a full line of welders and welding related equipment. For information on other quality Miller products, contact your local Miller distributor to receive the latest full line catalog or individual catalog sheets.



Working as hard as you do – every power source from Miller is backed by the most hassle-free warranty in the business.



TABLE OF CONTENTS

SECTION 1 – SAFETY PRECAUTIONS - READ BEFORE USING	1
1-1. Symbol Usage	1
1-2. Arc Welding Hazards	1
1-3. Additional Symbols For Installation, Operation, And Maintenance	3
1-4. California Proposition 65 Warnings	4
1-5. Principal Safety Standards	4
1-6. EMF Information	4
SECTION 2 – DEFINITIONS	5
2-1. WEEE Label	7
2-2. Symbols And Definitions	8
SECTION 3 – SPECIFICATIONS	9
3-1. Important Information Regarding CE Products (Sold Within The EU)	9
3-2. Information On Electromagnetic Compatibility (EMC)	9
3-3. Specifications	9
3-4. Duty Cycle And Overheating	10
3-5. Volt-Ampere Curves	11
SECTION 4 – INSTALLATION	12
4-1. Serial Number And Rating Label Location	12
4-2. Selecting A Location	12
4-3. Installing Gas Supply	13
4-4. Weld Output Terminals And Selecting Cable Sizes*	14
4-5. Process/Polarity Table	14
4-6. Changing Polarity	15
4-7. Installing Wire Spool And Adjusting Hub Tension	16
4-8. Changing Drive Rolls And Wire Inlet Guide	17
4-9. Aligning Drive Rolls and Wire Guide	18
4-10. Electrical Service Guide	19
4-11. Connecting 230 VAC Single Phase Input Power	20
4-12. Threading Welding Wire And Adjusting Pressure Roll Tension	21
SECTION 5 – OPERATION	22
5-1. Controls	22
5-2. Preparing Unit For Stick Welding	23
5-3. Preparing Unit For TIG Welding	24
5-4. 2T – 4T Trigger Mode Selection (TIG Process)	25
5-5. Preparing Unit For Manual MIG (GMAW And FCAW) Welding Process	26
5-6. Manual MIG Welding Set-Up Menu	27
5-7. Trigger Mode And Spot Time Selection (MIG Process)	29
5-8. Preparing Unit For Synergic MIG (GMAW And FCAW) Welding Process	30
5-9. Synergic MIG Welding Set-Up Menu	31
5-10. Preparing Unit For Synergic Pulsed MIG (GMAW And FCAW) Welding Process	33
5-11. Synergic Pulsed MIG Welding Set-Up Menu	35
5-12. 4T Trigger Set-Up Menu (Synergic Pulsed MIG Welding Only)	36
5-13. Welding Wire Loading Settings	37
5-14. Resetting Unit To Factory Default Settings	38
5-15. Loading A Program	38
5-16. Operator Point MIG Parameters Loading	39
5-17. Rated Supply Current I1 = 16 Amps Setting	40
5-18. Basic Set-Up Menu Parameters Settings	41

TABLE OF CONTENTS

SECTION 6 – MAINTENANCE & TROUBLESHOOTING	42
6-1. Routine Maintenance	42
6-2. Welding Gun And Wire Drive Assembly	42
6-3. Unit Overload	42
6-4. Troubleshooting	43
SECTION 7 – ELECTRICAL DIAGRAMS	46
SECTION 8 – MIG WELDING (GMAW) GUIDELINES	48
8-1. Typical MIG Process Connections	48
8-2. Typical MIG Process Control Settings	49
8-3. Holding And Positioning Welding Gun	50
8-4. Conditions That Affect Weld Bead Shape	51
8-5. Gun Movement During Welding	52
8-6. Poor Weld Bead Characteristics	52
8-7. Good Weld Bead Characteristics	52
8-8. Troubleshooting – Excessive Spatter	53
8-9. Troubleshooting – Porosity	53
8-10. Troubleshooting – Excessive Penetration	53
8-11. Troubleshooting – Lack Of Penetration	54
8-12. Troubleshooting – Incomplete Fusion	54
8-13. Troubleshooting – Burn-Through	54
8-14. Troubleshooting – Waviness Of Bead	55
8-15. Troubleshooting – Distortion	55
8-16. Common MIG Shielding Gases	56
8-17. Troubleshooting Guide For Semiautomatic Welding Equipment	56
SECTION 9 – STICK WELDING (SMAW) GUIDELINES	58
SECTION 10 – SELECTING AND PREPARING A TUNGSTEN FOR DC OR AC WELDING WITH INVERTER MACHINES	65
10-1. Selecting Tungsten Electrode (Wear Clean Gloves To Prevent Contamination Of Tungsten)	65
10-2. Preparing Tungsten Electrode For DC Electrode Negative (DCEN) Welding Or AC Welding With Inverter Machines	65
SECTION 11 – GUIDELINES FOR TIG WELDING (GTAW)	66
11-1. Positioning The Torch	66
11-2. Torch Movement During Welding	67
11-3. Positioning Torch Tungsten For Various Weld Joints	67
SECTION 12 – PARTS LIST	68
WARRANTY	



DECLARATION OF CONFORMITY

for European Community (CE marked) products.

ITW Welding Products Italy S.r.l Via Privata Iseo 6/E, 20098 San Giuliano M.se, (MI) Italy declares that the product(s) identified in this declaration conform to the essential requirements and provisions of the stated Council Directive(s) and Standard(s).

Product/Apparatus Identification:

Product	Stock Number
MPi 220P 230VAC	059016014

Council Directives:

2006/95/EC Low Voltage

2004/108/EC Electromagnetic Compatibility

Standards:

IEC 60974-1 Arc Welding Equipment - Welding Power Sources: edition 3, 2005-07.

IEC 60974-5 Arc Welding Equipment – Wire Feeders: edition 2, 2007-11.

IEC 60974-10 Arc Welding Equipment - Electromagnetic Compatibility Requirements: edition 2.0, 2007-08.

EN 50445:2008 Product family standard to demonstrate compliance of equipment for resistance welding, arc welding and allied processes with the basic restrictions related to human exposure to electromagnetic fields (0Hz-300Hz)

EU Signatory:

September 30th, 2011

Massimiliano Lavarini

Date of Declaration

ELECTRONIC ENGINEER R&D TECH. SUPPORT

956 142 896

SECTION 1 – SAFETY PRECAUTIONS - READ BEFORE USING

som 2011-10

 Protect yourself and others from injury — read, follow, and save these important safety precautions and operating instructions.

1-1. Symbol Usage

 **DANGER!** – Indicates a hazardous situation which, if not avoided, will result in death or serious injury. The possible hazards are shown in the adjoining symbols or explained in the text.

 Indicates a hazardous situation which, if not avoided, could result in death or serious injury. The possible hazards are shown in the adjoining symbols or explained in the text.

NOTICE – Indicates statements not related to personal injury.

 Indicates special instructions.



This group of symbols means Warning! Watch Out! ELECTRIC SHOCK, MOVING PARTS, and HOT PARTS hazards. Consult symbols and related instructions below for necessary actions to avoid the hazards.

1-2. Arc Welding Hazards

 The symbols shown below are used throughout this manual to call attention to and identify possible hazards. When you see the symbol, watch out, and follow the related instructions to avoid the hazard. The safety information given below is only a summary of the more complete safety information found in the Safety Standards listed in Section 1-5. Read and follow all Safety Standards.

 Only qualified persons should install, operate, maintain, and repair this unit.

 During operation, keep everybody, especially children, away.



ELECTRIC SHOCK can kill.

Touching live electrical parts can cause fatal shocks or severe burns. The electrode and work circuit is electrically live whenever the output is on. The input power circuit and machine internal circuits are also live when power is on. In semiautomatic or automatic wire welding, the wire, wire reel, drive roll housing, and all metal parts touching the welding wire are electrically live. Incorrectly installed or improperly grounded equipment is a hazard.

- Do not touch live electrical parts.
- Wear dry, hole-free insulating gloves and body protection.
- Insulate yourself from work and ground using dry insulating mats or covers big enough to prevent any physical contact with the work or ground.
- Do not use AC output in damp areas, if movement is confined, or if there is a danger of falling.
- Use AC output ONLY if required for the welding process.
- If AC output is required, use remote output control if present on unit.
- Additional safety precautions are required when any of the following electrically hazardous conditions are present: in damp locations or while wearing wet clothing; on metal structures such as floors, gratings, or scaffolds; when in cramped positions such as sitting, kneeling, or lying; or when there is a high risk of unavoidable or accidental contact with the workpiece or ground. For these conditions, use the following equipment in order presented: 1) a semiautomatic DC constant voltage (wire) welder, 2) a DC manual (stick) welder, or 3) an AC welder with reduced open-circuit voltage. In most situations, use of a DC, constant voltage wire welder is recommended. And, do not work alone!
- Disconnect input power or stop engine before installing or servicing this equipment. Lockout/tagout input power according to OSHA 29 CFR 1910.147 (see Safety Standards).
- Properly install, ground, and operate this equipment according to its Owner's Manual and national, state, and local codes.

- Always verify the supply ground – check and be sure that input power cord ground wire is properly connected to ground terminal in disconnect box or that cord plug is connected to a properly grounded receptacle outlet.
- When making input connections, attach proper grounding conductor first – double-check connections.
- Keep cords dry, free of oil and grease, and protected from hot metal and sparks.
- Frequently inspect input power cord for damage or bare wiring – replace cord immediately if damaged – bare wiring can kill.
- Turn off all equipment when not in use.
- Do not use worn, damaged, undersized, or poorly spliced cables.
- Do not drape cables over your body.
- If earth grounding of the workpiece is required, ground it directly with a separate cable.
- Do not touch electrode if you are in contact with the work, ground, or another electrode from a different machine.
- Do not touch electrode holders connected to two welding machines at the same time since double open-circuit voltage will be present.
- Use only well-maintained equipment. Repair or replace damaged parts at once. Maintain unit according to manual.
- Wear a safety harness if working above floor level.
- Keep all panels and covers securely in place.
- Clamp work cable with good metal-to-metal contact to workpiece or worktable as near the weld as practical.
- Insulate work clamp when not connected to workpiece to prevent contact with any metal object.
- Do not connect more than one electrode or work cable to any single weld output terminal. Disconnect cable for process not in use.

SIGNIFICANT DC VOLTAGE exists in inverter welding power sources AFTER removal of input power.

- Turn Off inverter, disconnect input power, and discharge input capacitors according to instructions in Maintenance Section before touching any parts.



HOT PARTS can burn.

- Do not touch hot parts bare handed.
- Allow cooling period before working on equipment.
- To handle hot parts, use proper tools and/or wear heavy, insulated welding gloves and clothing to prevent burns.



FUMES AND GASES can be hazardous.

Welding produces fumes and gases. Breathing these fumes and gases can be hazardous to your health.

- Keep your head out of the fumes. Do not breathe the fumes.
- If inside, ventilate the area and/or use local forced ventilation at the arc to remove welding fumes and gases.
- If ventilation is poor, wear an approved air-supplied respirator.
- Read and understand the Material Safety Data Sheets (MSDSs) and the manufacturer's instructions for metals, consumables, coatings, cleaners, and degreasers.
- Work in a confined space only if it is well ventilated, or while wearing an air-supplied respirator. Always have a trained watch-person nearby. Welding fumes and gases can displace air and lower the oxygen level causing injury or death. Be sure the breathing air is safe.
- Do not weld in locations near degreasing, cleaning, or spraying operations. The heat and rays of the arc can react with vapors to form highly toxic and irritating gases.
- Do not weld on coated metals, such as galvanized, lead, or cadmium plated steel, unless the coating is removed from the weld area, the area is well ventilated, and while wearing an air-supplied respirator. The coatings and any metals containing these elements can give off toxic fumes if welded.



ARC RAYS can burn eyes and skin.

Arc rays from the welding process produce intense visible and invisible (ultraviolet and infrared) rays that can burn eyes and skin. Sparks fly off from the weld.

- Wear an approved welding helmet fitted with a proper shade of filter lenses to protect your face and eyes from arc rays and sparks when welding or watching (see ANSI Z49.1 and Z87.1 listed in Safety Standards).
- Wear approved safety glasses with side shields under your helmet.
- Use protective screens or barriers to protect others from flash, glare and sparks; warn others not to watch the arc.
- Wear protective clothing made from durable, flame-resistant material (leather, heavy cotton, or wool) and foot protection.



WELDING can cause fire or explosion.

Welding on closed containers, such as tanks, drums, or pipes, can cause them to blow up. Sparks can fly off from the welding arc. The flying sparks, hot workpiece, and hot equipment can cause fires and burns. Accidental contact of electrode to metal objects can cause sparks, explosion, overheating, or fire. Check and be sure the area is safe before doing any welding.

- Remove all flammables within 35 ft (10.7 m) of the welding arc. If this is not possible, tightly cover them with approved covers.
- Do not weld where flying sparks can strike flammable material.
- Protect yourself and others from flying sparks and hot metal.
- Be alert that welding sparks and hot materials from welding can easily go through small cracks and openings to adjacent areas.
- Watch for fire, and keep a fire extinguisher nearby.
- Be aware that welding on a ceiling, floor, bulkhead, or partition can cause fire on the hidden side.
- Do not weld on containers that have held combustibles, or on closed containers such as tanks, drums, or pipes unless they are properly prepared according to AWS F4.1 and AWS A6.0 (see Safety Standards).
- Do not weld where the atmosphere may contain flammable dust, gas, or liquid vapors (such as gasoline).
- Connect work cable to the work as close to the welding area as practical to prevent welding current from traveling long, possibly unknown paths and causing electric shock, sparks, and fire hazards.
- Do not use welder to thaw frozen pipes.

- Remove stick electrode from holder or cut off welding wire at contact tip when not in use.
- Wear oil-free protective garments such as leather gloves, heavy shirt, cuffless trousers, high shoes, and a cap.
- Remove any combustibles, such as a butane lighter or matches, from your person before doing any welding.
- After completion of work, inspect area to ensure it is free of sparks, glowing embers, and flames.
- Use only correct fuses or circuit breakers. Do not oversize or bypass them.
- Follow requirements in OSHA 1910.252 (a) (2) (iv) and NFPA 51B for hot work and have a fire watcher and extinguisher nearby.

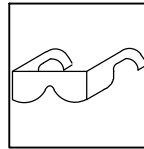

FLYING METAL or DIRT can injure eyes.

- Welding, chipping, wire brushing, and grinding cause sparks and flying metal. As welds cool, they can throw off slag.
- Wear approved safety glasses with side shields even under your welding helmet.



BUILDUP OF GAS can injure or kill.

- Shut off compressed gas supply when not in use.
- Always ventilate confined spaces or use approved air-supplied respirator.

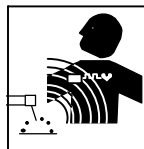

ELECTRIC AND MAGNETIC FIELDS (EMF) can affect Implanted Medical Devices.

- Wearers of Pacemakers and other Implanted Medical Devices should keep away.
- Implanted Medical Device wearers should consult their doctor and the device manufacturer before going near arc welding, spot welding, gouging, plasma arc cutting, or induction heating operations.



NOISE can damage hearing.

Noise from some processes or equipment can damage hearing.

- Wear approved ear protection if noise level is high.

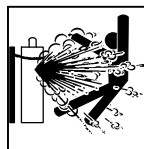

CYLINDERS can explode if damaged.

Compressed gas cylinders contain gas under high pressure. If damaged, a cylinder can explode. Since gas cylinders are normally part of the welding process, be sure to treat them carefully.

- Protect compressed gas cylinders from excessive heat, mechanical shocks, physical damage, slag, open flames, sparks, and arcs.
- Install cylinders in an upright position by securing to a stationary support or cylinder rack to prevent falling or tipping.
- Keep cylinders away from any welding or other electrical circuits.
- Never drape a welding torch over a gas cylinder.
- Never allow a welding electrode to touch any cylinder.
- Never weld on a pressurized cylinder – explosion will result.
- Use only correct compressed gas cylinders, regulators, hoses, and fittings designed for the specific application; maintain them and associated parts in good condition.
- Turn face away from valve outlet when opening cylinder valve.
- Keep protective cap in place over valve except when cylinder is in use or connected for use.
- Use the right equipment, correct procedures, and sufficient number of persons to lift and move cylinders.
- Read and follow instructions on compressed gas cylinders, associated equipment, and Compressed Gas Association (CGA) publication P-1 listed in Safety Standards.

1-3. Additional Symbols For Installation, Operation, And Maintenance



FIRE OR EXPLOSION hazard.

- Do not install or place unit on, over, or near combustible surfaces.
- Do not install unit near flammables.
- Do not overload building wiring – be sure power supply system is properly sized, rated, and protected to handle this unit.



FALLING EQUIPMENT can injure.

- Use lifting eye to lift unit only, NOT running gear, gas cylinders, or any other accessories.
- Use equipment of adequate capacity to lift and support unit.
- If using lift forks to move unit, be sure forks are long enough to extend beyond opposite side of unit.
- Keep equipment (cables and cords) away from moving vehicles when working from an aerial location.
- Follow the guidelines in the Applications Manual for the Revised NIOSH Lifting Equation (Publication No. 94-110) when manually lifting heavy parts or equipment.

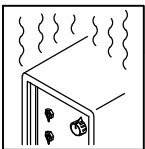

OVERUSE can cause OVERHEATING

- Allow cooling period; follow rated duty cycle.
- Reduce current or reduce duty cycle before starting to weld again.
- Do not block or filter airflow to unit.

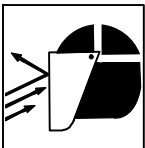

FLYING SPARKS can injure.

- Wear a face shield to protect eyes and face.
- Shape tungsten electrode only on grinder with proper guards in a safe location wearing proper face, hand, and body protection.
- Sparks can cause fires — keep flammables away.

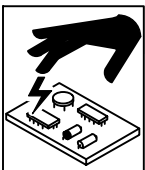

STATIC (ESD) can damage PC boards.

- Put on grounded wrist strap BEFORE handling boards or parts.
- Use proper static-proof bags and boxes to store, move, or ship PC boards.



MOVING PARTS can injure.

- Keep away from moving parts.
- Keep away from pinch points such as drive rolls.



WELDING WIRE can injure.

- Do not press gun trigger until instructed to do so.
- Do not point gun toward any part of the body, other people, or any metal when threading welding wire.

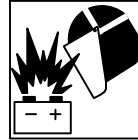

BATTERY EXPLOSION can injure.

- Do not use welder to charge batteries or jump start vehicles unless it has a battery charging feature designed for this purpose.



MOVING PARTS can injure.

- Keep away from moving parts such as fans.
- Keep all doors, panels, covers, and guards closed and securely in place.
- Have only qualified persons remove doors, panels, covers, or guards for maintenance and troubleshooting as necessary.
- Reinstall doors, panels, covers, or guards when maintenance is finished and before reconnecting input power.

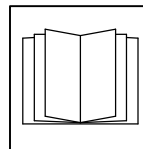

READ INSTRUCTIONS.

- Read and follow all labels and the Owner's Manual carefully before installing, operating, or servicing unit. Read the safety information at the beginning of the manual and in each section.
- Use only genuine replacement parts from the manufacturer.
- Perform maintenance and service according to the Owner's Manuals, industry standards, and national, state, and local codes.

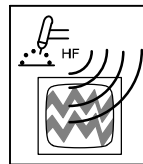

H.F. RADIATION can cause interference.

- High-frequency (H.F.) can interfere with radio navigation, safety services, computers, and communications equipment.
- Have only qualified persons familiar with electronic equipment perform this installation.
- The user is responsible for having a qualified electrician promptly correct any interference problem resulting from the installation.
- If notified by the FCC about interference, stop using the equipment at once.
- Have the installation regularly checked and maintained.
- Keep high-frequency source doors and panels tightly shut, keep spark gaps at correct setting, and use grounding and shielding to minimize the possibility of interference.

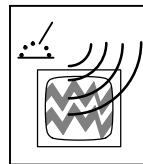

ARC WELDING can cause interference.

- Electromagnetic energy can interfere with sensitive electronic equipment such as computers and computer-driven equipment such as robots.
- Be sure all equipment in the welding area is electromagnetically compatible.
- To reduce possible interference, keep weld cables as short as possible, close together, and down low, such as on the floor.
- Locate welding operation 100 meters from any sensitive electronic equipment.
- Be sure this welding machine is installed and grounded according to this manual.
- If interference still occurs, the user must take extra measures such as moving the welding machine, using shielded cables, using line filters, or shielding the work area.

1-4. California Proposition 65 Warnings

 **Welding or cutting equipment produces fumes or gases which contain chemicals known to the State of California to cause birth defects and, in some cases, cancer. (California Health & Safety Code Section 25249.5 et seq.)**

 **This product contains chemicals, including lead, known to the state of California to cause cancer, birth defects, or other reproductive harm. Wash hands after use.**

1-5. Principal Safety Standards

Safety in Welding, Cutting, and Allied Processes, ANSI Standard Z49.1, is available as a free download from the American Welding Society at <http://www.aws.org> or purchased from Global Engineering Documents (phone: 1-877-413-5184, website: www.global.ihs.com).

Safe Practices for the Preparation of Containers and Piping for Welding and Cutting, American Welding Society Standard AWS F4.1, from Global Engineering Documents (phone: 1-877-413-5184, website: www.global.ihs.com).

Safe Practices for Welding and Cutting Containers that have Held Combustibles, American Welding Society Standard AWS A6.0, from Global Engineering Documents (phone: 1-877-413-5184, website: www.global.ihs.com).

National Electrical Code, NFPA Standard 70, from National Fire Protection Association, Quincy, MA 02269 (phone: 1-800-344-3555, website: www.nfpa.org and www.sparky.org).

Safe Handling of Compressed Gases in Cylinders, CGA Pamphlet P-1, from Compressed Gas Association, 14501 George Carter Way, Suite 103, Chantilly, VA 20151 (phone: 703-788-2700, website: www.cganet.com).

Safety in Welding, Cutting, and Allied Processes, CSA Standard W117.2, from Canadian Standards Association, Standards Sales, 5060

Spectrum Way, Suite 100, Ontario, Canada L4W 5N5 (phone: 800-463-6727, website: www.csa-international.org).

Safe Practice For Occupational And Educational Eye And Face Protection, ANSI Standard Z87.1, from American National Standards Institute, 25 West 43rd Street, New York, NY 10036 (phone: 212-642-4900, website: www.ansi.org).

Standard for Fire Prevention During Welding, Cutting, and Other Hot Work, NFPA Standard 51B, from National Fire Protection Association, Quincy, MA 02269 (phone: 1-800-344-3555, website: www.nfpa.org).

OSHA, Occupational Safety and Health Standards for General Industry, Title 29, Code of Federal Regulations (CFR), Part 1910, Subpart Q, and Part 1926, Subpart J, from U.S. Government Printing Office, Superintendent of Documents, P.O. Box 371954, Pittsburgh, PA 15250-7954 (phone: 1-866-512-1800) (there are 10 OSHA Regional Offices—phone for Region 5, Chicago, is 312-353-2220, website: www.osha.gov).

Applications Manual for the Revised NIOSH Lifting Equation, The National Institute for Occupational Safety and Health (NIOSH), 1600 Clifton Rd, Atlanta, GA 30333 (phone: 1-800-232-4636, website: www.cdc.gov/NIOSH).

1-6. EMF Information

Electric current flowing through any conductor causes localized electric and magnetic fields (EMF). Welding current creates an EMF field around the welding circuit and welding equipment. EMF fields may interfere with some medical implants, e.g. pacemakers. Protective measures for persons wearing medical implants have to be taken. For example, restrict access for passers-by or conduct individual risk assessment for welders. All welders should use the following procedures in order to minimize exposure to EMF fields from the welding circuit:

1. Keep cables close together by twisting or taping them, or using a cable cover.
2. Do not place your body between welding cables. Arrange cables to one side and away from the operator.
3. Do not coil or drape cables around your body.

4. Keep head and trunk as far away from the equipment in the welding circuit as possible.
5. Connect work clamp to workpiece as close to the weld as possible.
6. Do not work next to, sit or lean on the welding power source.
7. Do not weld whilst carrying the welding power source or wire feeder.

About Implanted Medical Devices:

Implanted Medical Device wearers should consult their doctor and the device manufacturer before performing or going near arc welding, spot welding, gouging, plasma arc cutting, or induction heating operations. If cleared by your doctor, then following the above procedures is recommended.

SECTION 2 – DEFINITIONS

Warning! Watch Out! There are possible hazards as shown by the symbols.

1 Electric shock can kill.

1.1 Wear dry insulating gloves. Do not touch electrode with bare hand. Do not wear wet or damaged gloves.

1.2 Protect yourself from electric shock by insulating yourself from work and ground.

1.3 Disconnect input plug or power before working on machine.

2 Breathing welding fumes can be hazardous to your health.

2.1 Keep your head out of the fumes.

2.2 Use forced ventilation or local exhaust to remove the fumes.

2.3 Use ventilating fan to remove fumes.

3 Welding sparks can cause explosion or fire.

3.1 Keep flammables away from welding. Do not weld near flammables.

3.2 Welding sparks can cause fires. Have a fire extinguisher nearby, and have a watchperson ready to use it.

3.3 Do not weld on drums or any closed containers.

4 Arc rays can burn eyes and injure skin.

4.1 Wear hat and safety glasses. Use ear protection and button shirt collar. Use welding helmet with correct shade of filter. Wear complete body protection.

5 Become trained and read the instructions before working on the machine or welding.

6 Do not remove or paint over (cover) the label.

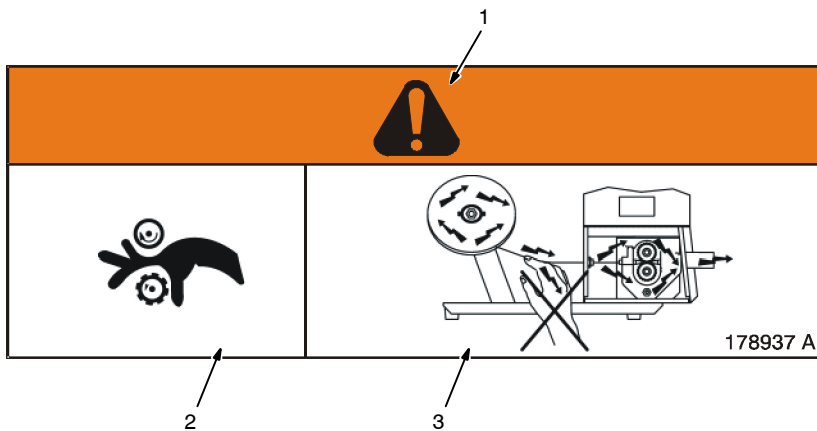
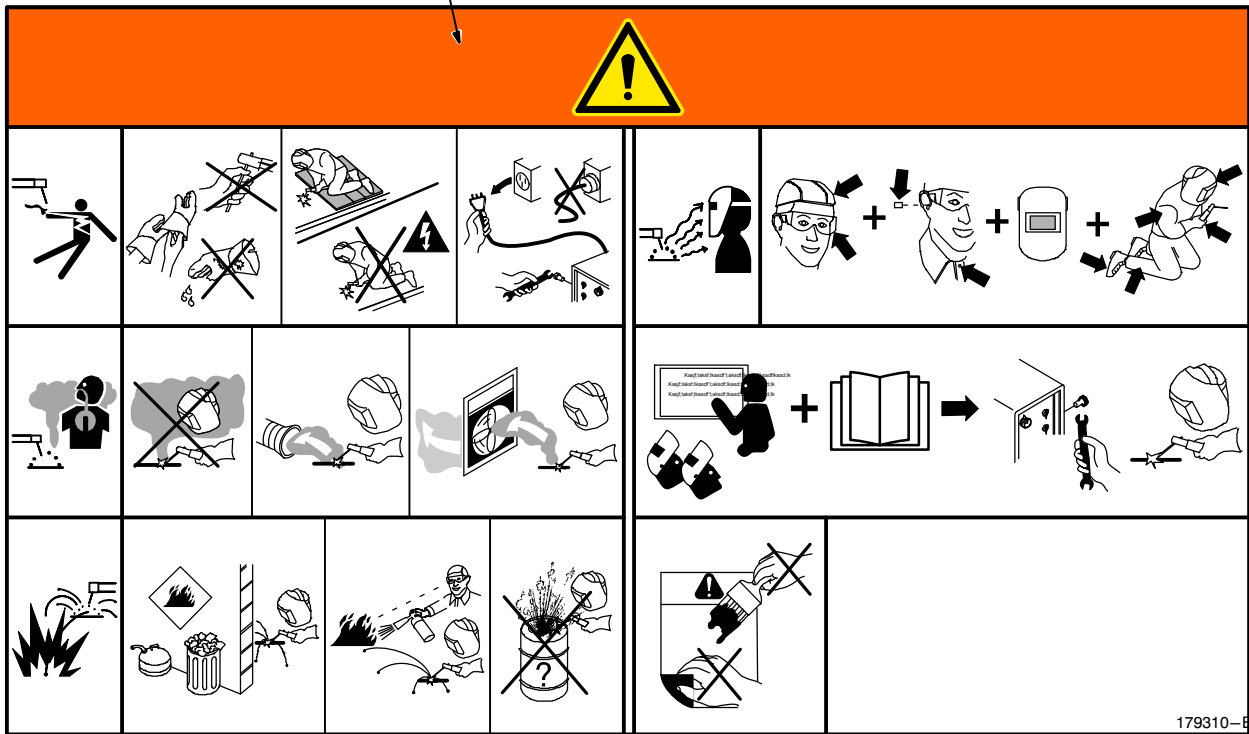

1 Warning! Watch Out! There are possible hazards as shown by the symbols.

2 Drive rolls can injure fingers

3 Welding wire and drive parts are at welding voltage during operation – keep hands and metal objects away.

Warning! Watch Out! There are possible hazards as shown by the symbols.

Electric shock from wiring can kill.

Disconnect input plug or power before working on machine.

Read the Owner's Manual before working on this machine.

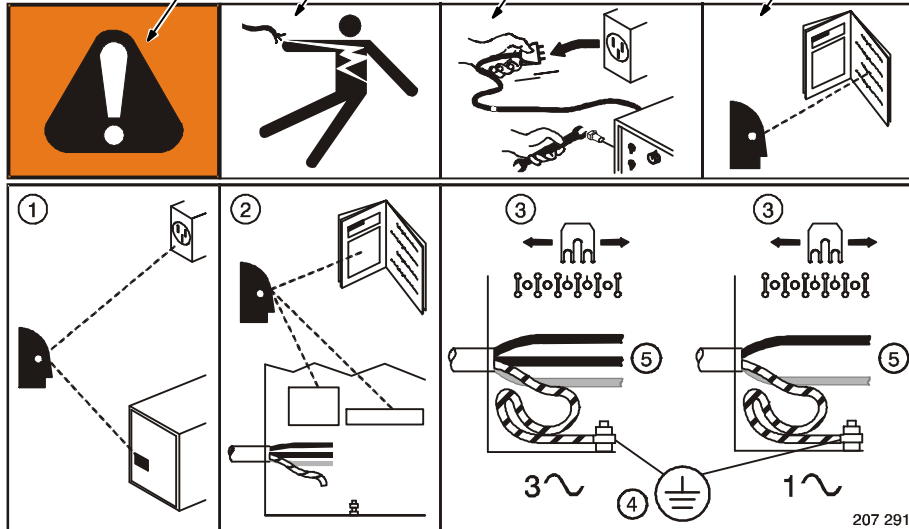

- 1 Consult rating label for input power requirements, and check power available at the job site – they must match.
- 2 Read Owner's Manual and inside labels for connection points and procedures.
- 3 Move jumper links as shown on inside label to match voltage at job site.
- 4 Having a loop of extra length, connect grounding conductor first.
- 5 Connect line input conductors as shown on inside label – double-check all connections, jumper link positions, and input voltage before applying power.

207 291

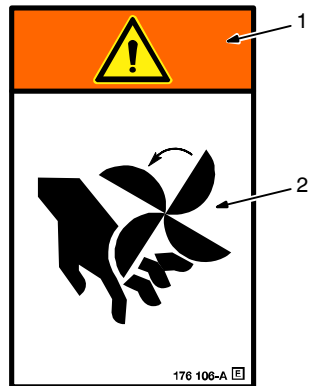

- 1 Warning! Watch Out! There are possible hazards as shown by the symbols.
- 2 Moving parts, such as fans, can cut fingers and hands and cause injury. Keep away from moving parts.

Warning! Watch Out! There are possible hazards as shown by the symbols.

Electric shock from wiring can kill.

Read the Owner's Manual before working on this machine.

Wear approved safety glasses.

- 1 Electrode Positive (Straight Polarity)
- 2 Electrode Negative (Reverse Polarity)

DCEP
Electrode Positive

DCEN
Electrode Negative

956.142.877-A

















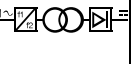

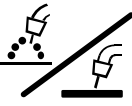
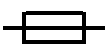



2-1. WEEE Label

Do not discard this product with general waste.

Reuse or recycle Waste Electrical and Electronic Equipment (WEEE) by disposing at a designated collection facility.

Contact your local recycling office or your local distributor for further information.

2-2. Symbols And Definitions

A	Amperes	V	Volts		Alternating Current (AC)		Direct Current (DC)
	Remote	I	On		Off		Protective Earth (Ground)
	Line Connection		Single Phase Static Frequency Converter-Transformer-Rectifier		Single Phase		Gas Metal Arc Welding (GMAW)
U₁	Primary Voltage	I_{1max}	Rated Maximum Supply Current	I_{1eff}	Maximum Effective Supply Current	U₂	Conventional Load Voltage
I₂	Rated Welding Current	X	Duty Cycle	%	Percent	U₀	Rated No Load Voltage (Average)
IP	Degree Of Protection		Fuse		Two-Step Trigger Operation		Four-Step Trigger Operation
	Gas Input		Gas Output		Voltage Input		Wire Feed
Hz	Hertz		Input		Program		Read Operator's Manual
	Wire Burnback Control		Diameter		Increase/Decrease		Variable Inductance

SECTION 3 – SPECIFICATIONS

3-1. Important Information Regarding CE Products (Sold Within The EU)

⚠ This equipment shall not be used by the general public as the EMF limits for the general public might be exceeded during welding.

This equipment is built in accordance with EN 60974–1 and is intended to be used only in an occupational environment (where the general public access is prohibited or regulated in such a way as to be similar to occupational use) by an expert or an instructed person.

Wire feeders and ancillary equipment (such as torches, liquid cooling systems and arc striking and stabilizing devices) as part of the welding circuit may not be a major contributor to the EMF. See the Owner's Manuals for all components of the welding circuit for additional EMF exposure information.

- The EMF assessment on this equipment was conducted at 0.5 meter.
- At a distance of 1 meter the EMF exposure values were less than 20% of the permissible values.

3-2. Information On Electromagnetic Compatibility (EMC)

⚠ This Class A equipment is not intended for use in residential locations where the electrical power is provided by the public low voltage supply system. There may be potential difficulties in ensuring electromagnetic compatibility in those locations, due to conducted as well as radiated disturbances.

⚠ This equipment does not comply with IEC 61000–3–12. If it is connected to a public low voltage system, it is the responsibility of the installer or user of the equipment to ensure, by consultation with the distribution network operator if necessary, that the equipment may be connected.

ce-emc 2 2010-10

3-3. Specifications

Model	Input Power Single Phase AC 50/60 Hz Voltage	Rated Output			Max. Open Circuit Voltage	Amperage/ Voltage Range DC	IP Rating	Dimension (mm)	Weight (kg)
		100%	60%	35%					
MPi 220P	230 Volts MIG	110 A 17.5 V	140 A 21.0 V	180 A 23.0 V	35 V	20 - 200 A 15.0 - 24.0 V	IP22S	L = 548 W = 237 H = 365	16
	230 Volts TIG	100 A 14.0 V	130 A 15.2 V	180 A 17.2 V	65 V	5 - 200 A 10.0 - 18.0 V			
	230 Volts STICK	100 A 24.0 V	130 A 25.2 V	170 A 26.8 V	65 V	5 - 200 A 20.2 - 28.0 V			

3-4. Duty Cycle And Overheating

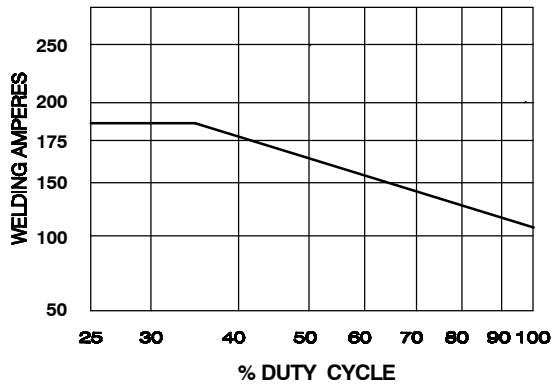

Duty Cycle is percentage of 10 minutes that unit can weld at rated load without overheating.

If unit overheats, thermostat(s) opens, output stops, and cooling fan runs. Wait fifteen minutes for unit to cool. Reduce amperage or duty cycle before welding.

NOTICE - Exceeding duty cycle can damage unit or gun and void warranty.

60% Duty Cycle At 140 Amperes

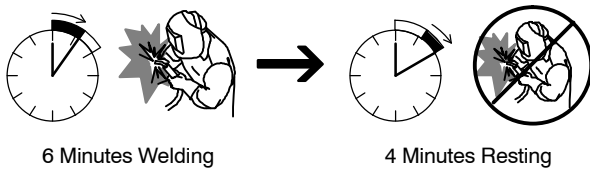

100% Duty Cycle At 110 Amperes

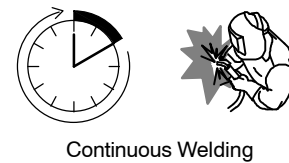

Overheating

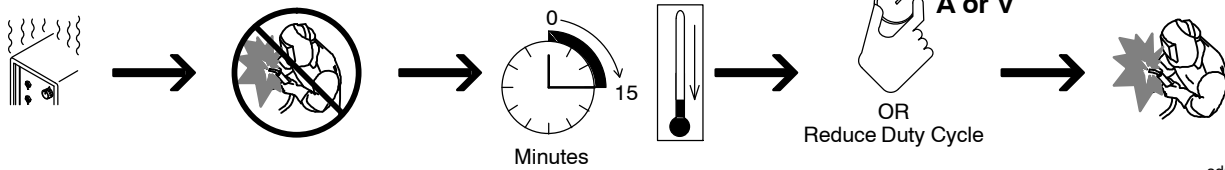

sduty1 5/95

3-5. Volt-Ampere Curves

The volt-ampere curves show the minimum and maximum voltage and amperage output capabilities of the welding power source. Curves of other settings fall between the curves shown.

A. MIG

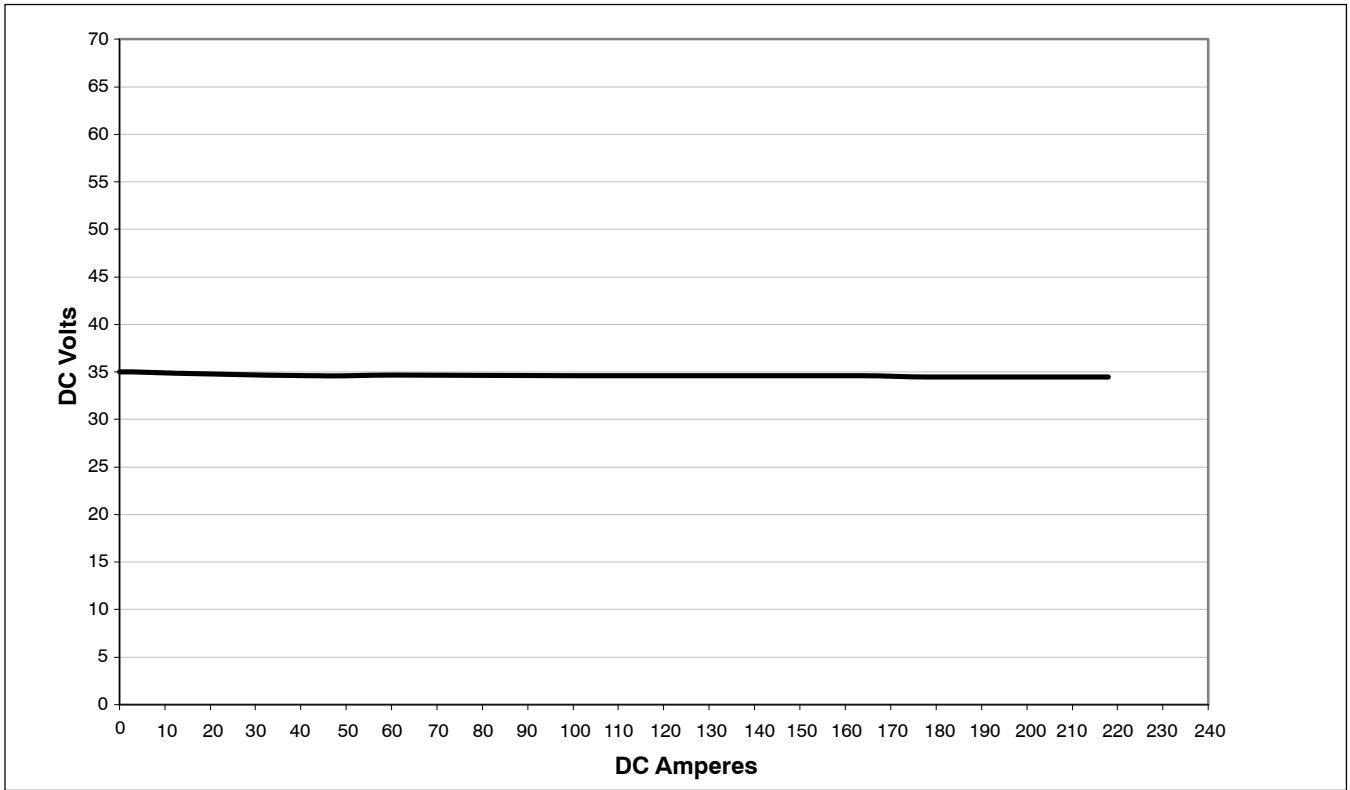

B. TIG/Stick

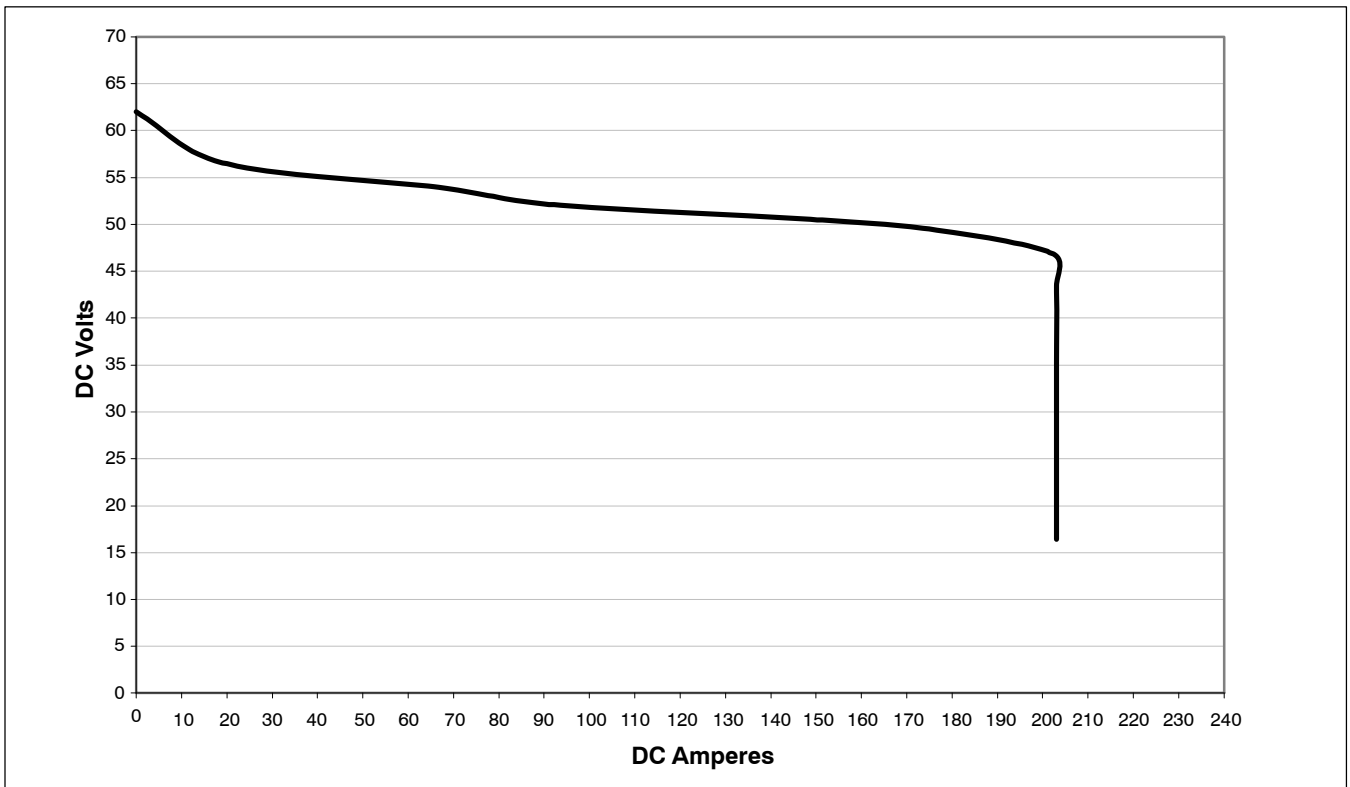

SECTION 4 – INSTALLATION

4-1. Serial Number And Rating Label Location

The serial number and rating information for this product is located on the bottom . Use rating label to determine input power requirements and/or rated output. For future reference, write serial number in space provided on back cover of this manual.

Operating Temperature Range: 14° F (-10° C) to 104° F (40° C). Rating were developed at an ambient temperature of 20° C to 25° C.

4-2. Selecting A Location



Airflow Distance Requirements

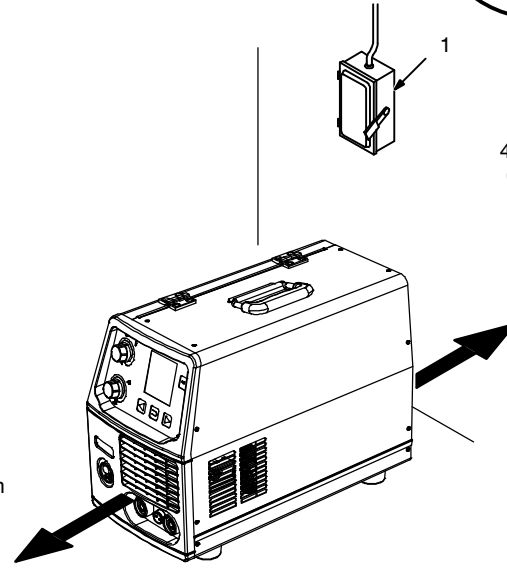

460 mm (18 in.)

460 mm (18 in.)

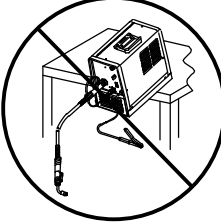

⚠ Do not move or operate unit where it could tip.

1 Line Disconnect Device

Locate unit near correct input power supply.

⚠ Special installation may be required where gasoline or volatile liquids are present – see NEC Article 511 or CEC Section 20.

Ref. 800 402-A / 956142881_4-A

4-3. Installing Gas Supply

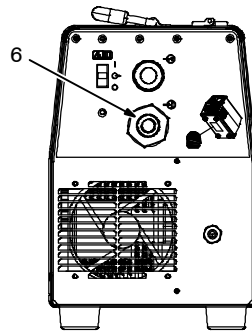
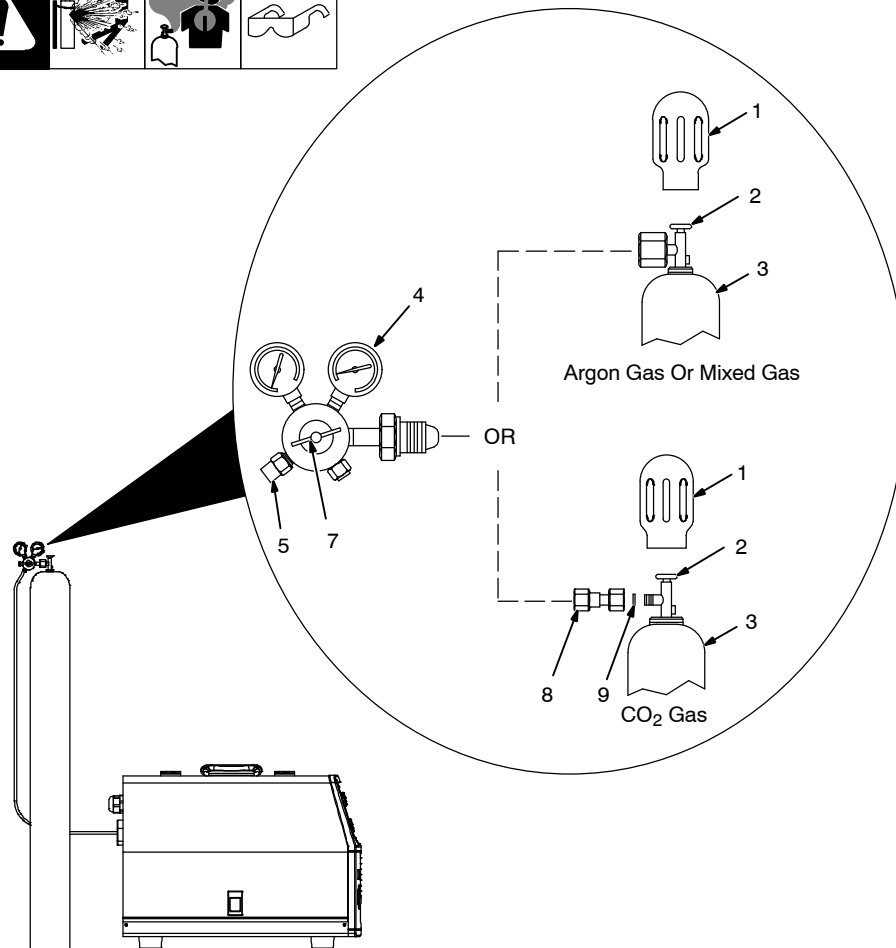

Rear Panel

Obtain gas cylinder and chain to running gear, wall, or other stationary support so cylinder cannot fall and break off valve.

- 1 Cap
- 2 Cylinder Valve

Remove cap, stand to side of valve, and open valve slightly. Gas flow blows dust and dirt from valve. Close valve.

- 3 Cylinder
- 4 Regulator/Flowmeter

Install so face is vertical.

- 5 Regulator/Flowmeter Gas Hose Connection

- 6 Welding Power Source Gas Hose Connection

Connect supplied gas hose between regulator/flowmeter gas hose connection, and fitting on rear of welding power source.

- 7 Flow Adjust

Typical flow rate is between 12-15 liters per minute. Check wire manufacturer's recommended flow rate.

- 8 CO₂ Adapter (Customer Supplied)

- 9 O-Ring (Customer Supplied)

Install adapter with O-ring between regulator/flowmeter and CO₂ cylinder.

4-4. Weld Output Terminals And Selecting Cable Sizes*

NOTICE – The Total Cable Length in Weld Circuit (see table below) is the combined length of both weld cables. For example, if the power source is 30 m (100 ft) from the workpiece, the total cable length in the weld circuit is 60 m (2 cables x 30 m). Use the 60 m (200 ft) column to determine cable size.

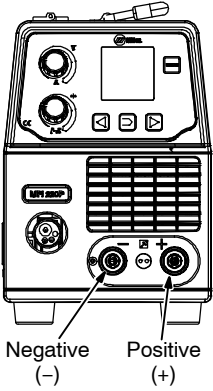
 <p>Weld Output Terminals</p> <p>⚠ Turn off power before connecting to weld output terminals.</p> <p>⚠ Do not use worn, damaged, undersized, or poorly spliced cables.</p>	Weld Cable Size** and Total Cable (Copper) Length in Weld Circuit Not Exceeding***									
	Welding Amperes	30 m (100 ft) or Less		45 m (150 ft)	60 m (200 ft)	70 m (250 ft)	90 m (300 ft)	105 m (350 ft)	120 m (400 ft)	
		10 – 60% Duty Cycle mm² (AWG)	60 – 100% Duty Cycle mm² (AWG)	10 – 100% Duty Cycle mm² (AWG)						
 <p>Negative (-) Positive (+)</p> <p>Ref. 956142881_-A</p>	100	20 (4)	20 (4)	20 (4)	30 (3)	35 (2)	50 (1)	60 (1/0)	60 (1/0)	
	150	30 (3)	30 (3)	35 (2)	50 (1)	60 (1/0)	70 (2/0)	95 (3/0)	95 (3/0)	
	200	30 (3)	35 (2)	50 (1)	60 (1/0)	70 (2/0)	95 (3/0)	120 (4/0)	120 (4/0)	
	250	35 (2)	50 (1)	60 (1/0)	70 (2/0)	95 (3/0)	120 (4/0)	2x70 (2x2/0)	2x70 (2x2/0)	
<p>* This chart is a general guideline and may not suit all applications. If cable overheats, use next size larger cable.</p> <p>**Weld cable size is based on either a 4 volts or less drop or a current density of at least 300 circular mils per ampere.</p> <p>***For distances longer than those shown in this guide, call a factory applications representative.</p> <p style="text-align: right;">Milan Ref. S-0007-J 2011-07</p>										

4-5. Process/Polarity Table

Process	Polarity	Cable Connections	
		Cable To Gun	Cable To Work
GMAW Solid wire with shielding gas	DCEP Reverse polarity	Connect to positive (+) output terminal	Connect to negative (-) output terminal
FCAW Self-shielding wire and no shielding gas	DCEN Straight polarity	Connect to negative (-) output terminal	Connect to positive (+) output terminal

4-6. Changing Polarity



- 1 Lead Connections For Direct Current Electrode Positive (DCEP)
- 2 Lead Connections For Direct Current Electrode Negative (DCEN)

Always read and follow wire manufacturer's recommended polarity and see Section 4-5.

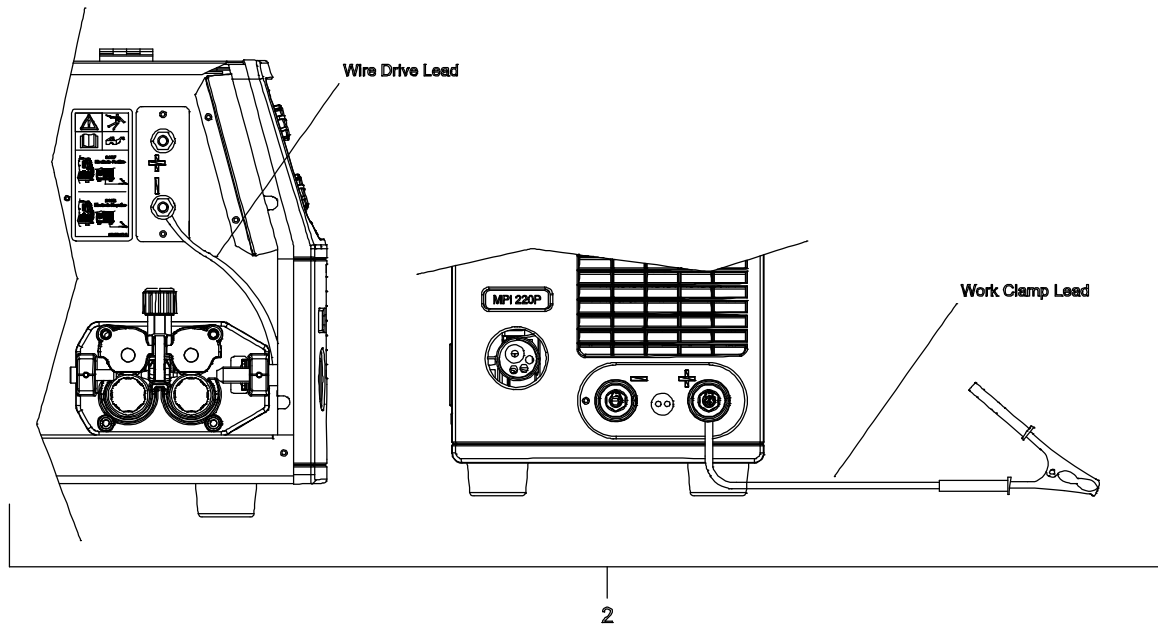
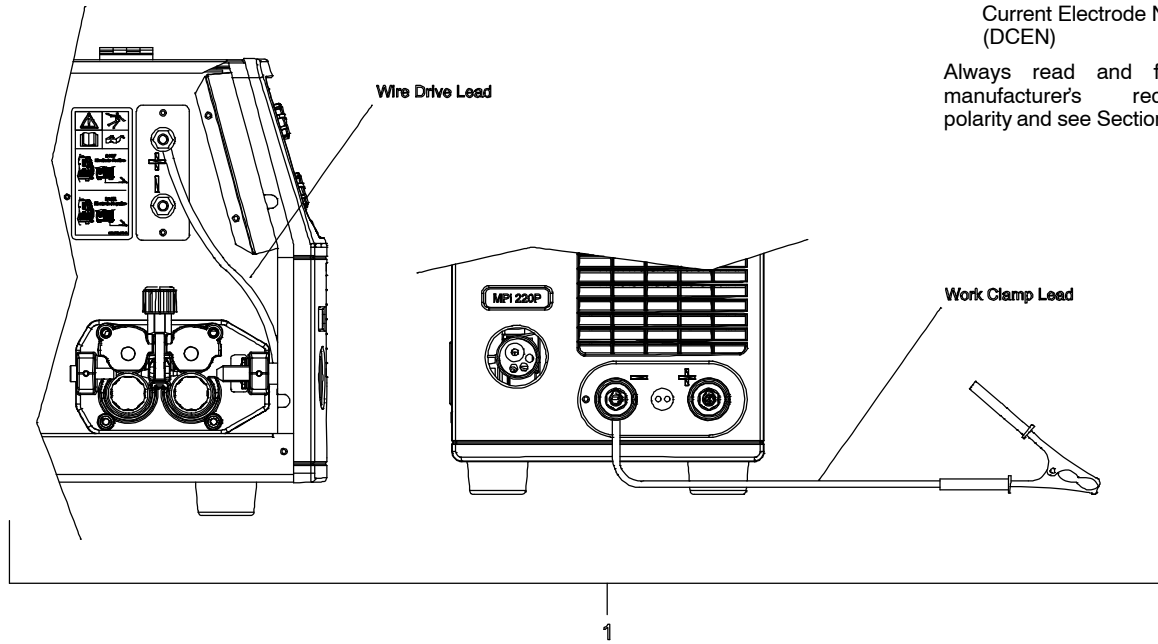

956142881_2-A

4-7. Installing Wire Spool And Adjusting Hub Tension



1 Wire Spool 5 kg

2 Handwheel

Allows adjustment of hub tension. Turn handwheel clockwise to increase tension.

3 Spool Holder Cap

Tighten to secure wire spool.

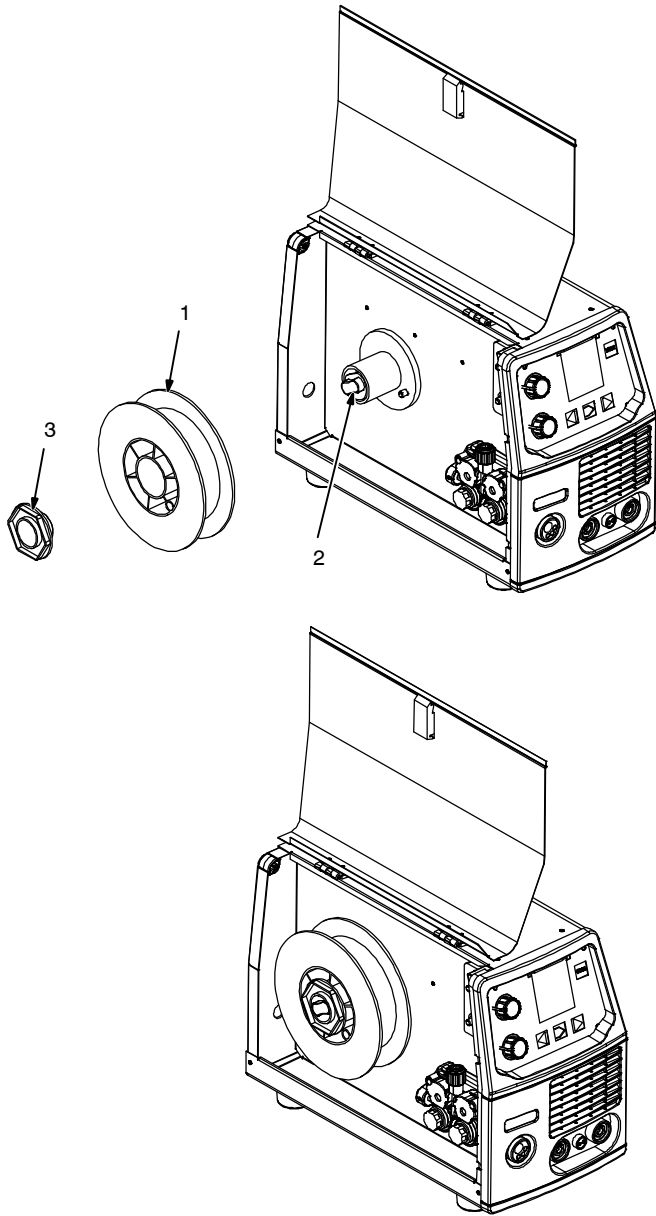

Tools Needed:



956142881_20-B

4-8. Changing Drive Rolls And Wire Inlet Guide

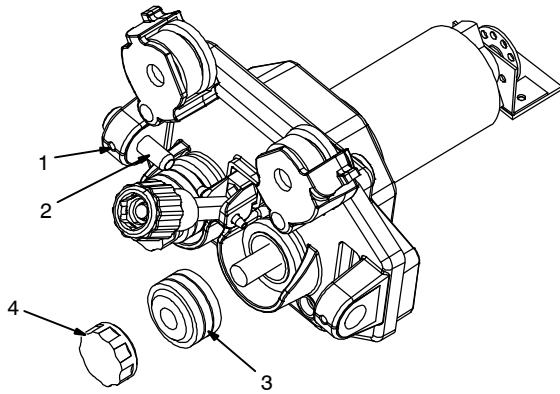
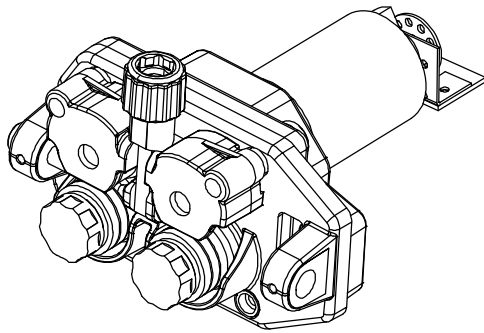

Tools Needed:

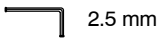

2.5 mm

- 1 Setscrew
- 2 Inlet Wire Guide

Loosen setscrew. Slide tip of guide as close to drive rolls as possible without touching. Tighten setscrew.

- 3 Drive Roll

The drive roll consists of two different sized grooves. The stamped markings on the end surface of the drive roll refers to the groove on the opposite side of the drive roll. The groove closest to the motor shaft is the proper groove to thread welding wire.

- 4 Drive Roll Securing Cap

Turn cap clockwise to secure drive roll.

956142881_19-A

4-9. Aligning Drive Rolls and Wire Guide

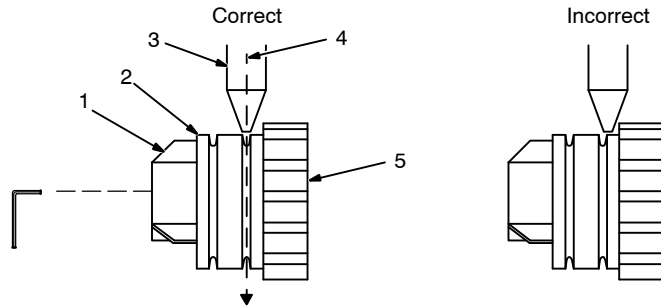

⚠ Turn off and disconnect input power

View is from top of drive rolls looking down with pressure assembly open.

- 1 Drive Roll Securing Nut
- 2 Drive Roll
- 3 Wire Guide
- 4 Welding Wire
- 5 Drive Gear

Insert screwdriver, and turn screw in or out until drive roll groove lines up with wire guide.

Close pressure roll assembly.

Tools Needed:

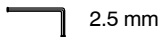

2.5 mm

Ref. 800 412-A

Notes

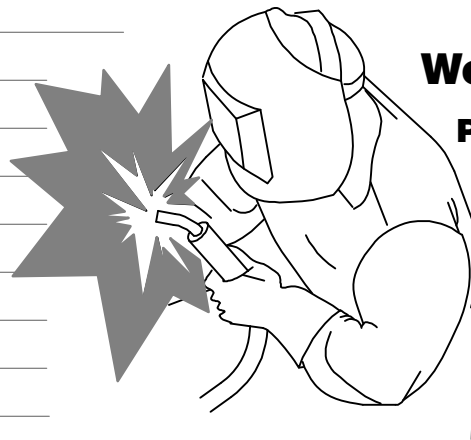

Work like a Pro!
Pros weld and cut safely. Read the safety rules at the beginning of this manual.

4-10. Electrical Service Guide



Failure to follow these electrical service guide recommendations could create an electric shock or fire hazard. These recommendations are for a dedicated branch circuit sized for the rated output and duty cycle of the welding power source.

	50/60 Hz Single Phase
Input Voltage (V)	230
Input Amperes (A) At Rated Output	37
Max Recommended Standard Fuse Rating In Amperes¹	
Time-Delay Fuses²	45
Normal Operating Fuses³	60
Min Input Conductor Size In AWG⁴	6 (10)
Max Recommended Input Conductor Length In Meters (Feet)	29 (95)
Min Grounding Conductor Size In AWG⁴	6 (10)

Reference: 2011 National Electrical Code (NEC) (including article 630)

1 If a circuit breaker is used in place of a fuse, choose a circuit breaker with time-current curves comparable to the recommended fuse.

2 "Time-Delay" fuses are UL class "RK5". See UL 248.

3 "Normal Operating" (general purpose - no intentional delay) fuses are UL class "K5" (up to and including 60 amps), and UL class "H" (65 amps and above).

4 Conductor data in this section specifies conductor size (excluding flexible cord or cable) between the panelboard and the equipment per NEC Table 310.15(B)(16). If a flexible cord or cable is used, minimum conductor size may increase. See NEC Table 400.5(A) for flexible cord and cable requirements.

4-11. Connecting 230 VAC Single Phase Input Power

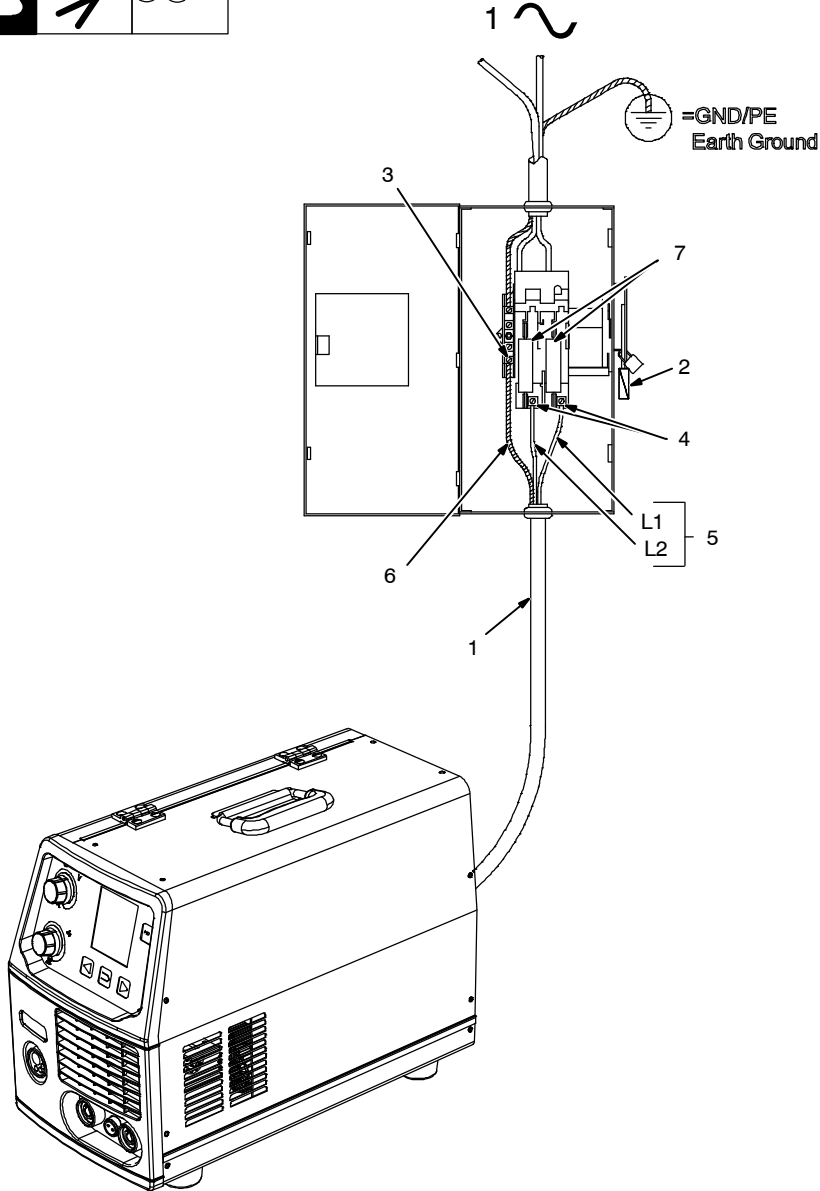

⚠ Installation must meet all National and Local Codes – have only qualified persons make this installation.

⚠ Disconnect and lockout/tagout input power before connecting input conductors from unit.

⚠ Always connect green or green/yellow conductor to supply grounding terminal first, and never to a line terminal.

See rating label on unit and check input voltage available at site.

- 1 Input Power Cord
- 2 Disconnect Device (switch shown in the OFF position)
- 3 Disconnect Device Grounding Terminal
- 4 Disconnect Device Line Terminals
- 5 Black And White Input Conductor (L1 And L2)
- 6 Green Or Green/Yellow Grounding Conductor

Connect green or green/yellow grounding conductor to disconnect device grounding terminal first.

Connect input conductors L1 and L2 to disconnect device line terminals.

7 Over-Current Protection

Select type and size of over-current protection using Section 4-10 (fused disconnect switch shown).

Close and secure door on disconnect device. Remove lockout/tagout device, and place switch in the On position.

Tools Needed:



956142881_5-A

4-12. Threading Welding Wire And Adjusting Pressure Roll Tension



- 1 Wire Spool
 - 2 Welding Wire
 - 3 Inlet Wire Guide
 - 4 Pressure Adjustment Knob
 - 5 Drive Roll
 - 6 Outlet Wire Guide
 - 7 Gun Conduit Cable
- Lay gun cable out straight.

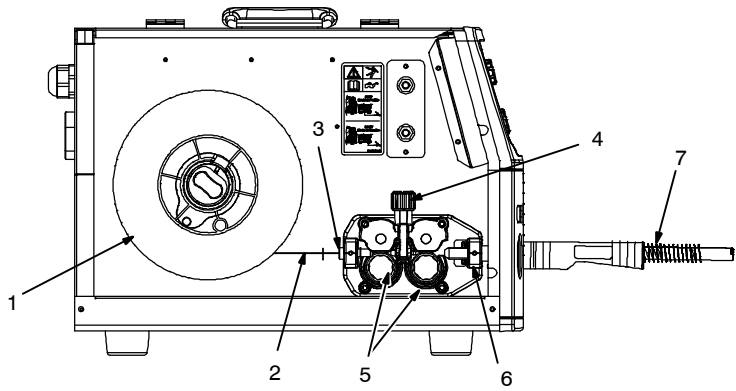

Tools Needed:

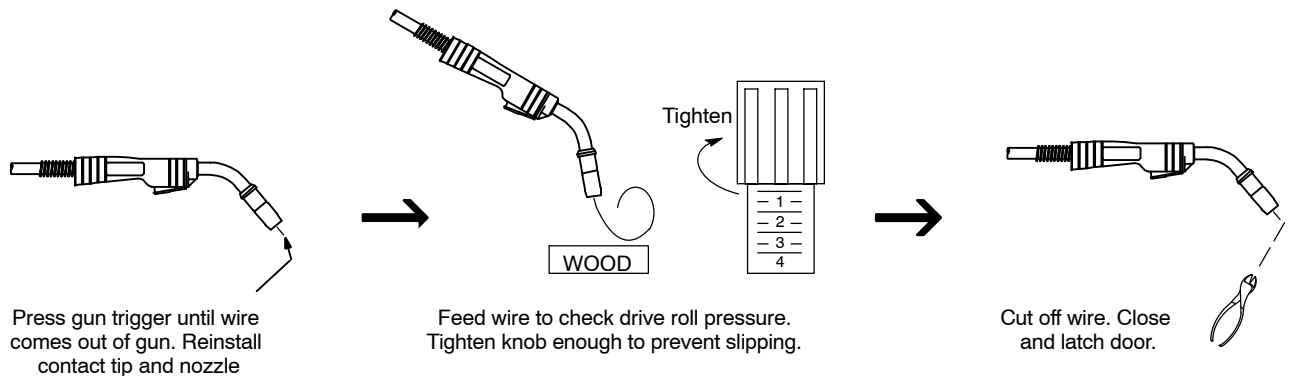
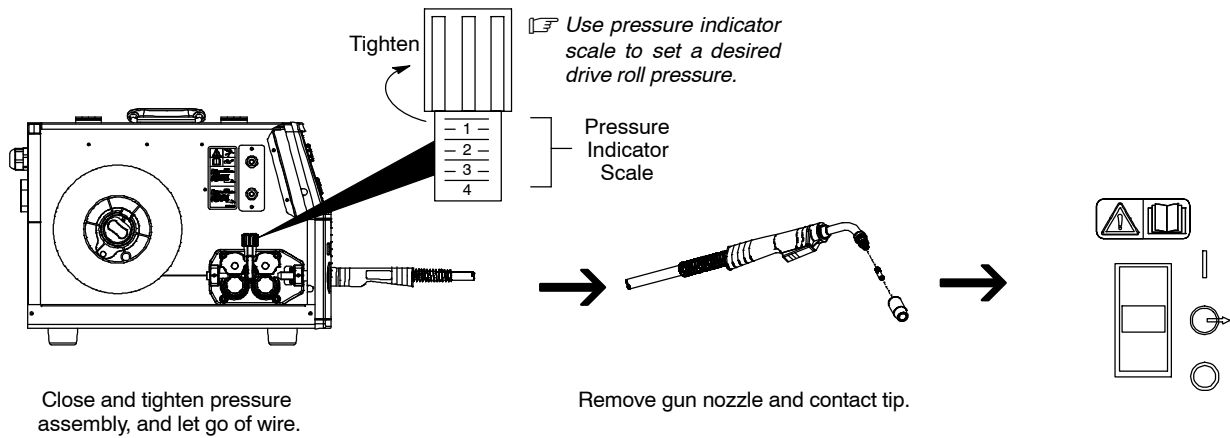
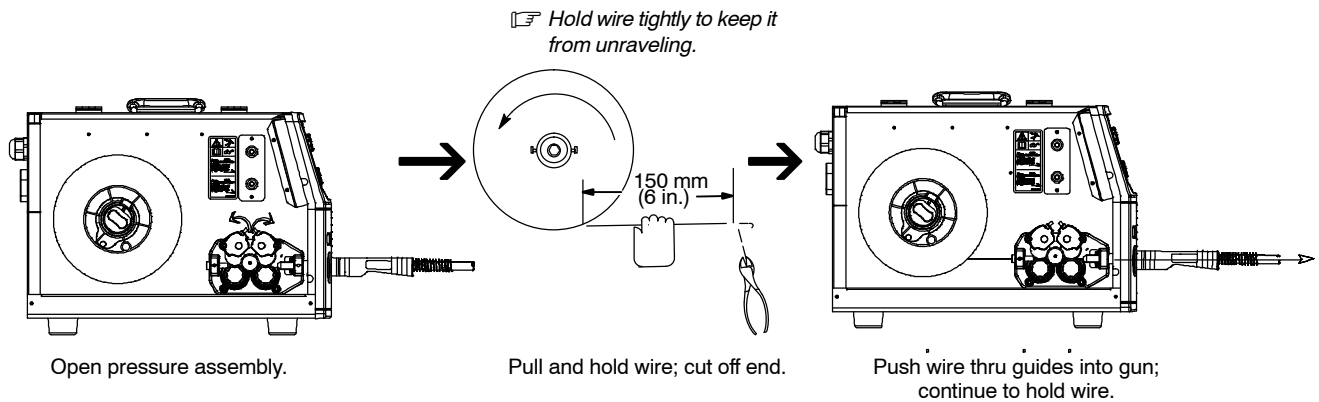
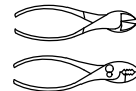

Ref. 956142881_3-A

SECTION 5 – OPERATION

5-1. Controls

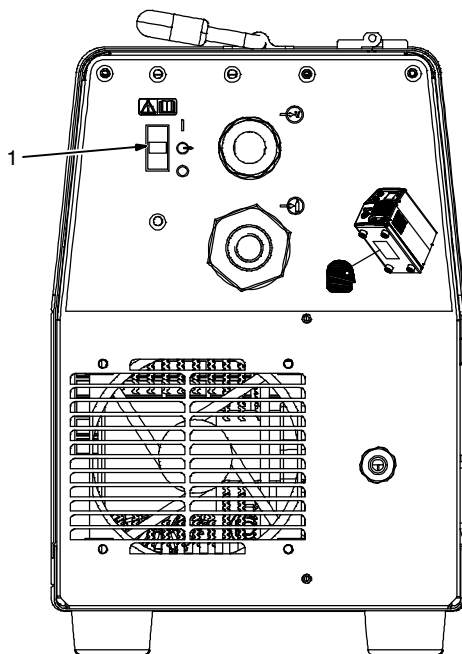
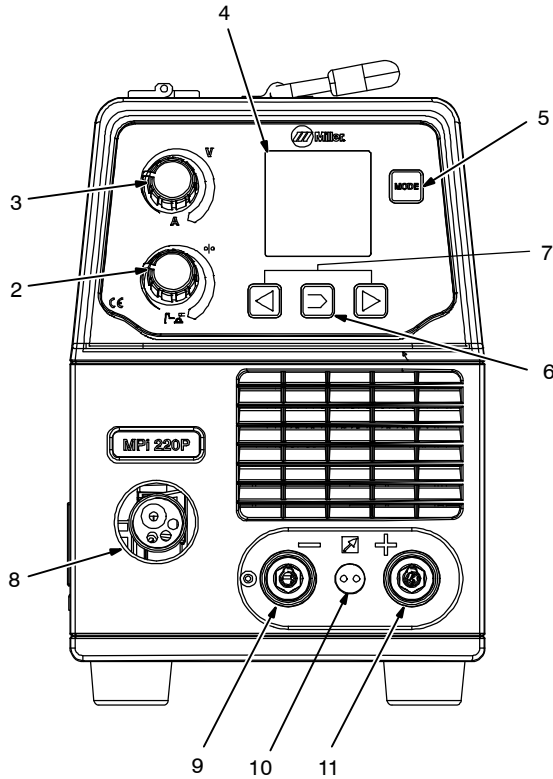
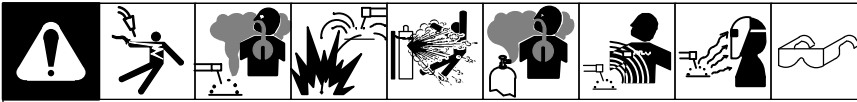

- 1 Power Switch S1
Use switch to turn power on and off.
- 2 Wire Speed/Set-Up Adjustment Control
Use control to adjust wire speed and change values while in the set-up mode.
- 3 Amperage/Workpiece Thickness Adjustment Control
Use control to adjust welding amperage while in TIG and STICK mode (see Section 5-2 or 5-3) or workpiece thickness while in MIG mode (see Section 5-5).
- 4 Digital Display Meter
Displays values and parameters for selected welding process.
- 5 Process Selector Switch
Use switch to select process, TIG, STICK or MIG.
- 6 Program/Sequencer Switch
Use switch to select programs and scroll through sequencer parameters while in MIG mode (see Section 5-5).
- 7 Sequencer Selector Switch
Use switch to scroll through sequencer parameter while in MIG mode.
- 8 MIG Torch Connection
Connection for Euro style MIG gun.
- 9 Negative Weld Output Receptacle
For Stick and MIG welding, connect work cable to this receptacle. For TIG welding, connect torch to this receptacle.
- 10 Gun Trigger Receptacle
- 11 Positive Weld Output Receptacle
For Stick welding, connect electrode cable to this receptacle. For TIG welding, connect work cable to this receptacle.

5-2. Preparing Unit For Stick Welding

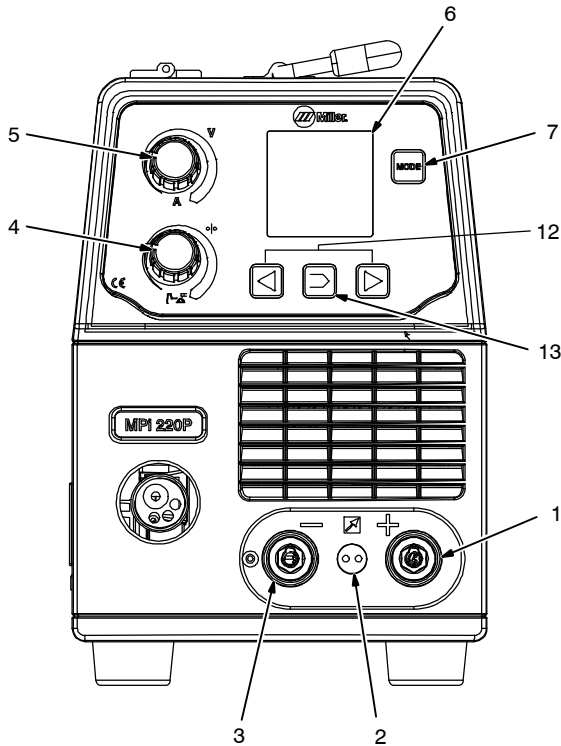
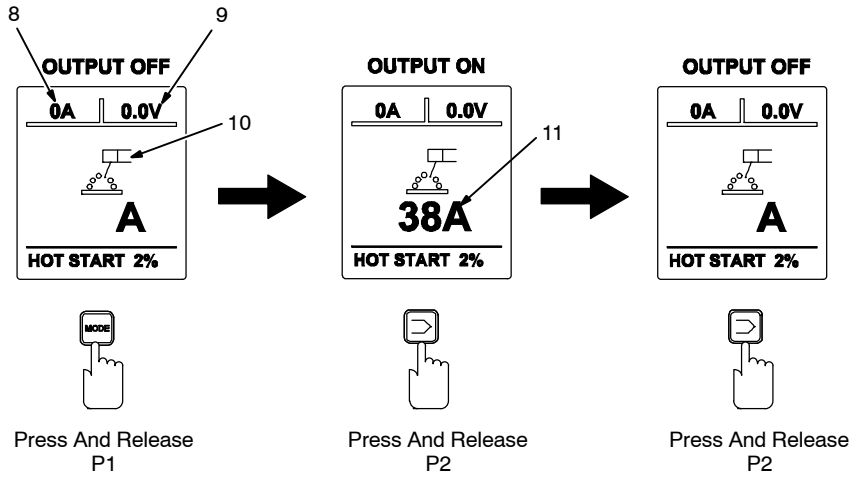
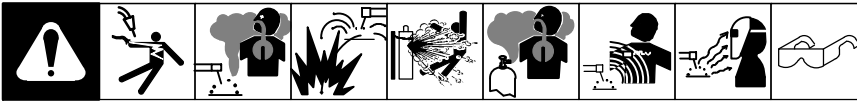

- 1 Positive Weld Output Terminal
- 2 Gun Trigger Receptacle
- 3 Negative Weld Output Terminal
- 4 Hot Start Adjustment Knob
- 5 Amperage Adjustment Control Knob
- 6 Digital Meter Display
- 7 Process Selector P1 Push Button
- 8 Welding Amperage
- 9 Welding Voltage
- 10 Stick Welding Symbol
- 11 Set Amperage (Output On)
- 12 Hot Start Adjustment Switch
- 13 Sequencer Set-Up P2 Push Button

Prepare unit for Stick welding as follows:

Connect electrode holder to positive weld output receptacle.

Connect work clamp to negative weld output terminal.

Turn power on. Allow time for unit to complete its start up cycle.

Press and release Process selector P1 push button to select Stick welding. Corresponding symbol is displayed.

While in Stick mode, the output is set to off. Output is turned on/off by pressing and releasing Sequencer set-up P2 push button.

When output is turned on, use amperage adjustment knob to set desired amperage value. Rotate knob clockwise to increase amperage (min - max).

Hot Start Setting

Use Hot Start to increase output amperage at the start of a weld to help prevent electrode sticking.

To change Hot Start setting, proceed as follows:

Use the Amperage Adjustment control knob or switch to change amperage from 0 to 50 percent of the preset amperage value, with 20 percent being the default value. The maximum Hot Start amperage value is 250 amperes.

Example: if preset amperage is 90 amperes, 0% = 90 amperes, 50% = 135 amperes.

5-3. Preparing Unit For TIG Welding

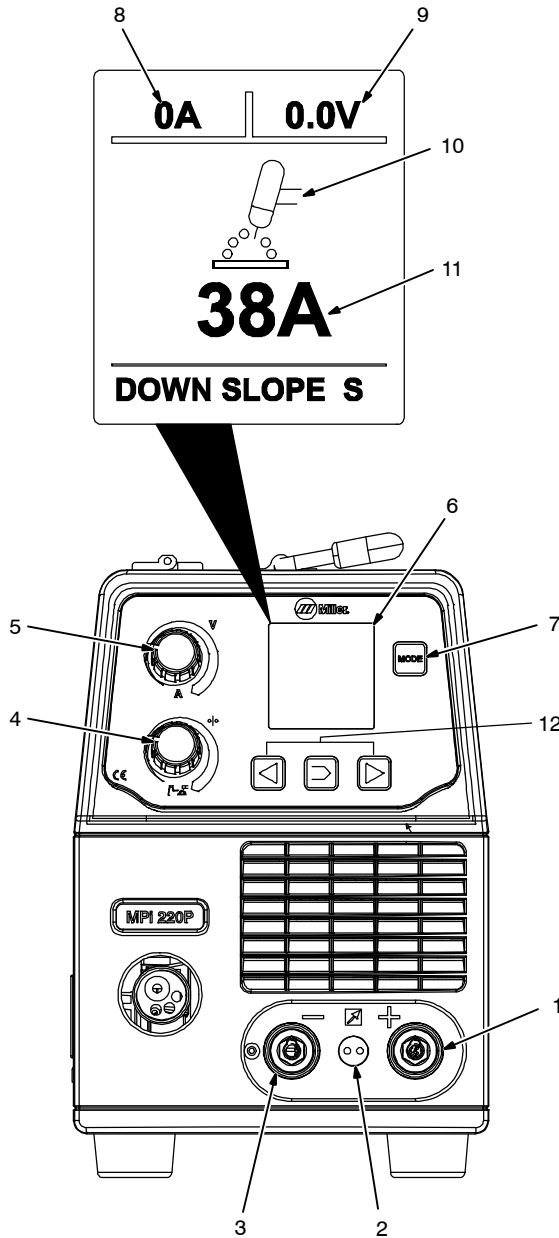
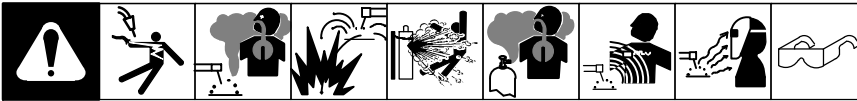

- 1 Positive Weld Output Terminal
- 2 Gun Trigger Receptacle
- 3 Negative Weld Output Terminal
- 4 Hot Start Adjustment Knob
- 5 Amperage Adjustment Control Knob
- 6 Digital Meter Display
- 7 Process Selector Switch
- 8 Welding Amperage
- 9 Welding Voltage
- 10 TIG Welding Symbol
- 11 Set Amperage
- 12 Hot Start Adjustment Switch

Prepare unit for TIG welding as follows:

Connect electrode holder to negative weld output receptacle.

Connect work clamp to positive weld output terminal.

Turn power on. Allow time for unit complete its start up cycle.

Press and release Process selector switch to select TIG welding. Corresponding symbol is displayed. Use amperage adjustment control knob to set desired amperage value. Rotate knob clockwise to increase amperage (min - max).

Slope Down Setting

To change Slope Down setting, proceed as follows:

Use the Amperage Adjustment control knob or switch to reduce amperage over a set period of time (0 - 20 seconds) at the end of the weld. The default setting is 2 seconds.

Application

Slope Down should be used while TIG welding materials that are crack sensitive, and/or the operator wants to eliminate the crater at the end of the weld.

5-4. 2T – 4T Trigger Mode Selection (TIG Process)

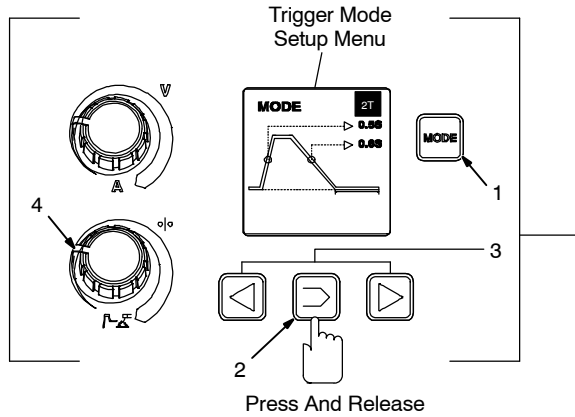
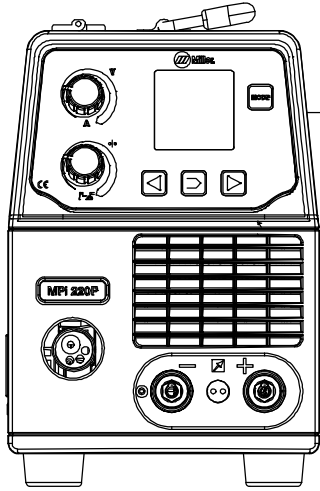
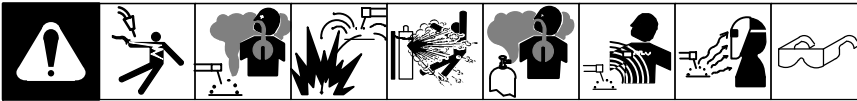

SCROLL THROUGH SEQUENCERS (2T And 4T Trigger Mode)

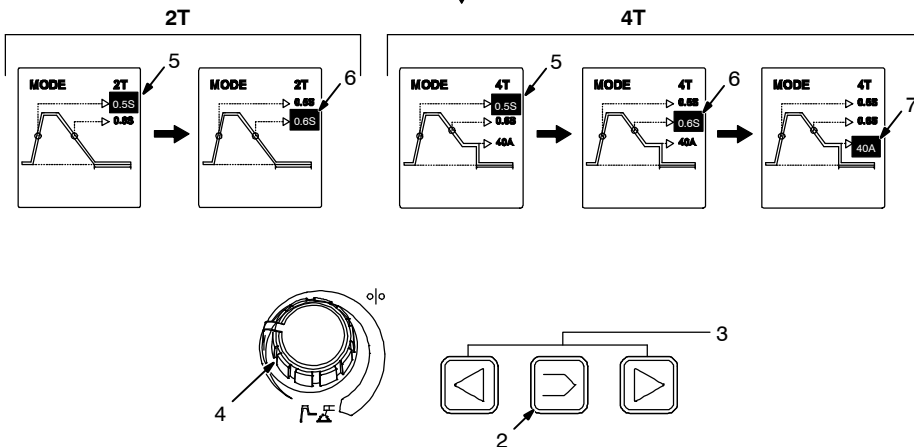

- 1 Process Selection P1 Push Button
- 2 Sequencer Set-Up P2 Push Button
- 3 Sequencer Adjustment P3 Push Buttons
- 4 Wire Feed Speed (WFS) Adjustment Knob

While in TIG mode, select desired trigger mode as follows:

Press and release P2 push button to enter in trigger mode set-up menu. Select desired trigger mode by using P3 push buttons or WFS adjustment knob.

5 Slope Up Time

Use control to select amount of time that it takes to slope up/down from initial amperage to weld amperage. To disable, set to 0. When this item is selected, use the Wire Feed Speed adjustment knob or Sequencer adjustment P3 push buttons to change value. Default = 2 seconds (min = 0 sec, max = 20.0 sec).

6 Slope Down Time

Use control to select amount of time that it takes to slope up/down from weld amperage to final amperage. To disable, set to 0. When this item is selected, use the Wire Feed Speed adjustment knob or Sequencer adjustment P3 push buttons to change value. Default = 2 seconds (min = 0 sec, max = 20.0 sec). Press P1 push button to save and exit from set-up menu.

Application

Slope Down time should be used while TIG welding materials that are crack sensitive, and/or the operator wants to eliminate the crater at the end of the weld.

7 Final Current

Use control to select amperage to which weld amperage will either slope up or down. When this item is selected, use the Wire Feed Speed adjustment knob or Sequencer adjustment P3 push button to change the value. Default = 20 amperes (min = 0A, max = 200A). Press P1 to save and exit from set-up menu.

5-5. Preparing Unit For Manual MIG (GMAW And FCAW) Welding Process

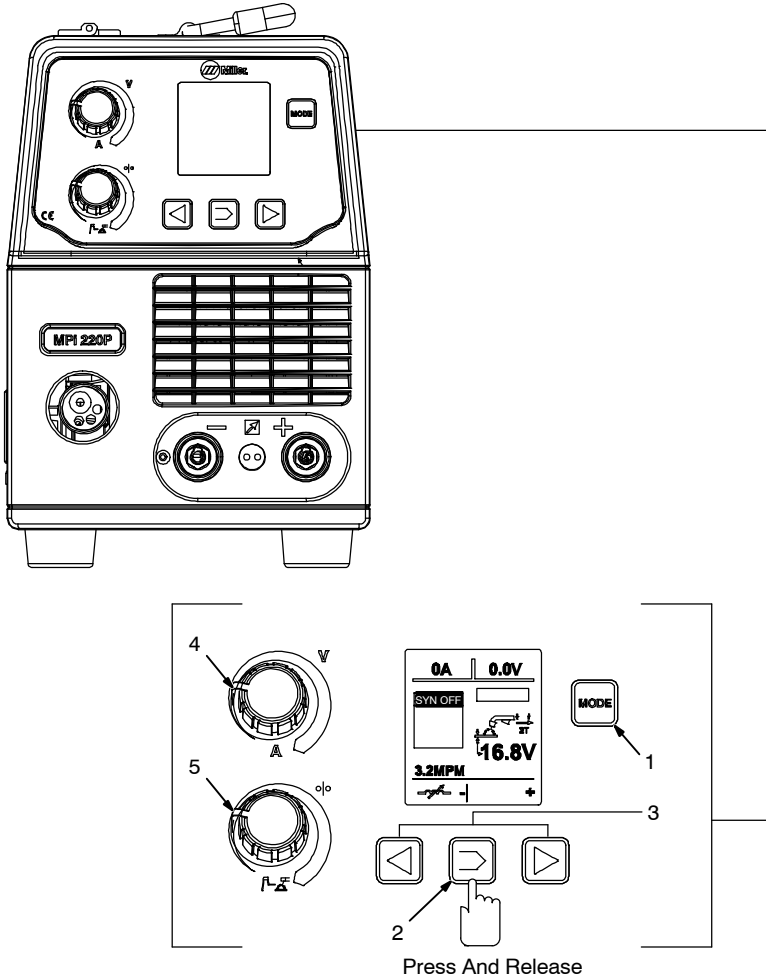
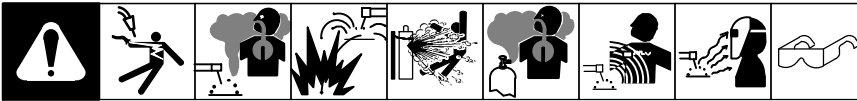

To select MIG welding proceed as follows:

Prepare unit according to Section 4.

Use a cable with correct adapter, connect gun to the MIG gun connector.

For GMAW process:

Connect wire drive lead to positive output terminal. Connect work clamp lead to negative output terminal. See Section 4-5 for GMAW solid wire with shielding gas process. See Section 4-3 for installing gas supply.

For FCAW process:

Connect wire drive lead to negative output terminal. Connect work clamp lead to positive output terminal. See Section 4-5 for FCAW self-shielding wire no shielding gas process.

- 1 Process Selection P1 Push Button
- 2 Sequencer Set-Up P2 Push Button
- 3 Sequencer Adjustment/Operator Point Setting P3 Push Buttons (See Section 5-16)
- 4 Welding Voltage Adjustment Knob

Use knob to select desired welding voltage. Rotate knob clockwise to increase the output voltage value (min = 10 volts DC, max = 35 volts DC).

- 5 Wire Feed Speed (WFS) Adjustment Knob

Use knob to select desired WFS. Rotate knob clockwise to increase WFS value (min = 0 mpm, max = 20.9 mpm).

Set MIG welding process using process selection P1 push button. To enter in manual MIG mode, press and release sequencer set-up P2 push button. Use sequencer adjustment P3 push buttons until SYN-OFF is displayed. Press and release P2 again to confirm selection.

In manual MIG mode, the operator may need to adjust main welding parameters for specific arc characteristics. Wire feed speed and arc voltage will appear on digital meter display.

Ref. 956142881_8-A

5-6. Manual MIG Welding Set-Up Menu

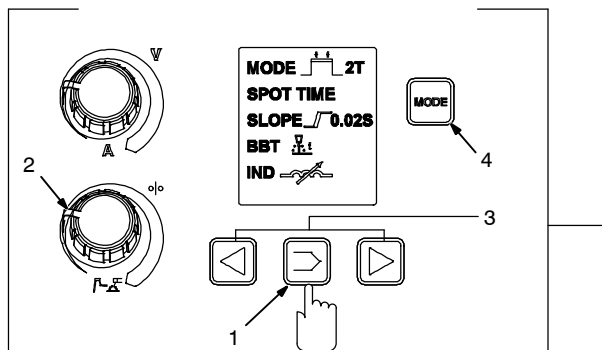
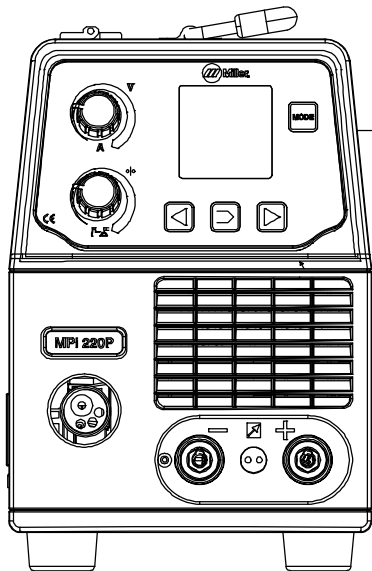
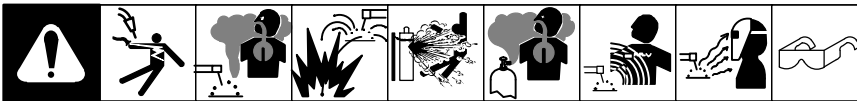

Press And Hold

SCROLL THROUGH SEQUENCERS

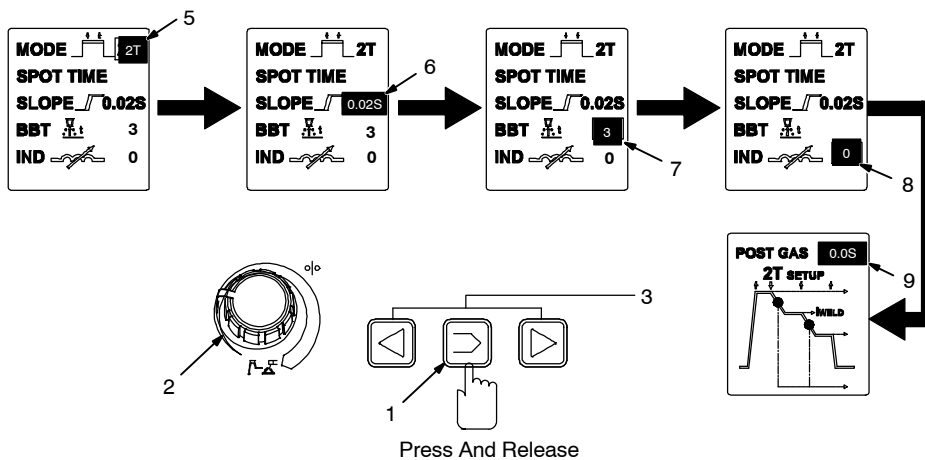

Press And Release

To enter MIG welding set-up menu, proceed as follows:

1 Sequencer Set-Up P2 Push Button

2 Wire Feed Speed (WFS) Adjustment Knob

While in the set-up menu, use knob to change sequencer parameters.

3 Sequencer Adjustment/Operator Point Setting P3 Push Buttons (See Section 5-16)

4 Process Selection P1 Push Button

Press and hold P2 push button to enter into the set-up menu. Sequencers will be displayed on the digital meter display. To change parameters, use P3 push buttons or Wire Feed Speed (WFS) adjustment knob. To scroll through sequencers, press and release P2 push button. To exit from set-up menu, press and release process selection P1 push button and desired parameters will be stored.

5 Trigger Mode (2T/4T)

Use the Wire Feed Speed adjustment knob or Sequencer adjustment P3 push buttons to change the value (see Section 5-7).

6 Slope Time

Use control to select amount of time that it takes to slope up/down from initial amperage to weld amperage. To disable, set to 0. When this item is selected, use the Wire Feed Speed adjustment knob or Sequencer adjustment P3 push buttons to change the value. Default = 0.2 seconds (min = 0 sec, max = 1.5 sec).

7 Burnback Time (BBT)

Time that welding wire stays energized after trigger is released. This is a predetermined value in MIG mode and cannot be changed.

8 Weld Output Inductance

Use control to select inductance value. When this is selected, use the Wire Feed Speed adjustment knob or Sequencer adjustment P3 push buttons to change value. Default = 0 (min = 0, max = 11). Low inductance is used for most short arc applications. High inductance is for stainless steel and spray arc applications.

5-6. Manual MIG Welding Set-Up Menu (Continued)

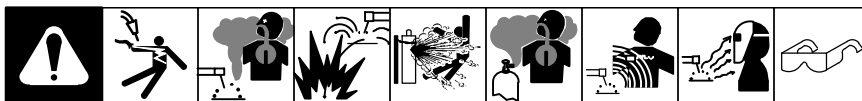

 In short circuit GMAW welding, an increase in inductance will decrease the number of short circuit transfers per second (provided no other changes are made) and increase the arc-on time. The increased arc-on time makes the welding puddle more fluid.

9 Postflow Time

Use control to set length of time gas flows after welding stops to protect the weld puddle. When this item is selected, use the Wire Feed Speed adjustment knob to change value. Default = 0.3 seconds (min = 0 sec, max = 3 sec).

5-7. Trigger Mode And Spot Time Selection (MIG Process)

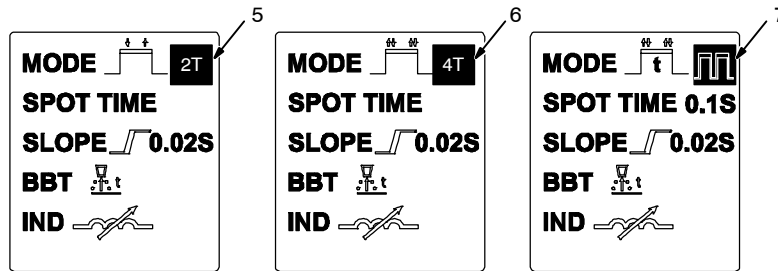
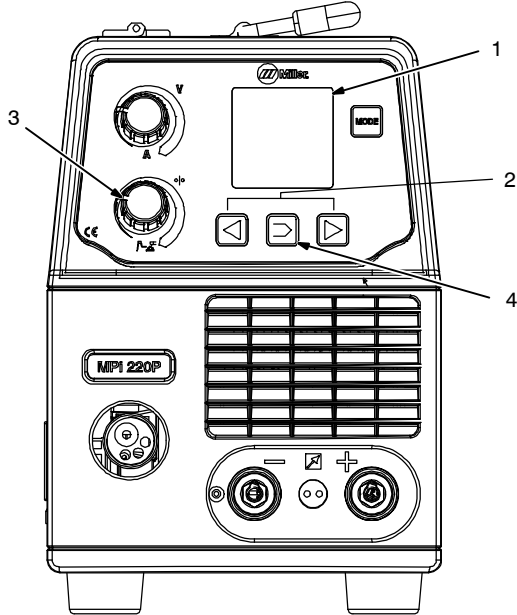
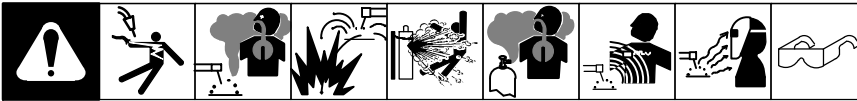

☞ Always select a trigger mode.

- 1 Digital Display Meter
- 2 Sequencer Set-Up P3 Push Buttons
- 3 Wire Feed Speed (WFS) Adjustment Knob
- 4 Sequencer Adjustment/Operator Point Setting P2 Push Button

To select trigger mode and spot weld timer, proceed as follows:

Press and hold P2 push button to enter into the set-up menu. Sequencers will be displayed on the digital meter display. To change parameters, use the P3 push buttons or Wire Feed Speed (WFS) adjustment knob.

5 2T Trigger Mode

When trigger is pressed, welding starts. When trigger is released, welding stops.

6 4T Trigger Mode

When trigger is pressed welding starts. When trigger is released, welding continues. When trigger is pressed and released a second time, welding stops.

7 Spot Weld Time

Use control to set time that welding arc is active before shutting off automatically. When this is selected, use the Wire Feed Speed adjustment knob or Sequencer P3 push buttons to change value. Default = 2.2 seconds (min = 0 sec, max = 10 sec).

☞ After turning On unit, display meter will show the latest trigger mode selected. Default is 2T.

5-8. Preparing Unit For Synergic MIG (GMAW And FCAW) Welding Process

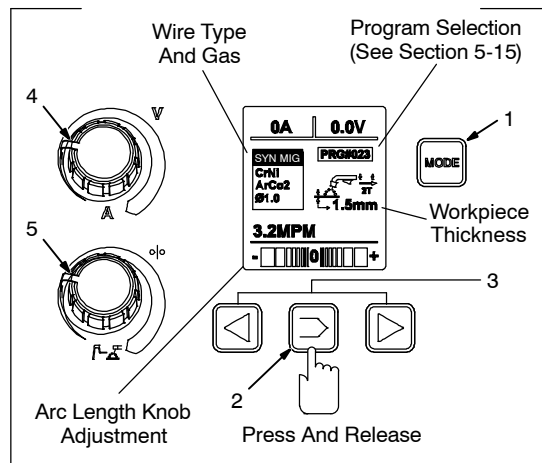
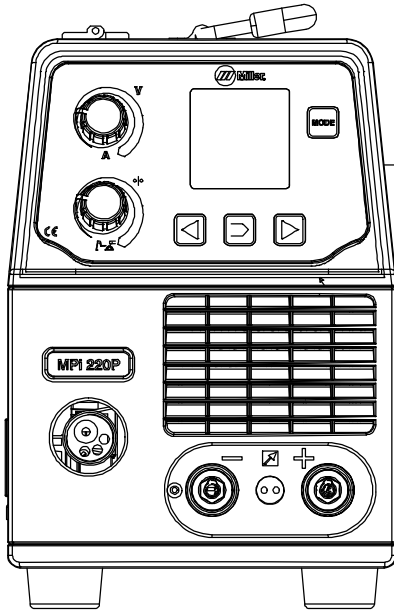
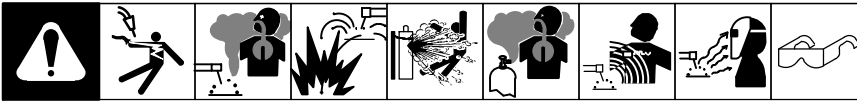

To select MIG welding process, proceed as follows:

Prepare unit according to Section 4.

Use a cable with correct adapter, connect gun to the MIG gun connector.

For GMAW process:

Connect wire drive lead to positive output terminal. Connect work lead to negative output terminal. See Section 4-5 for GMAW solid wire with shielding gas process. See Section 4-3 for installing gas supply.

For FCAW process:

Connect wire drive lead to negative output terminal. Connect work clamp lead to positive output terminal. See Section 4-5 for FCAW self-shielding wire no shielding gas process.

- 1 Process Selection P1 Push Button
- 2 Sequencer Set-Up P2 Push Button
- 3 Sequencer Adjustment/Operator Point Setting P3 Push Buttons (See Section 5-16)
- 4 Workpiece Thickness Adjustment Knob

Use knob to select desired workpiece thickness. Rotate knob clockwise to increase the thickness value.

- 5 Arc Length Control Knob

Use knob to select desired arc length value. It is the distance from end of wire electrode to the workpiece. Rotate knob clockwise to increase the arc length value (min = -40, max = +40). It allows setting inductance in MIG mode. In Pulse mode, this adjustment changes the arc cone by adjusting the preprogrammed factory pulse data.

Set MIG welding process using process selection P1 push button. To enter synergic MIG mode, press and release sequencer set-up P2 push button. Use sequencer adjustment P3 push buttons until SYN-MIG is displayed. Press and release P2 again to confirm setting.

In Synergic MIG mode, the operator may need to adjust welding data (wire type, wire diameter and gas type) and only one weld parameter. Generally, wire feed speed is adjusted and the synergic process automatically sets appropriate weld voltage. Synergic welding also sets many secondary welding parameters automatically for improved weld quality.

5-9. Synergic MIG Welding Set-Up Menu

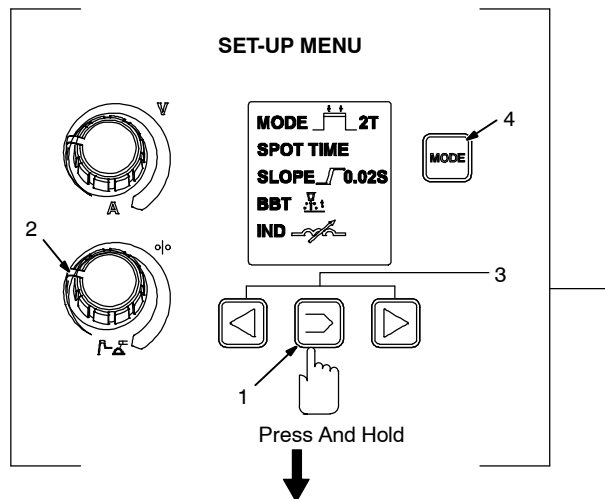
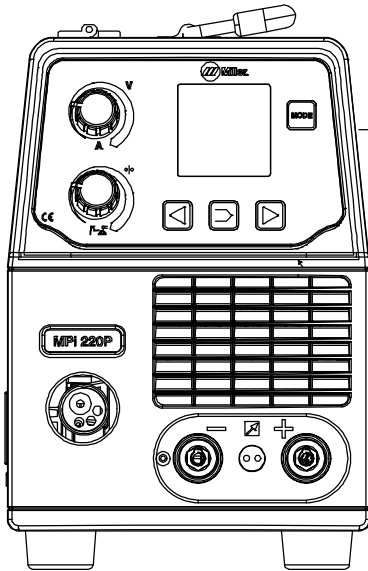
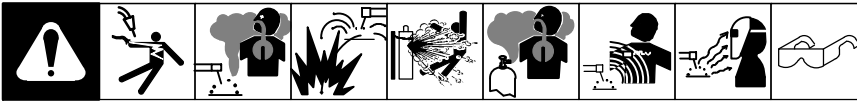

SCROLL THROUGH SEQUENCERS

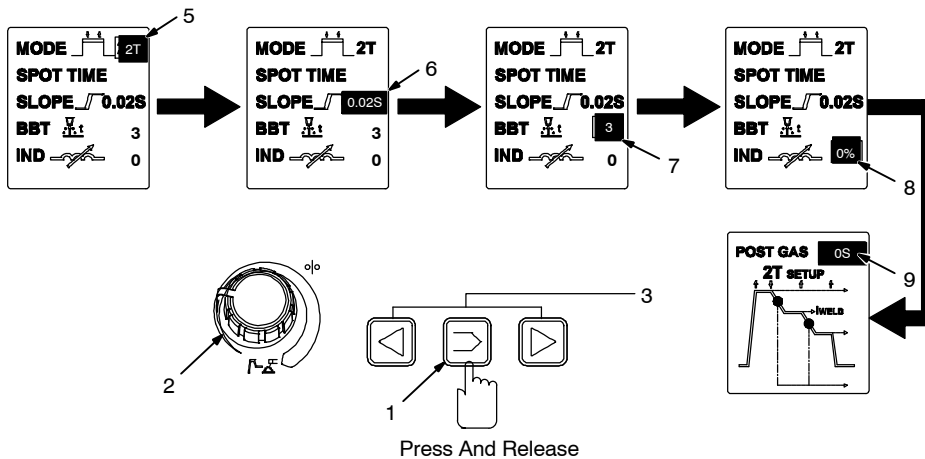

To enter MIG welding set-up menu, proceed as follows:

1 Sequencer Set-Up P2 Push Button

2 Arc Length Control Knob

While in the set-up menu, use knob to change sequencer parameters.

3 Sequencer Adjustment/Operator Point Setting P3 Push Buttons (See Section 5-16)

4 Process Selection P1 Push Button

Press and hold P2 push button to enter the set-up menu. Sequencers will be displayed on the digital meter display. To change parameters, use P3 push buttons or arc length control knob. To scroll through sequencers, press and release P2 push button. To exit set-up menu, press and release process selection P1 push button. Desired parameters will be stored.

5 Trigger Mode (2T/4T)

Use arc length control knob or sequencer adjustment P3 push buttons to change value (see Section 5-7).

6 Slope Time

Use Arc Length control knob to select amount of time that it takes to slope up/down from initial amperage to weld amperage. To disable, set to 0. When selected, use Arc Length control knob or Sequencer adjustment P3 push buttons to change value, Default = 0.2 seconds (min = 0 sec, max = 1.5 sec).

7 Burnback Time (BBT)

Use Arc Length control knob to select amount of time that welding wire stays energized after trigger is released. When selected, use Arc Length control knob to change value. Default = 5 (min = 0, max = 10)

Ref. 956142881_12-A

5-9. Synergic MIG Welding Set-Up Menu (Continued)

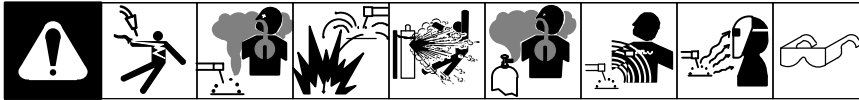

8 Percentage Of Weld Output Inductance

Use Arc Length control knob to select the percentage of welding inductance value. When selected, use the knob or sequencer P3 push buttons to change value. Default = 0% (min = -10%, max = +10%). Low inductance is used for most short arc applications, High inductance is for stainless steel and spray arc applications.

In short circuit GMAW welding, an increase in inductance will decrease the number of short circuit transfers per second (provided no other changes are made) and increase the arc-on time. The increased arc-on time makes the welding puddle more fluid.

9 Postflow Time

Use Arc Length control knob to set length of time gas flows after welding stops to protect the weld puddle. When this item is selected, use the Wire Feed Speed adjustment knob to change value. Default = 0.3 seconds (min = 0 sec, max = 3 sec).

5-10. Preparing Unit For Synergic Pulsed MIG (GMAW And FCAW) Welding Process

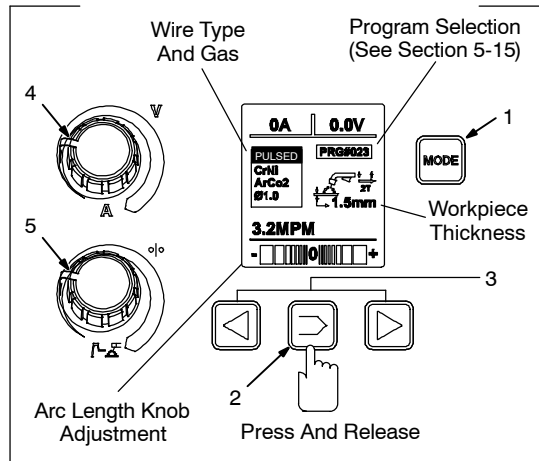
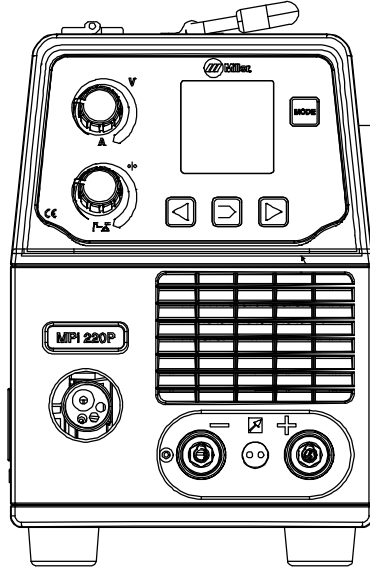
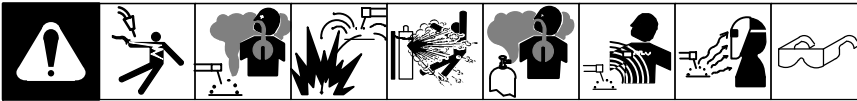

To select MIG welding process, proceed as follows:

Prepare unit according to Section 4.

Use a cable with correct adapter, connect gun to the MIG gun connector.

For GMAW process:

Connect wire drive lead to positive output terminal. Connect work lead to negative output terminal. See Section 4-5 for GMAW solid wire with shielding gas process. See Section 4-3 for installing gas supply.

For FCAW process:

Connect wire drive lead to negative output terminal. Connect work clamp lead to positive output terminal. See Section 4-5 for FCAW self-shielding wire no shielding gas process.

- 1 Process Selection P1 Push Button
- 2 Sequencer Set-Up P2 Push Button
- 3 Sequencer Adjustment/Operator Point Setting P3 Push Buttons (See Section 5-16)
- 4 Workpiece Thickness Adjustment Knob

Use Workpiece Thickness adjustment knob to select desired workpiece thickness. Rotate knob clockwise to increase the thickness value.

- 5 Arc Length Control Knob

Use knob to select desired arc length value. It is the distance from end of wire electrode to the workpiece. Rotate knob clockwise to increase the arc length value (min = -40, max = +40). It allows setting inductance in MIG mode. In Pulse mode, this adjustment changes the arc cone by adjusting the preprogrammed factory pulse data.

Ref. 956142881_13-A

5-10. Preparing Unit For Synergic Pulsed MIG (GMAW And FCAW) Welding Process (Continued)

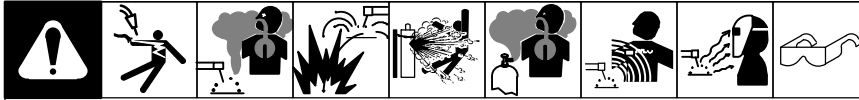

Set MIG welding process using process selection P1 push button. To enter synergic pulsed MIG mode, press and release sequencer set-up P2 push button. Use sequencer adjustment P3 push buttons until PULSED is displayed. Press and release P2 again to confirm setting.

☞ Synergic Pulsed MIG welding is a high quality welding process that produces very little spatter because the wire does not touch the weld puddle. Applications best suited for pulsed MIG are those currently using the short circuit transfer method for welding steel, 14 gauge (1.8 mm) and up. This process works well on thin metals such as stainless steel and aluminum.

☞ In Pulsed Synergic MIG mode, the operator may need to adjust welding data (wire type, wire diameter and gas type) and only one weld parameter. Generally, wire feed speed is adjusted and the synergic process automatically sets appropriate weld voltage. Synergic welding also sets many secondary welding parameters automatically for improved weld quality.

5-11. Synergic Pulsed MIG Welding Set-Up Menu

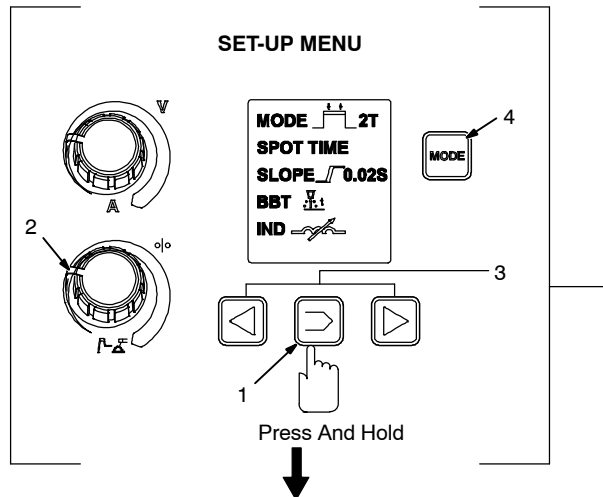
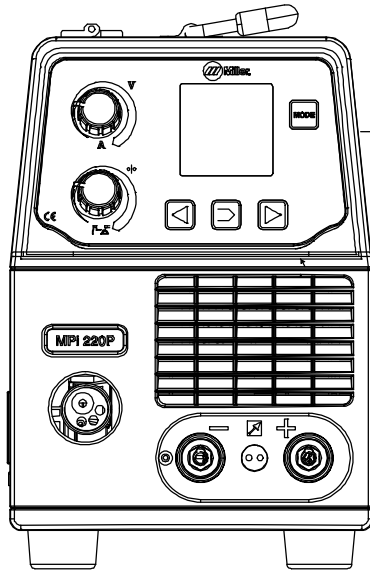
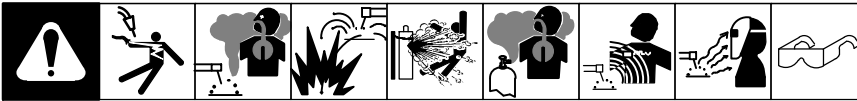

SCROLL THROUGH SEQUENCERS

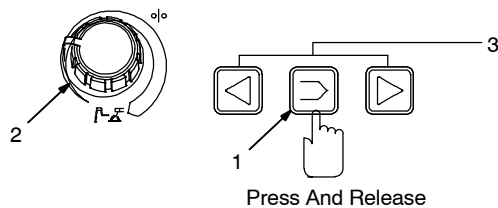
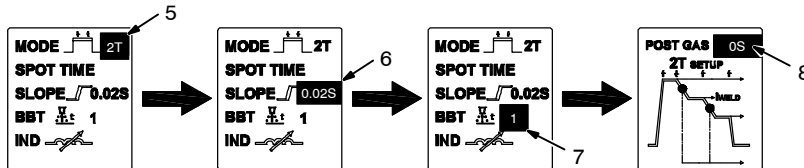

To enter MIG welding set-up menu, proceed as follows:

1 Sequencer Set-Up P2 Push Button

2 Arc Length Control Knob

While in the set-up menu, use knob to change sequencer parameters.

3 Sequencer Adjustment/Operator Point Setting P3 Push Buttons (See Section 5-16)

4 Process Selection P1 Push Button

Press and hold P2 push button to enter the set-up menu. Sequencers will be displayed on the digital meter display. To change parameters, use P3 push buttons or arc length control knob. To scroll through sequencers, press and release P2 push button. To exit set-up menu, press and release process selection P1 push button. Desired parameters will be stored.

5 Trigger Mode (2T/4T)

Use arc length control knob or sequencer adjustment P3 push buttons to change value (see Section 5-7).

6 Slope Time

Use Arc Length control knob to select amount of time that it takes to slope up/down from initial amperage to weld amperage. To disable, set to 0. When selected, use Arc Length control knob or Sequencer adjustment P3 push buttons to change value, Default = 0.2 seconds (min = 0 sec, max = 1.5 sec).

7 Burnback Time (BBT)

This value is set to 1 second.

8 Postflow Time

Use Arc Length control knob to set length of time gas flows after welding stops to protect the weld puddle. When this item is selected, use the Wire Feed Speed adjustment knob to change value. Default = 0.3 seconds (min = 0 sec, max = 3 sec).

In Synergic Pulsed MIG, welding inductance cannot be set.

5-12. 4T Trigger Set-Up Menu (Synergic Pulsed MIG Welding Only)

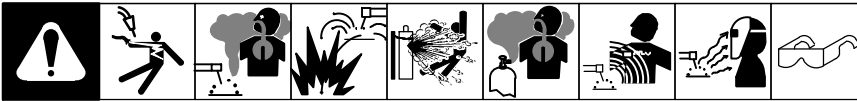

To enter 4T trigger set-up menu:

Follow instructions listed in Section 5-7.

- 1 Postflow Time (See Section 5-11)
- 2 Arc Power (Hot Start) Percentage

Percent increase of welding current to make arc start easier. When this item is selected, use the Arc Length control knob or Sequencer adjustment P3 push buttons to change value. Default = 120% (min = 100%, max = 150%).

- 3 Welding Current Percentage

Percent reduction of welding current during the crater fill process. When this item is selected, use the Arc Length control knob or Sequencer adjustment P3 push buttons to change value. Default = 80% (min = 30%, max = 100%).

- 4 Slope Down Time

Time necessary for current decrease when using slope down control. When this item is selected, use the Arc Length control knob or Sequencer adjustment P3 push buttons to change value. Default = 0.5 seconds (min = 0.1 sec, max = 2.0 sec).

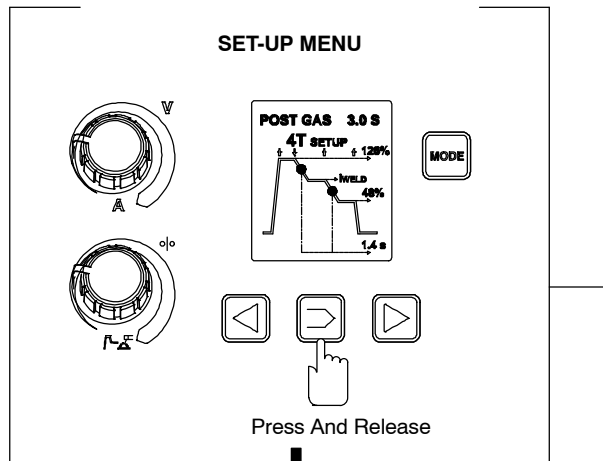
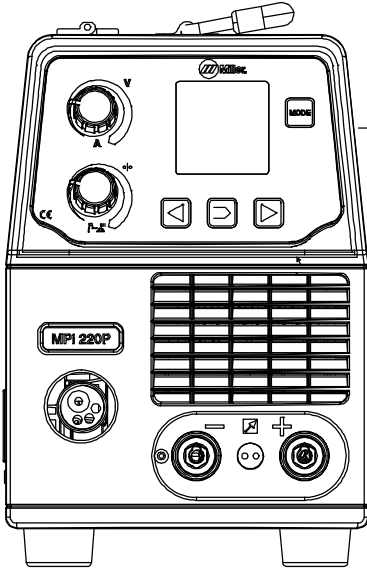

SCROLL THROUGH PARAMETERS

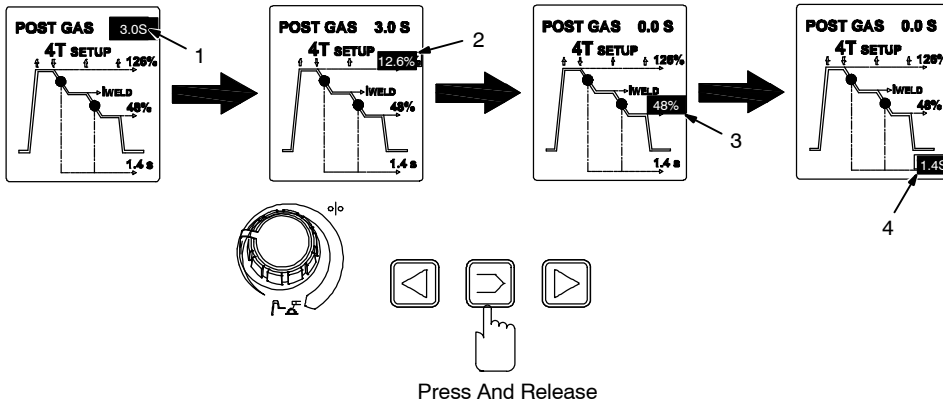

Ref. 956142881_15-A

5-13. Welding Wire Loading Settings

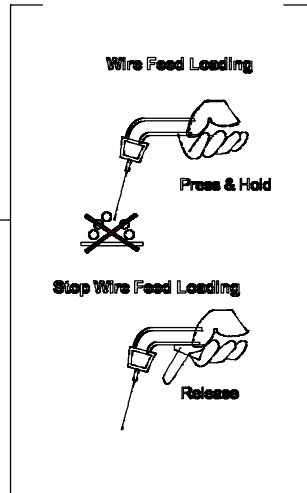
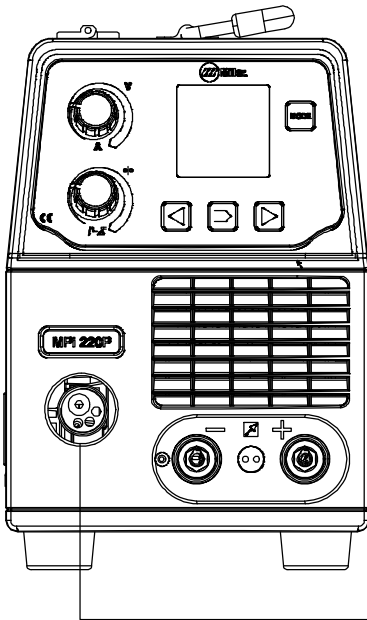
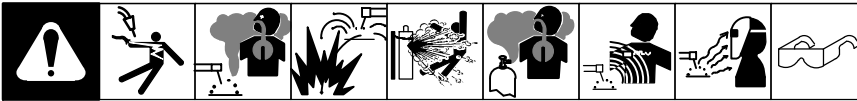

Prepare unit for welding wire loading as follows:

- Install wire spool and adjust hub tension (see Section 4-7).
- Use proper drive rolls and wire guide (see Section 4-8).
- Thread welding wire and adjust pressure roll tension (see Section 4-12).

Without starting a weld, press and hold torch trigger for three seconds to load welding wire.

☞ After pressing and holding the torch trigger, gas valve and input power contactor are disabled. This method prevents the risks of arc ignitions due to contact with conductive surfaces during wire loading. Welding wire will be loaded at a wire feed value of about 11 mpm. The wire feed speed is only measured in meters per minute.

To stop loading wire, release torch trigger.

Ref. 956142881_16-A

5-14. Resetting Unit To Factory Default Settings

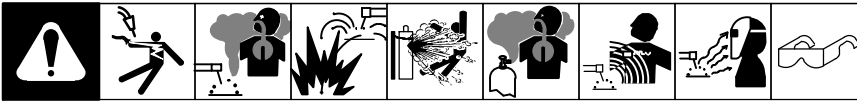

This procedure will delete all operator specified parameters and recall all factory parameters.

1 Power Switch

Use power switch to turn unit on. When Miller appears on the display, press and release sequencer set-up P2 push button. Basic set-up menu will be displayed. Press and hold P2 until OK is displayed by resetting parameters. Factory defaults are now restored.

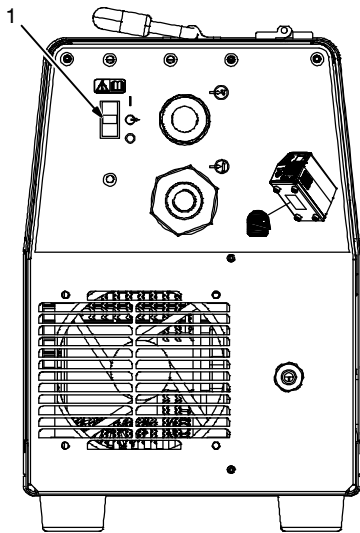
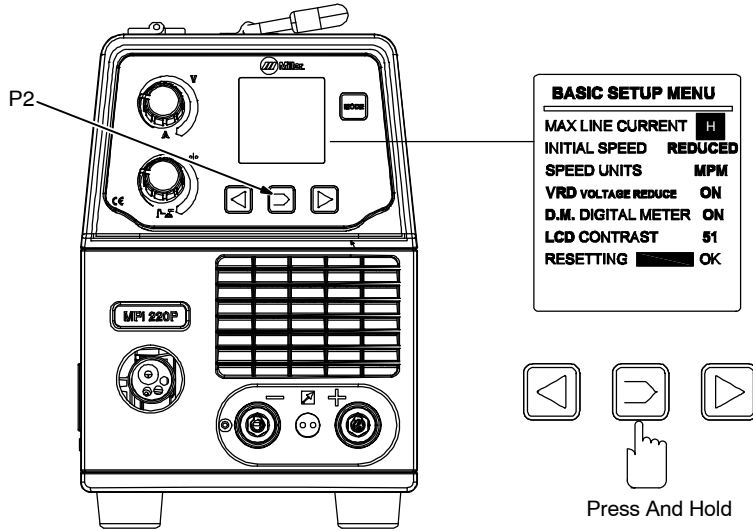

956142881_24-B

5-15. Loading A Program

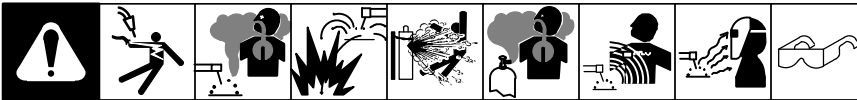

To load programs, press and release sequencer set-up P2 push button (see Section 5-8 and Section 5-10) until program number is displayed. Use sequencer adjustment P3 push buttons to select desired program. Press P2 push button to confirm selected program.

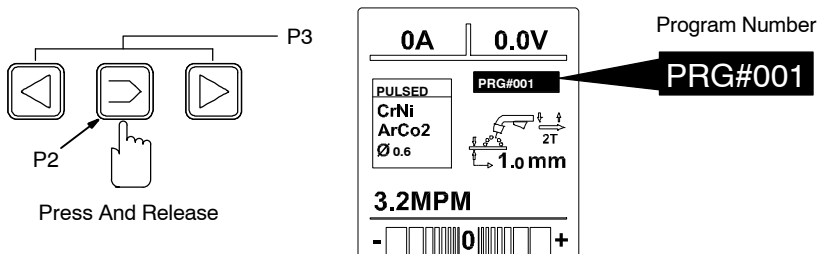

Ref. 956142887-A

5-16. Operator Point MIG Parameters Loading

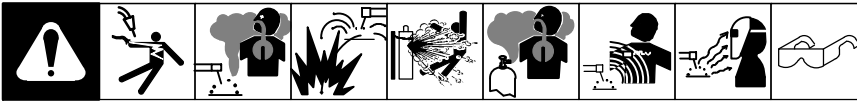

This setting is only available in MIG mode. It allows the operator to load and save desired specified weld parameters and recall them when required.

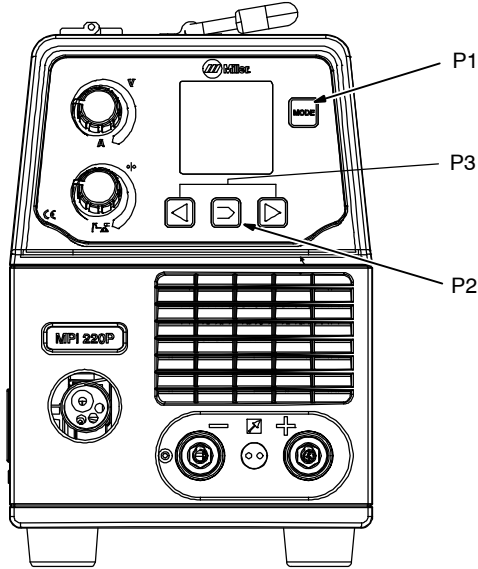

Store parameters:

Press and release P3 push buttons simultaneously to enter the operator point set-up menu. Use P3 push buttons to select desired position where parameters will be stored. Press and hold Sequencer P2 push button for about 10 seconds to save parameters. Saving OK will be displayed on the digital meter. Press and release process selection P1 push button to exit set-up menu.

Recall parameters:

Press and release P3 push buttons simultaneously to enter the operator point set-up menu. Use P3 push buttons to select desired stored parameters. Press and release Sequencer P2 push button to load parameters.

STORE PARAMETERS

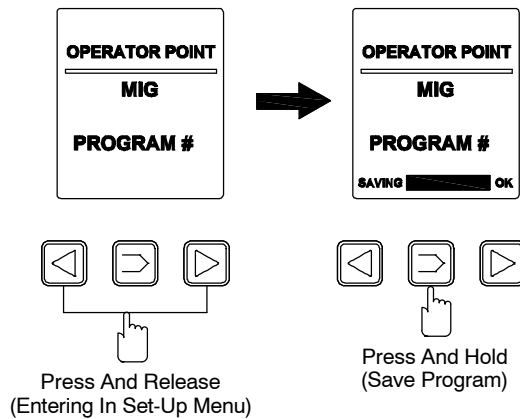

RECALL PARAMETERS

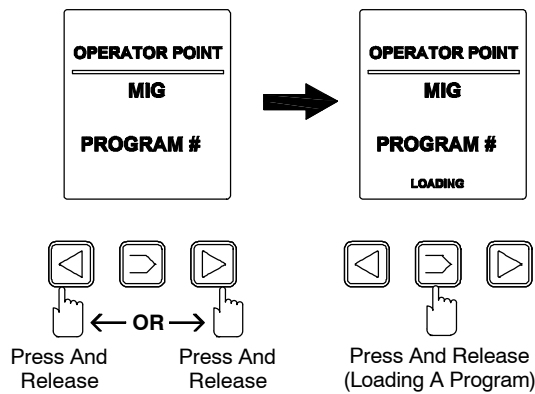

Ref. 956142881_22-A

5-17. Rated Supply Current $I_1 = 16$ Amps Setting

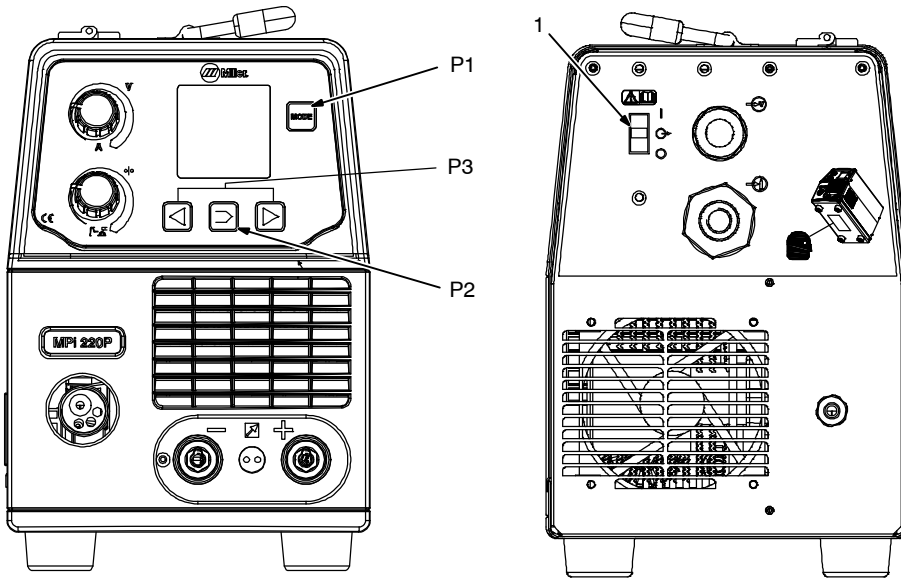
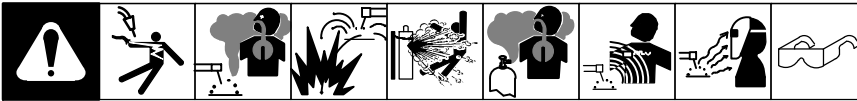

This setting allows the operator to use the unit with a maximum of 16 amperes of rated supply current I_1 .

Before setting the rated supply current I_1 ,

⚠ Follow the Electromagnetic Compatibility (EMC) information according to Section 3-2.

⚠ Connect single phase input power according to Section 4-11.

☞ *By setting a lower rated supply current I_1 , the unit cannot have the same performance then that listed in Section 3-3 and 4-10 under normal operating conditions.*

1 Power Switch

Use power switch to turn unit on. When Miller appears on the display, press and release sequencer set-up P2 push button. Unit is at default setting of H (high rated supply current I_1). Use sequencer parameters adjustment P3 push buttons to set unit to L (low rated supply current I_1 , max value = 16 amperes). Press and release P2 to confirm selection. Press and release process selection P1 push button to exit menu.

The next time the unit is turned on, the latest settings will be retained.

☞ *To return to factory default settings, see Section 5-14.*

HIGH RATED SUPPLY CURRENT

LOW RATED SUPPLY CURRENT

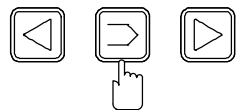
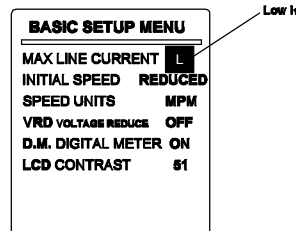
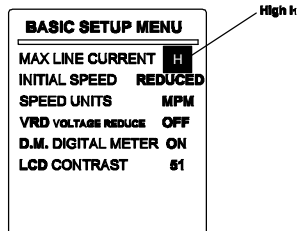

Press And Release
(Entering In Set-Up Menu)

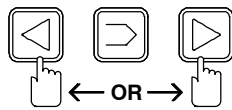

Press And Release Press And Release
(To Change Parameter)

5-18. Basic Set-Up Menu Parameters Settings

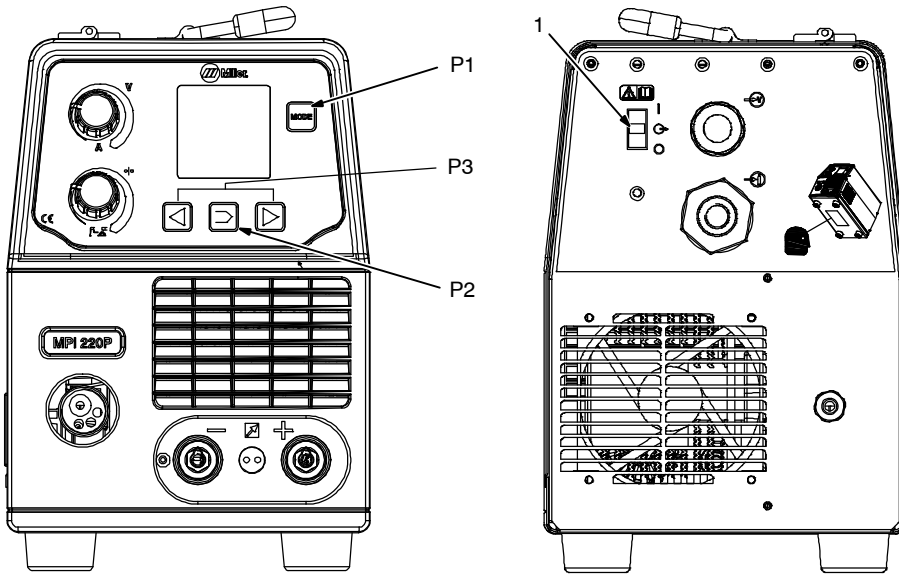
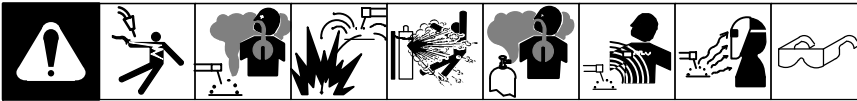

1 Power Switch

Use power switch to turn unit on. When Miller appears on the display, press and release sequencer set-up P2 push button. Basic set-up menu will be displayed.

2 Initial Wire Feed Speed (WFS) Settings

Press and release P2 push button to select desired parameter. Use P3 push buttons to change value. This value is either "reduced" or "normal". Default is set to "reduced".

3 Wire Feed Speed (WFS) Unit Of Measurement Settings

Press and release P2 push button to select desired parameter. Use P3 push buttons to change value. Available units of measurement are either MPM (meters per minute) or IPM (inches per minute). Default is set to "MPM".

4 Voltage Reduction Device (VRD) Settings

Press and release P2 push button to select desired parameter. Use P3 push buttons to change value. This value is either "OFF" or "ON". Default is set to "ON".

5 Digital Meter Display Setting

Press and release P2 push button to select desired parameter. Use P3 push buttons to change value. This value is either "OFF" or "ON". Default is set to "ON".

6 LCD Contrast Settings

Press and release P2 push button to select desired parameter. Use P3 push buttons to change value. Default is set to "51" (min = 30, max = 63).

Press and release process selection P1 push button to exit menu. The next time the unit is turned on, the latest settings will be retained.

To return to factory default settings, see Section 5-14.

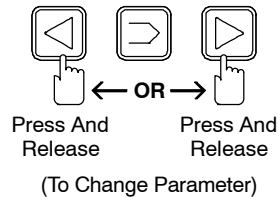
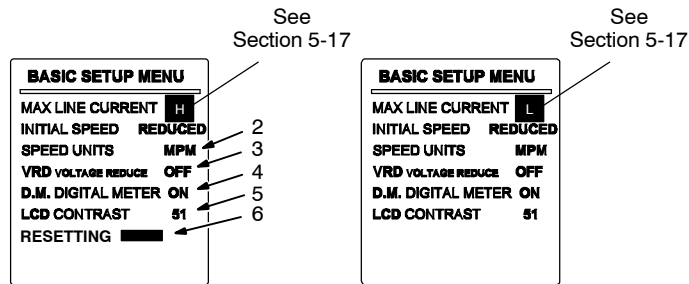

SECTION 6 – MAINTENANCE & TROUBLESHOOTING

6-1. Routine Maintenance

		Disconnect power before maintaining.		<i>Maintain more often during severe conditions.</i>	
	✓ = Check ◇ = Change ● = Clean ☆ = Replace * To be done by Factory Authorized Service Agent	Reference			
Every 3 Months	☆ Unreadable Labels	● Weld Terminals	✓ ☆ Weld Cables		
Every 6 Months	● Inside Unit	✓ Apply Light Coat Of Oil Or Grease To Drive Motor Shaft	● Clean Drive Rolls		

6-2. Welding Gun And Wire Drive Assembly

		<p>1 Welding Gun Check gun liner for blockage or kinks.</p> <p>2 Wire Drive Assembly Check for jammed wire, binding drive gear or misaligned drive rolls. Allow cooling period. Close door.</p>
956142881_3-A		

6-3. Unit Overload

Thermal switches TP1 and TP2 located on the primary and secondary heatsink protect the unit from damage due to overheating. If TP1 and/or TP2 have opened due to overheating, wait for unit to cool allowing fan motor to run before trying to weld. If unit is cool and no weld output continues, contact Factory Authorized Service Agent.

6-4. Troubleshooting

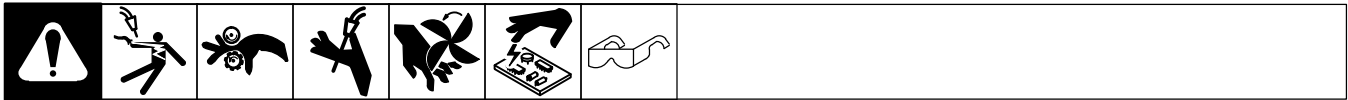

A. MIG (GMAW) Welding

Trouble	Remedy
No weld output; wire does not feed.	Be sure line disconnect switch is On (see Section 4-11).
	Replace building line fuse or reset circuit breaker if open (see Section 4-11).
	Secure gun trigger connections (see welding gun Owner's Manual).
	Check continuity of power switch S1 and replace if necessary.
	Have Factory Authorized Service Agent check main transformer T1 for signs of winding failure. Check continuity across windings and check for proper connections. Check secondary voltages. Replace T1 if necessary.
	Have Factory Authorized Service Agent check continuity of thermostats TP1 and TP2. Replace TP1 and/or TP2 if necessary.
	Have Factory Authorized Service Agent check main control board PC2 and connections, and replace if necessary.
No weld output; wire feeds.	Have Factory Authorized Service Agent check all board connections and main control board.
	Connect work clamp to get good metal to metal contact.
	Replace contact tip (see welding gun Owner's Manual).
	An overload condition occurred (see Section 6-3).
	Have Factory Authorized Service Agent check primary and secondary power circuit of the unit.
	Have Factory Authorized Service Agent check main transformer T1 for signs of winding failure. Check continuity across windings and check for proper connections. Check secondary voltages. Replace T1 if necessary.
Low weld output.	Have Factory Authorized Service Agent check voltage switch(es), and replace if necessary.
	Connect unit to proper input voltage or check for low line voltage (see Section 4-11).
Low, high, or erratic wire speed.	Readjust front panel settings (see Section 5).
	Change to correct size drive rolls (see Section 4-8).
	Readjust drive roll pressure (see Section 4-12).
	Replace inlet guide, contact tip, and/or liner if necessary (see welding gun Owner's Manual).
	Have Factory Authorized Service Agent check Wire Speed control, and replace if necessary.
	Have Factory Authorized Service Agent check motor control board PC4 and connections, and replace if necessary.
No wire feed.	Have Factory Authorized Service Agent check main control board.
	Rotate Wire Speed control to higher setting (see Section 5).
	Clear obstruction in gun contact tip or liner (see welding gun Owner's Manual).
	Readjust drive roll pressure (see Section 4-12).
	Change to correct size drive rolls (see Section 4-8).
	Rethread welding wire (see Section 4-12).
	Check gun trigger and leads. Repair or replace gun if necessary.
Have Factory Authorized Service Agent check main control board.	

B. Stick (SMAW) Welding

Trouble	Remedy
Hard starts, poor welding characteristics, unusual spattering.	Use proper type and size of electrode.
	Check electrode polarity and reverse in necessary; check and correct poor connections
	Make sure a remote control is not connected.

C. TIG (GTAW) Welding

Trouble	Remedy
Wandering arc, hard starts, poor welding characteristics, spattering problems.	Use proper type and size of tungsten.
	Use properly prepared tungsten.
	Check electrode polarity and reverse if necessary.
Tungsten electrode oxidizing and not remaining bright after welding.	Shield weld zone from drafts.
	Check for correct type shielding gas.
	Check and tighten gas fittings.
	Check electrode polarity and reverse if necessary.

SECTION 7 – ELECTRICAL DIAGRAMS

⚠ WARNING 	<ul style="list-style-type: none"> • Do not touch live electrical parts. • Disconnect input power or stop engine before servicing. • Do not operate with covers removed.
ELECTRIC SHOCK HAZARD	<ul style="list-style-type: none"> • Have only qualified persons install, use, or service this unit.

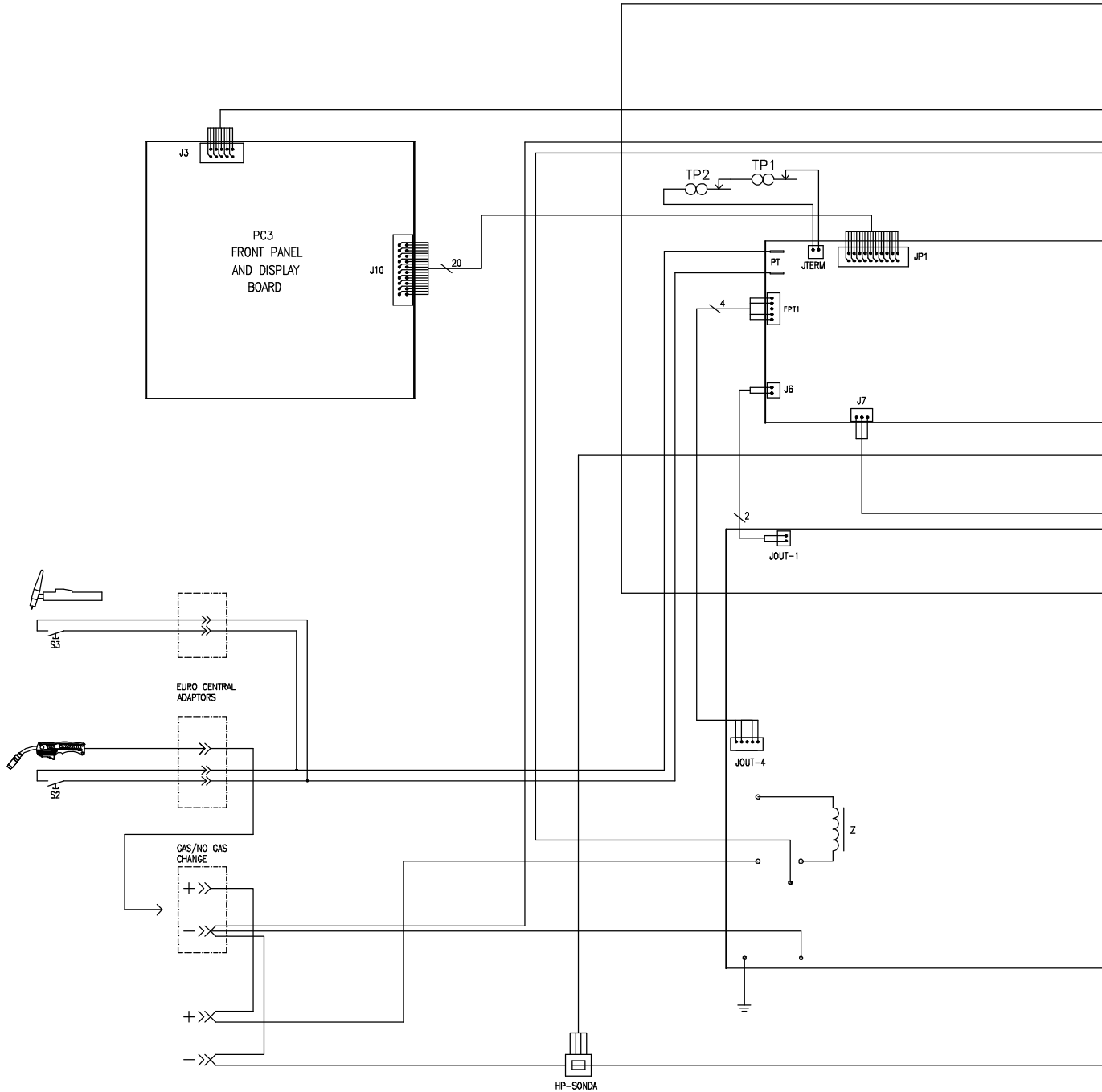
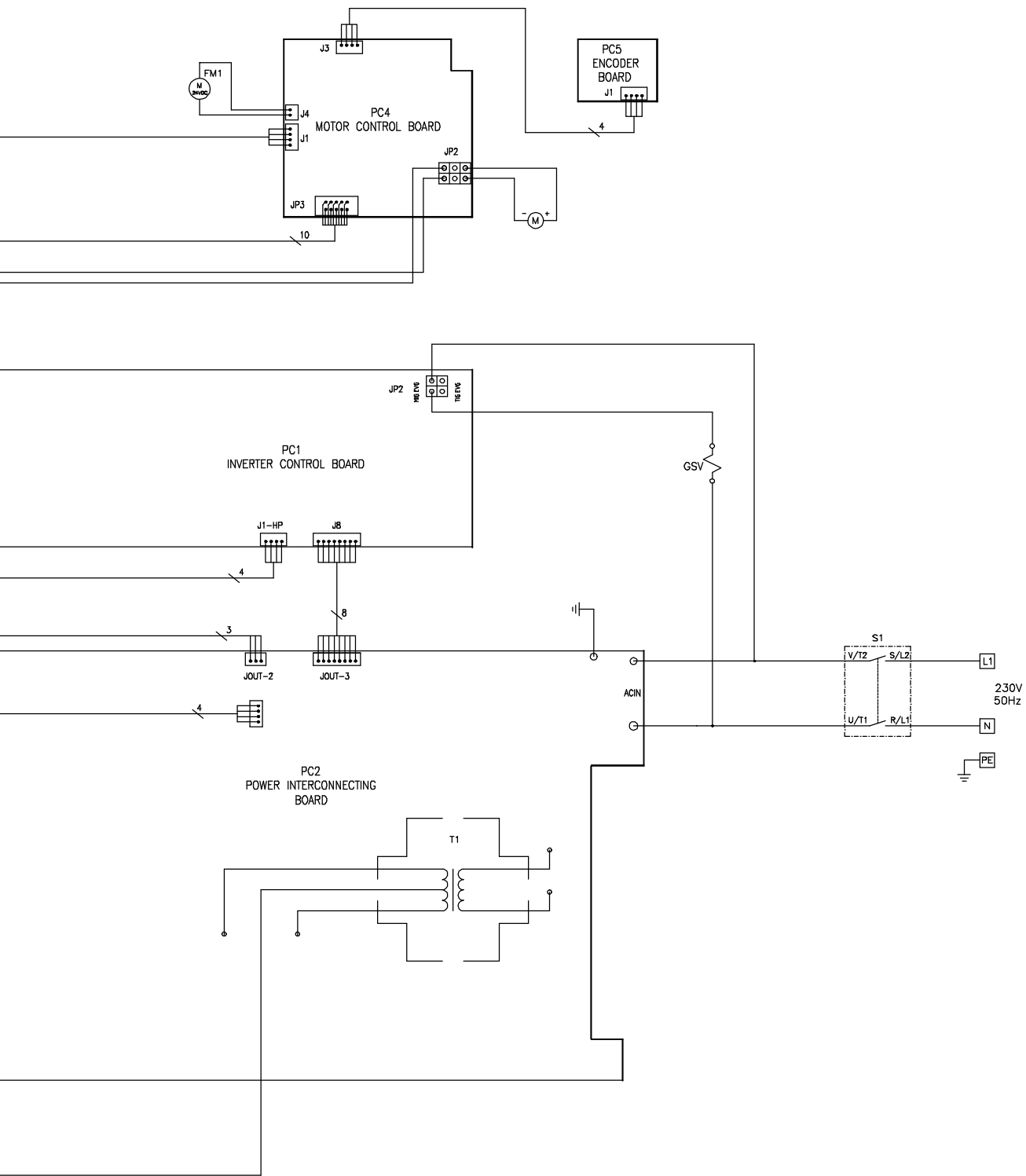

Figure 7-1. Circuit Diagram For Welding Power Source



SECTION 8 – MIG WELDING (GMAW) GUIDELINES



mig1 2009-12

8-1. Typical MIG Process Connections

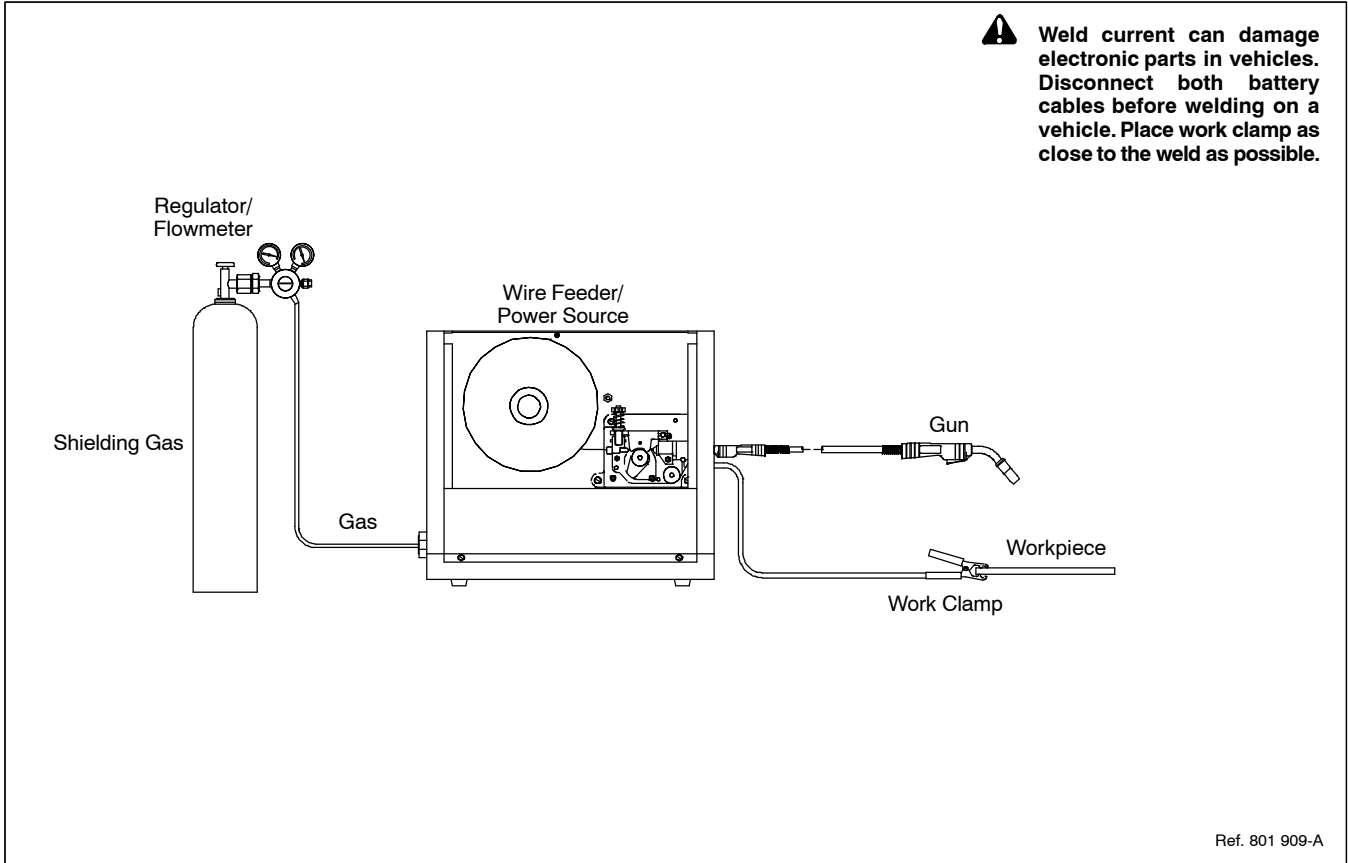

8-2. Typical MIG Process Control Settings

☞ These settings are guidelines only. Material and wire type, joint design, fitup, position, shielding gas, etc. affect settings. Test welds to be sure they comply to specifications.

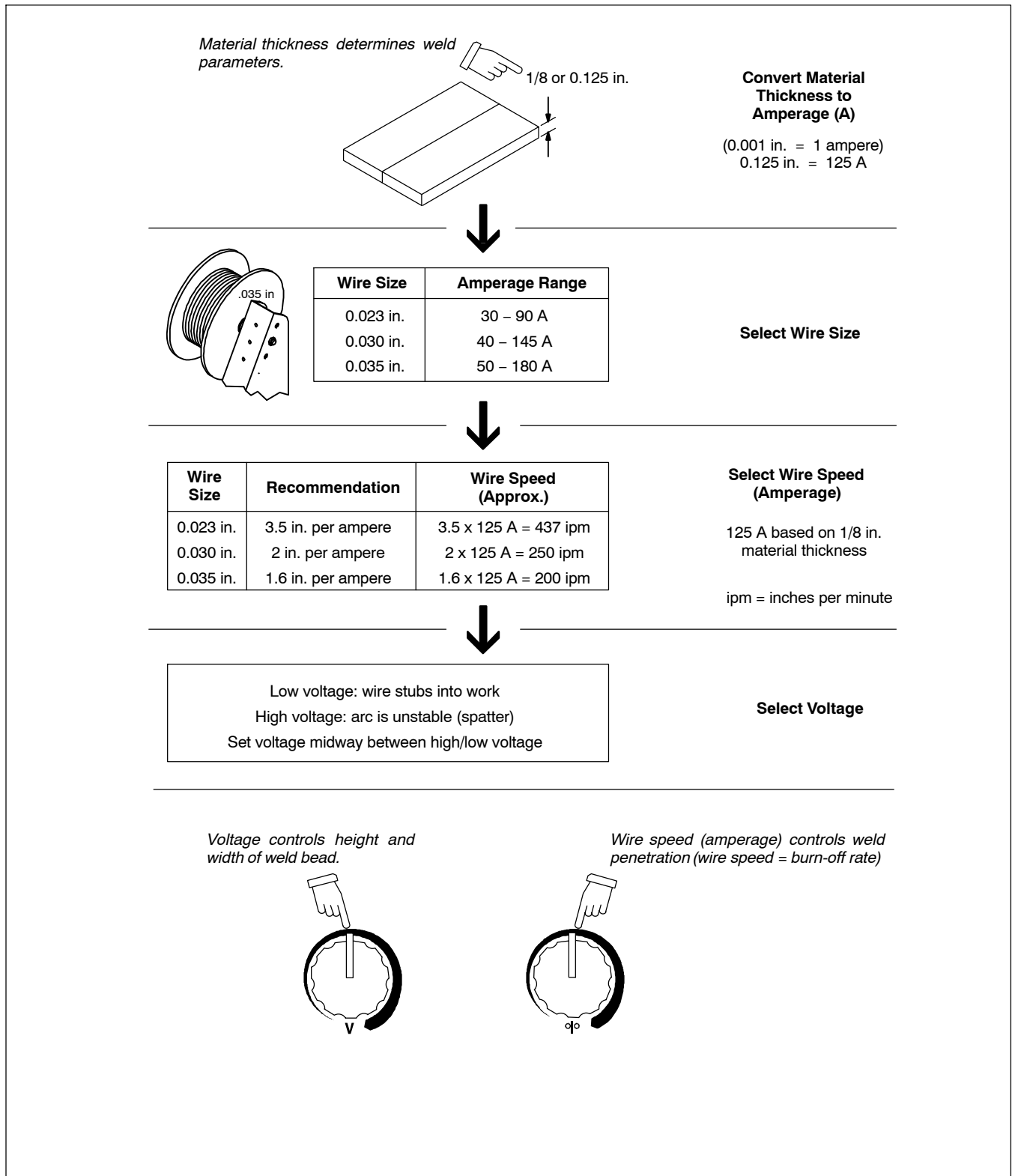

8-3. Holding And Positioning Welding Gun

☞ Welding wire is energized when gun trigger is pressed. Before lowering helmet and pressing trigger, be sure wire is no more than 1/2 in. (13 mm) past end of nozzle, and tip of wire is positioned correctly on seam.

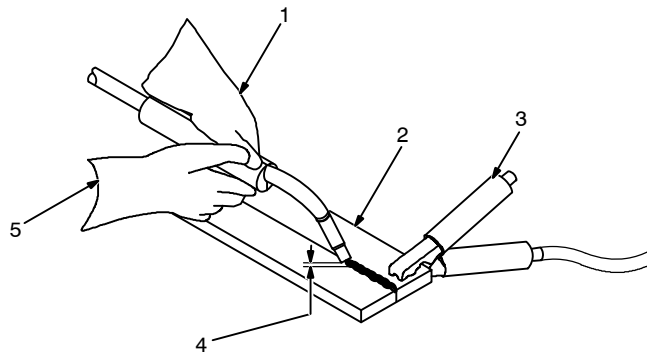

- 1 Hold Gun and Control Gun Trigger
- 2 Workpiece
- 3 Work Clamp
- 4 Electrode Extension (Stickout) 1/4 to 1/2 in. (6 To 13 mm)
- 5 Cradle Gun and Rest Hand on Workpiece

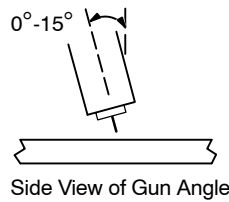
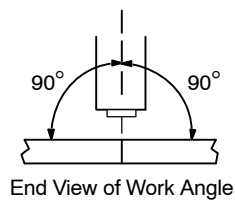

GROOVE WELDS

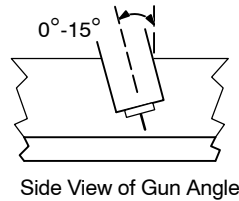
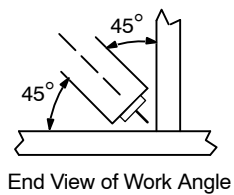

FILLET WELDS

S-0421-A

8-4. Conditions That Affect Weld Bead Shape

☞ Weld bead shape depends on gun angle, direction of travel, electrode extension (stickout), travel speed, thickness of base metal, wire feed speed (weld current), and voltage.

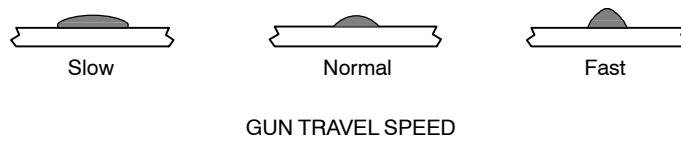
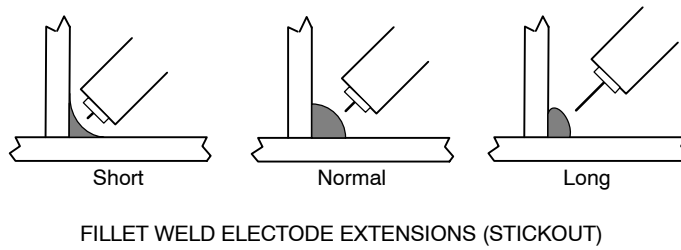
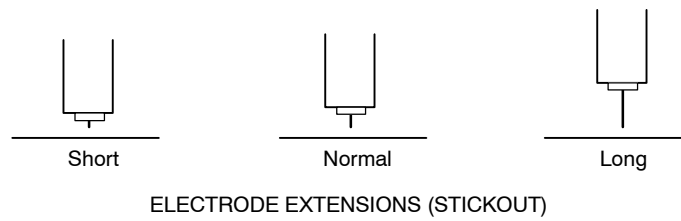
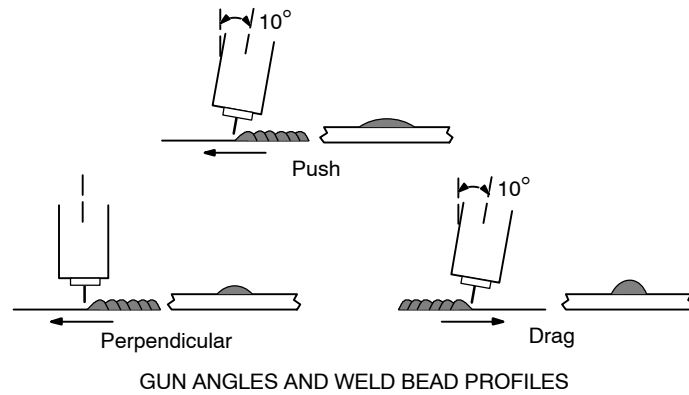

S-0634

8-5. Gun Movement During Welding

☞ Normally, a single stringer bead is satisfactory for most narrow groove weld joints; however, for wide groove weld joints or bridging across gaps, a weave bead or multiple stringer beads works better.

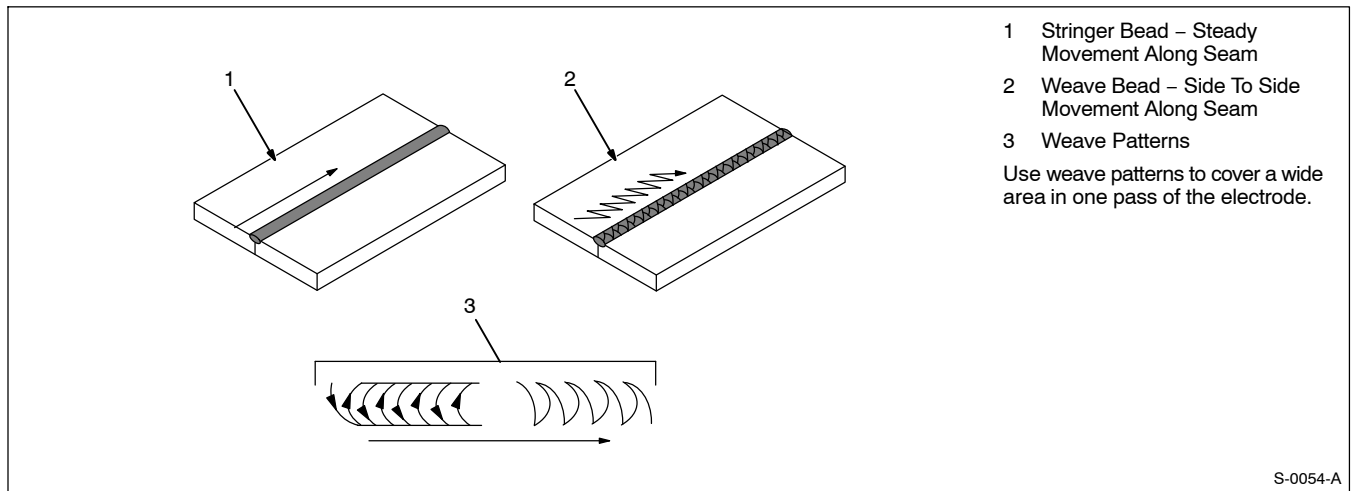

- 1 Stringer Bead – Steady Movement Along Seam
- 2 Weave Bead – Side To Side Movement Along Seam
- 3 Weave Patterns

Use weave patterns to cover a wide area in one pass of the electrode.

S-0054-A

8-6. Poor Weld Bead Characteristics

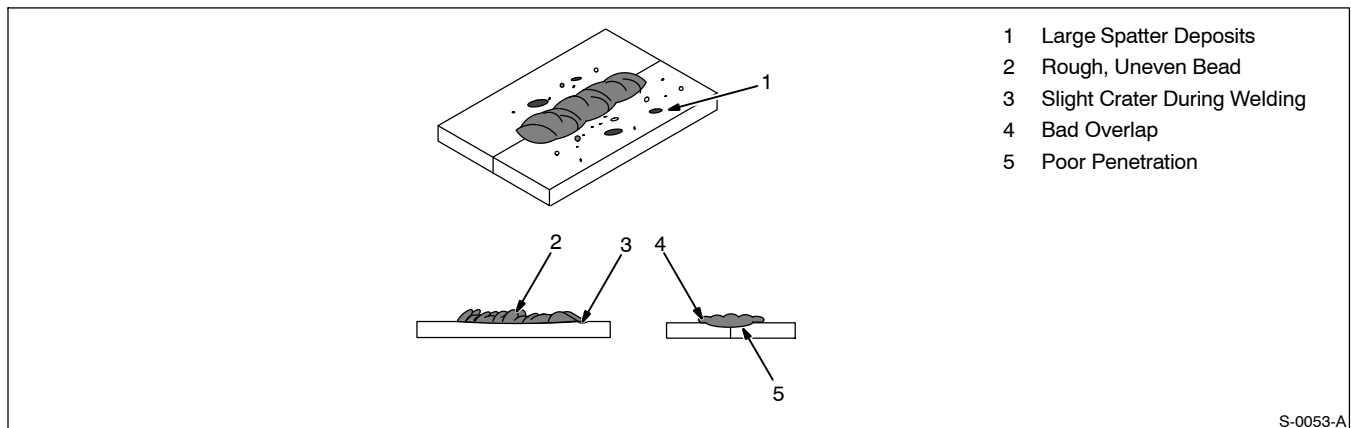

- 1 Large Spatter Deposits
- 2 Rough, Uneven Bead
- 3 Slight Crater During Welding
- 4 Bad Overlap
- 5 Poor Penetration

S-0053-A

8-7. Good Weld Bead Characteristics

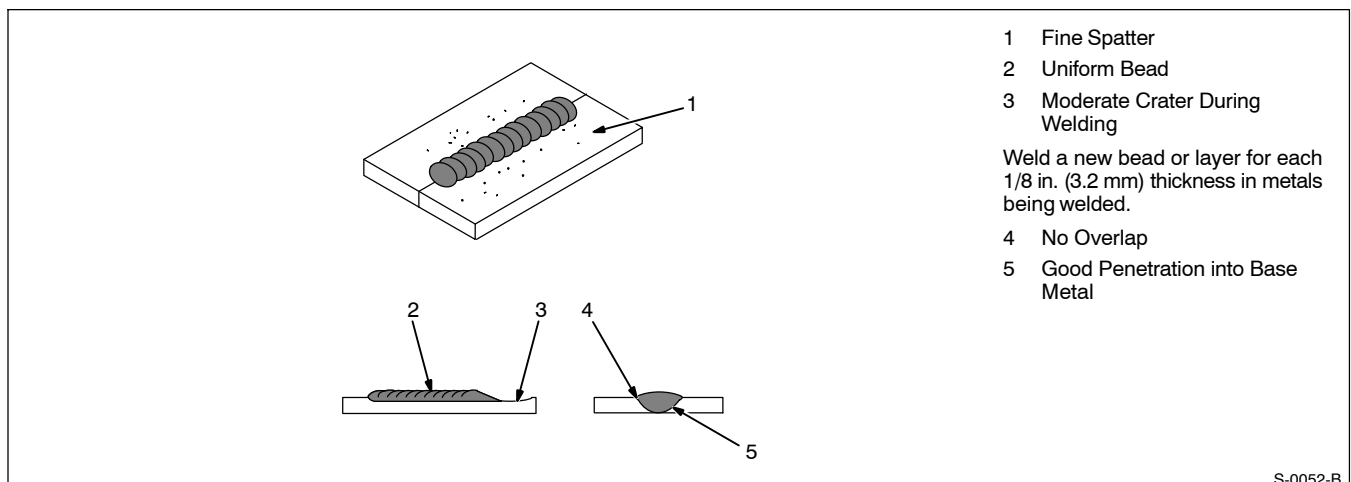

- 1 Fine Spatter
- 2 Uniform Bead
- 3 Moderate Crater During Welding

Weld a new bead or layer for each 1/8 in. (3.2 mm) thickness in metals being welded.

- 4 No Overlap
- 5 Good Penetration into Base Metal

S-0052-B

8-8. Troubleshooting – Excessive Spatter

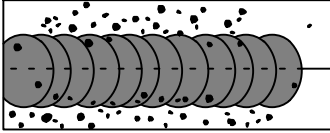

Excessive Spatter – scattering of molten metal particles that cool to solid form near weld bead.

S-0636

Possible Causes	Corrective Actions
Wire feed speed too high.	Select lower wire feed speed.
Voltage too high.	Select lower voltage range.
Electrode extension (stickout) too long.	Use shorter electrode extension (stickout).
Workpiece dirty.	Remove all grease, oil, moisture, rust, paint, undercoating, and dirt from work surface before welding.
Insufficient shielding gas at welding arc.	Increase flow of shielding gas at regulator/flowmeter and/or prevent drafts near welding arc.
Dirty welding wire.	Use clean, dry welding wire.
	Eliminate pickup of oil or lubricant on welding wire from feeder or liner.
Incorrect polarity.	Check polarity required by welding wire, and change to correct polarity at welding power source.

8-9. Troubleshooting – Porosity

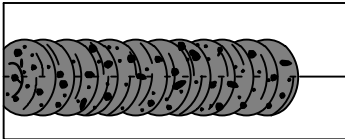

Porosity – small cavities or holes resulting from gas pockets in weld metal.

S-0635

Possible Causes	Corrective Actions
Insufficient shielding gas at welding arc.	Increase flow of shielding gas at regulator/flowmeter and/or prevent drafts near welding arc.
	Remove spatter from gun nozzle.
	Check gas hoses for leaks.
	Place nozzle 1/4 to 1/2 in. (6-13 mm) from workpiece.
	Hold gun near bead at end of weld until molten metal solidifies.
Wrong gas.	Use welding grade shielding gas; change to different gas.
Dirty welding wire.	Use clean, dry welding wire.
	Eliminate pick up of oil or lubricant on welding wire from feeder or liner.
Workpiece dirty.	Remove all grease, oil, moisture, rust, paint, coatings, and dirt from work surface before welding.
	Use a more highly deoxidizing welding wire (contact supplier).
Welding wire extends too far out of nozzle.	Be sure welding wire extends not more than 1/2 in. (13 mm) beyond nozzle.

8-10. Troubleshooting – Excessive Penetration

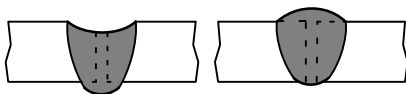

Excessive Penetration Good Penetration

Excessive Penetration – weld metal melting through base metal and hanging underneath weld.

S-0639

Possible Causes	Corrective Actions
Excessive heat input.	Select lower voltage range and reduce wire feed speed.
	Increase travel speed.

8-11. Troubleshooting – Lack Of Penetration

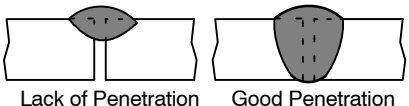
 <p>Lack of Penetration Good Penetration</p>		<p>Lack Of Penetration – shallow fusion between weld metal and base metal.</p>	S-0638
Possible Causes	Corrective Actions		
Improper joint preparation.	Material too thick. Joint preparation and design must provide access to bottom of groove while maintaining proper welding wire extension and arc characteristics.		
Improper weld technique.	Maintain normal gun angle of 0 to 15 degrees to achieve maximum penetration.		
	Keep arc on leading edge of weld puddle.		
	Be sure welding wire extends not more than 1/2 in. (13 mm) beyond nozzle.		
Insufficient heat input.	Select higher wire feed speed and/or select higher voltage range.		
	Reduce travel speed.		
Incorrect polarity.	Check polarity required by welding wire, and change to correct polarity at welding power source.		

8-12. Troubleshooting – Incomplete Fusion

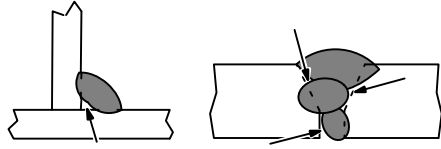
		<p>Incomplete Fusion – failure of weld metal to fuse completely with base metal or a preceding weld bead.</p>	S-0637
Possible Causes	Corrective Actions		
Workpiece dirty.	Remove all grease, oil, moisture, rust, paint, undercoating, and dirt from work surface before welding.		
Insufficient heat input.	Select higher voltage range and/or adjust wire feed speed.		
Improper welding technique.	Place stringer bead in proper location(s) at joint during welding.		
	Adjust work angle or widen groove to access bottom during welding.		
	Momentarily hold arc on groove side walls when using weaving technique.		
	Keep arc on leading edge of weld puddle.		
	Use correct gun angle of 0 to 15 degrees.		

8-13. Troubleshooting – Burn-Through

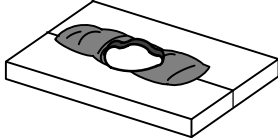
		<p>Burn-Through – weld metal melting completely through base metal resulting in holes where no metal remains.</p>	S-0640
Possible Causes	Corrective Actions		
Excessive heat input.	Select lower voltage range and reduce wire feed speed.		
	Increase and/or maintain steady travel speed.		

8-14. Troubleshooting – Waviness Of Bead

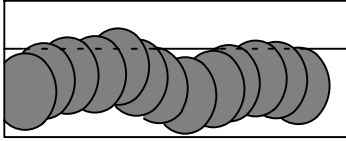

Waviness Of Bead – weld metal that is not parallel and does not cover joint formed by base metal.

S-0641

Possible Causes	Corrective Actions
Welding wire extends too far out of nozzle.	Be sure welding wire extends not more than 1/2 in. (13 mm) beyond nozzle.
Unsteady hand.	Support hand on solid surface or use two hands.

8-15. Troubleshooting – Distortion

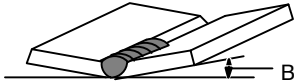

Base metal moves in the direction of the weld bead.

Distortion – contraction of weld metal during welding that forces base metal to move.

S-0642

Possible Causes	Corrective Actions
Excessive heat input.	Use restraint (clamp) to hold base metal in position.
	Make tack welds along joint before starting welding operation.
	Select lower voltage range and/or reduce wire feed speed.
	Increase travel speed.
	Weld in small segments and allow cooling between welds.

8-16. Common MIG Shielding Gases

This is a general chart for common gases and where they are used. Many different combinations (mixtures) of shielding gases have been developed over the years. The most commonly used shielding gases are listed in the following table.

Gas	Application			
	Spray Arc Steel	Short Circuiting Steel	Short Circuiting Stainless Steel	Aluminum
Argon				X
Argon + 25% CO ₂		X		
80% or greater Argon + balance CO ₂ or Oxygen	X	X ¹		
100% CO ₂		X		
Tri-Mix ²			X	

1 Limited short circuiting use

2 90% HE + 7-1/2% AR + 2-1/2% CO₂

8-17. Troubleshooting Guide For Semiautomatic Welding Equipment

Problem	Probable Cause	Remedy
Wire feed motor operates, but wire does not feed.	Too little pressure on wire feed rolls.	Increase pressure setting on wire feed rolls.
	Incorrect wire feed rolls.	Check size stamped on wire feed rolls, replace to match wire size and type if necessary.
	Wire spool brake pressure too high.	Decrease brake pressure on wire spool.
	Restriction in the gun and/or assembly.	Check and replace cable, gun, and contact tip if damaged. Check size of contact tip and cable liner, replace if necessary.
Wire curling up in front of the wire feed rolls (bird nesting).	Too much pressure on wire feed rolls.	Decrease pressure setting on wire feed rolls.
	Incorrect cable liner or gun contact tip size.	Check size of contact tip and check cable liner length and diameter, replace if necessary.
	Gun end not inserted into drive housing properly.	Loosen gun securing bolt in drive housing and push gun end into housing just enough so it does not touch wire feed rolls.
	Dirty or damaged (kinked) liner.	Replace liner.
Wire feeds, but no gas flows.	Gas cylinder empty.	Replace empty gas cylinder.
	Gas nozzle plugged.	Clean or replace gas nozzle.
	Gas cylinder valve not open or flowmeter not adjusted.	Open gas valve at cylinder and adjust flow rate.
	Restriction in gas line.	Check gas hose between flowmeter and wire feeder, and gas hose in gun and cable assembly.
	Loose or broken wires to gas solenoid.	Have Factory Authorized Service Agent repair wiring.
	Gas solenoid valve not operating.	Have Factory Authorized Service Agent replace gas solenoid valve.
	Incorrect primary voltage connected to welding power source.	Check primary voltage and relink welding power source for correct voltage.

Problem	Probable Cause	Remedy
Welding arc not stable.	Wire slipping in drive rolls.	Adjust pressure setting on wire feed rolls. Replace worn drive rolls if necessary.
	Wrong size gun liner or contact tip.	Match liner and contact tip to wire size and type.
	Incorrect voltage setting for selected wire feed speed on welding power source.	Readjust welding parameters.
	Loose connections at the gun weld cable or work cable.	Check and tighten all connections.
	Gun in poor shape or loose connection inside gun.	Repair or replace gun as necessary.

SECTION 9 – STICK WELDING (SMAW) GUIDELINES

9-1. Stick Welding Procedure



Tools Needed:

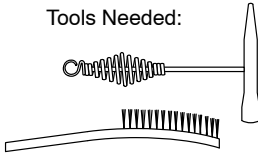

Equipment Needed:

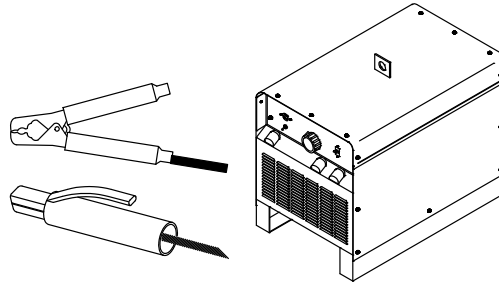

Constant Current
Welding Power Source

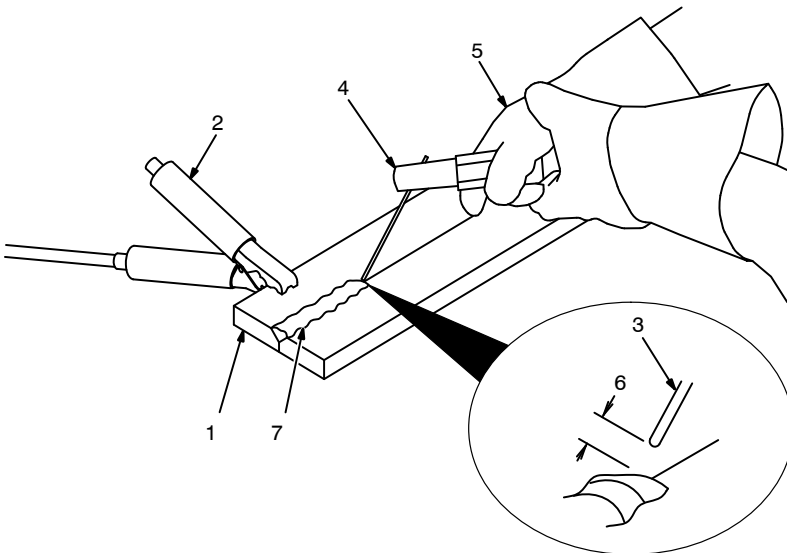

⚠ Weld current starts when electrode touches work-piece.

⚠ Weld current can damage electronic parts in vehicles. Disconnect both battery cables before welding on a vehicle. Place work clamp as close to the weld as possible.

☞ Always wear appropriate personal protective clothing.

1 Workpiece

Make sure workpiece is clean before welding.

2 Work Clamp

3 Electrode

A small diameter electrode requires less current than a large one. Follow electrode manufacturer's instructions when setting weld amperage (see Section 9-2).

4 Insulated Electrode Holder

5 Electrode Holder Position

6 Arc Length

Arc length is the distance from the electrode to the workpiece. A short arc with correct amperage will give a sharp, crackling sound.

7 Slag

Use a chipping hammer and wire brush to remove slag. Remove slag and check weld bead before making another weld pass.

9-2. Electrode and Amperage Selection Chart

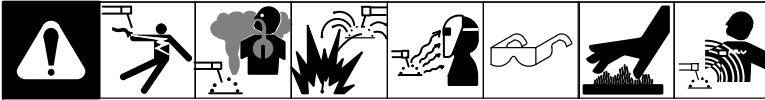

ELECTRODE	DIAMETER	AMPERAGE RANGE								
		50	100	150	200	250	300	350	400	450
6010 & 6011	3/32									
	1/8									
	5/32									
	3/16									
	7/32									
6013	1/4									
	1/16									
	5/64									
	3/32									
	1/8									
7014	5/32									
	3/16									
	7/32									
	1/4									
	3/32									
7018	1/8									
	5/32									
	3/16									
	7/32									
	1/4									
7024	3/32									
	1/8									
	5/32									
	3/16									
	7/32									
Ni-CI	1/4									
	3/32									
	1/8									
308L	5/32									
	1/8									
	3/32									

ELECTRODE	DC*	AC	POSITION	PENETRATION	USAGE
6010	EP		ALL	DEEP	MIN. PREP, ROUGH HIGH SPATTER
6011	EP	✓	ALL	DEEP	
6013	EP,EN	✓	ALL	LOW	GENERAL
7014	EP,EN	✓	ALL	MED	SMOOTH, EASY, FAST
7018	EP	✓	ALL	MED	LOW HYDROGEN, STRONG
7024	EP,EN	✓	FLAT HORIZ FILLET	LOW	SMOOTH, EASY, FASTER
NI-CL	EP	✓	ALL	LOW	CAST IRON
308L	EP	✓	ALL	LOW	STAINLESS

*EP = ELECTRODE POSITIVE (REVERSE POLARITY)
EN = ELECTRODE NEGATIVE (STRAIGHT POLARITY)

Ref. S-087 985-A

9-3. Striking an Arc

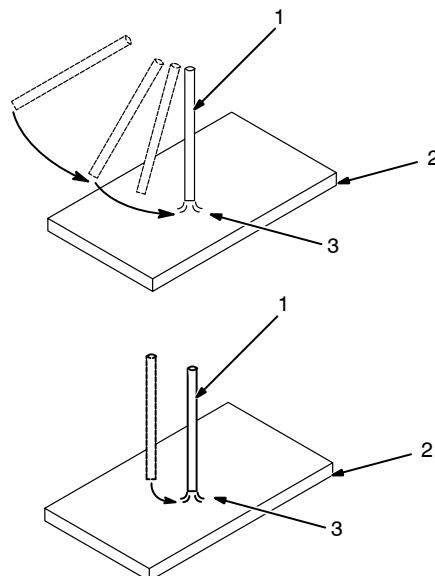

- 1 Electrode
- 2 Workpiece
- 3 Arc

Scratch Technique

Drag electrode across workpiece like striking a match; lift electrode slightly after touching work. If arc goes out, electrode was lifted too high. If electrode sticks to workpiece, use a quick twist to free it.

Tapping Technique

Bring electrode straight down to workpiece; then lift slightly to start arc. If arc goes out, electrode was lifted too high. If electrode sticks to workpiece, use a quick twist to free it.

S-0049 / S-0050

9-4. Positioning Electrode Holder



- 1 End View Of Work Angle
- 2 Side View Of Electrode Angle

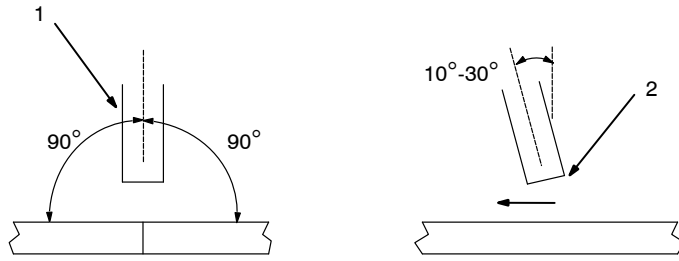

Groove Welds

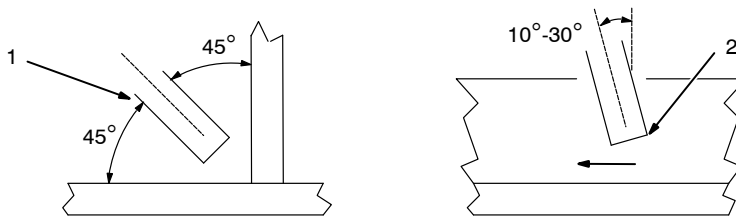

Fillet Welds

S-0060

9-5. Poor Weld Bead Characteristics

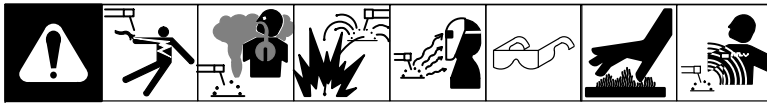

- 1 Large Spatter Deposits
- 2 Rough, Uneven Bead
- 3 Slight Crater During Welding
- 4 Bad Overlap
- 5 Poor Penetration

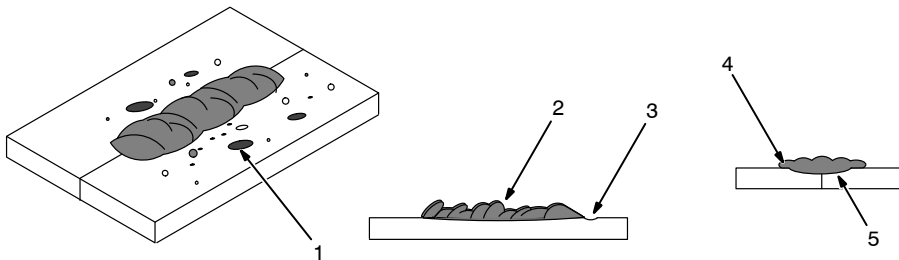

S-0053-A

9-6. Good Weld Bead Characteristics

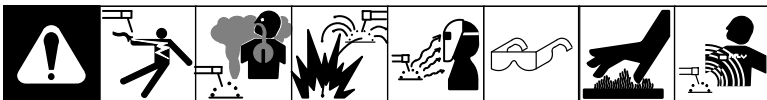

- 1 Fine Spatter
- 2 Uniform Bead
- 3 Moderate Crater During Welding

Weld a new bead or layer for each 1/8 in. (3.2 mm) thickness in metals being welded.

- 4 No Overlap
- 5 Good Penetration into Base Metal

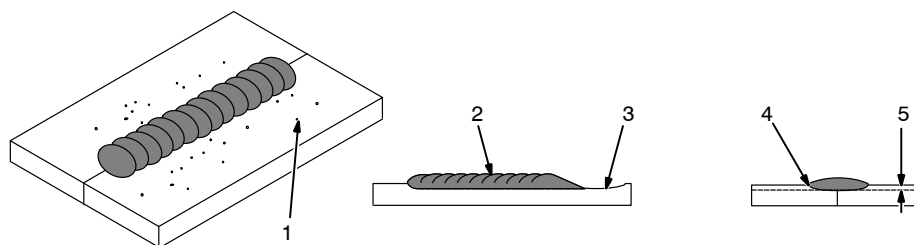

S-0052-B

9-7. Conditions That Affect Weld Bead Shape



Weld bead shape is affected by electrode angle, arc length, travel speed, and thickness of base metal.

Condition	Too Small / Too Short / Slow	Correct / Normal	Too Large / Too Long / Fast
Electrode Angle	Angle Too Small Weld bead is narrow and flat.	Correct Angle 10° - 30° Weld bead is smooth and rounded.	Angle Too Large Weld bead is wide and flat.
Arc Length	Too Short Weld bead is narrow and flat.	Normal Weld bead is smooth and rounded.	Too Long Weld bead is wide and flat with spatter.
Travel Speed	Slow Weld bead is wide and flat.	Normal Weld bead is smooth and rounded.	Fast Weld bead is narrow and flat.

S-0061

9-8. Electrode Movement During Welding



Normally, a single stringer bead is satisfactory for most narrow groove weld joints; however, for wide groove weld joints or bridging across gaps, a weave bead or multiple stringer beads work better.

- Stringer Bead – Steady Movement Along Seam
- Weave Bead – Side to Side Movement Along Seam
- Weave Patterns

Use weave patterns to cover a wide area in one pass of the electrode. Do not let weave width exceed 2-1/2 times diameter of electrode.

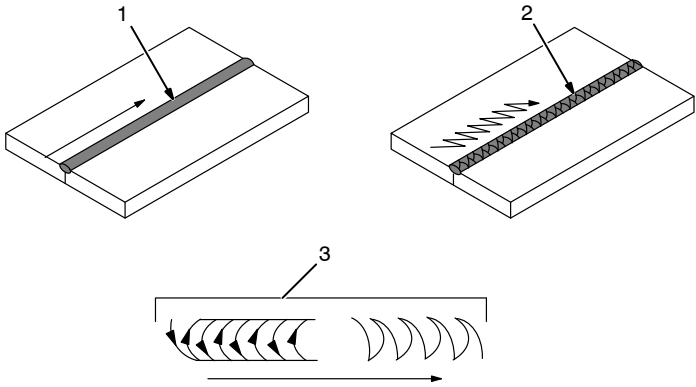

S-0054-A

9-9. Groove (Butt) Joints

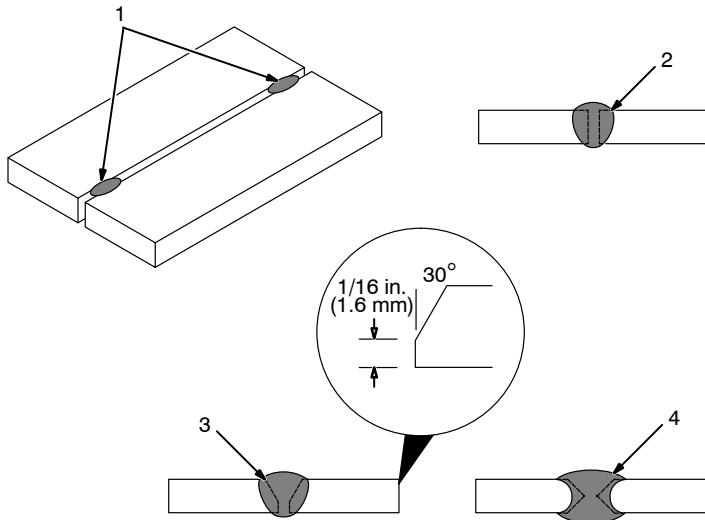

1 Tack Welds

Prevent edges of joint from drawing together ahead of electrode by tack welding the materials in position before final weld.

2 Square Groove Weld

Good for materials up to 3/16 in. (5 mm) thick.

3 Single V-Groove Weld

Good for materials 3/16 – 3/4 in. (5-19 mm) thick. Cut bevel with oxyacetylene or plasma cutting equipment. Remove scale from material after cutting. A grinder can also be used to prepare bevels.

Create 30 degree angle of bevel on materials in V-groove welding.

4 Double V-Groove Weld

Good for materials thicker than 3/16 in. (5 mm).

S-0062

9-10. Lap Joint

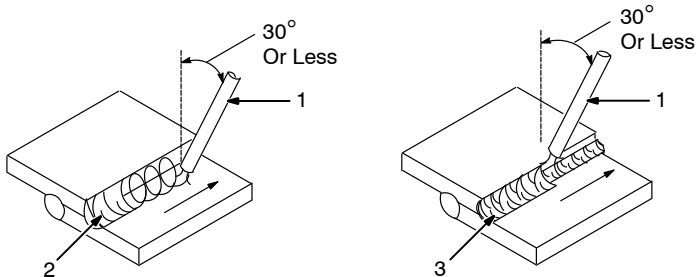

1 Electrode

2 Single-Layer Fillet Weld

Move electrode in circular motion.

3 Multi-Layer Fillet Weld

Weld a second layer when a heavier fillet is needed. Remove slag before making another weld pass. Weld both sides of joint for maximum strength.

S-0063 / S-0064

9-11. Tee Joint

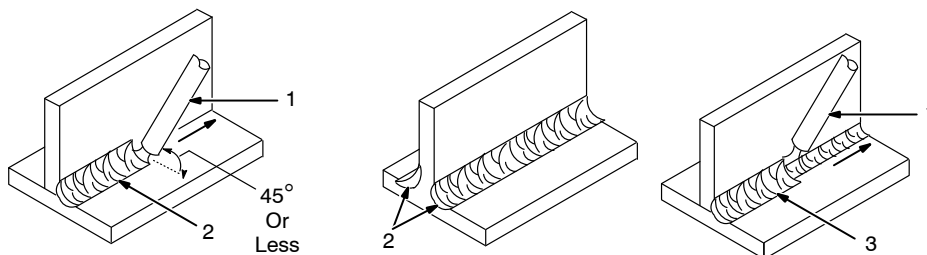

1 Electrode

2 Fillet Weld

Keep arc short and move at definite rate of speed. Hold electrode as shown to provide fusion into the corner. Square edge of the weld surface.

For maximum strength weld both sides of upright section.

3 Multi-Layer Deposits

Weld a second layer when a heavier fillet is needed. Use any of the weaving patterns shown in Section 9-8. Remove slag before making another weld pass.

S-0060 / S-0058-A / S-0061

9-12. Weld Test



- 1 Vise
- 2 Weld Joint
- 3 Hammer

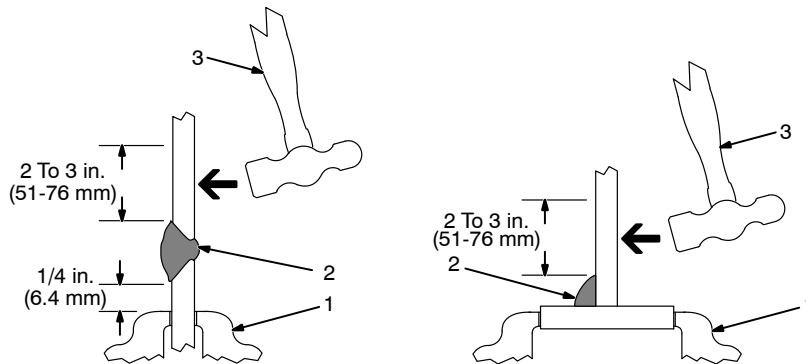

Strike weld joint in direction shown. A good weld bends over but does not break.

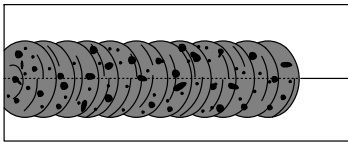
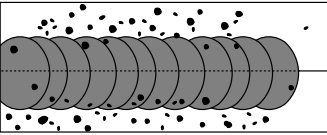
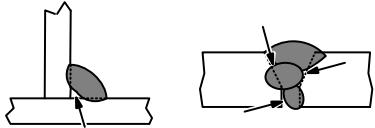

S-0057-B

9-13. Troubleshooting

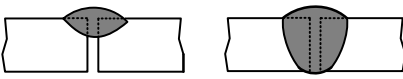
	<p>Porosity – small cavities or holes resulting from gas pockets in weld metal.</p>
<p>Possible Causes</p>	<p>Corrective Actions</p>
<p>Arc length too long.</p>	<p>Reduce arc length.</p>
<p>Damp electrode.</p>	<p>Use dry electrode.</p>
<p>Workpiece dirty.</p>	<p>Remove all grease, oil, moisture, rust, paint, coatings, slag, and dirt from work surface before welding.</p>
	<p>Excessive Spatter – scattering of molten metal particles that cool to solid form near weld bead.</p>
<p>Possible Causes</p>	<p>Corrective Actions</p>
<p>Amperage too high for electrode.</p>	<p>Decrease amperage or select larger electrode.</p>
<p>Arc length too long or voltage too high.</p>	<p>Reduce arc length or voltage.</p>
	<p>Incomplete Fusion – failure of weld metal to fuse completely with base metal or a preceding weld bead.</p>
<p>Possible Causes</p>	<p>Corrective Actions</p>
<p>Insufficient heat input.</p>	<p>Increase amperage. Select larger electrode and increase amperage.</p>
<p>Improper welding technique.</p>	<p>Place stringer bead in proper location(s) at joint during welding.</p> <p>Adjust work angle or widen groove to access bottom during welding.</p> <p>Momentarily hold arc on groove side walls when using weaving technique.</p> <p>Keep arc on leading edge of weld puddle.</p>
<p>Workpiece dirty.</p>	<p>Remove all grease, oil, moisture, rust, paint, coatings, slag, and dirt from work surface before welding.</p>

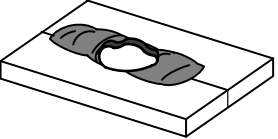
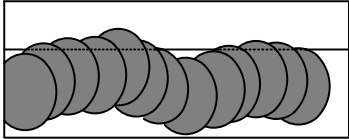
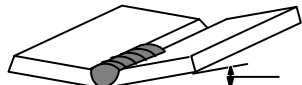
 <p>Lack of Penetration Good Penetration</p>	<p>Lack Of Penetration – shallow fusion between weld metal and base metal.</p>
<p>Possible Causes</p>	<p>Corrective Actions</p>
<p>Improper joint preparation.</p>	<p>Material too thick. Joint preparation and design must provide access to bottom of groove.</p>
<p>Improper weld technique.</p>	<p>Keep arc on leading edge of weld puddle.</p>
<p>Insufficient heat input.</p>	<p>Increase amperage. Select larger electrode and increase amperage.</p>
	<p>Reduce travel speed.</p>
 <p>Excessive Penetration Good Penetration</p>	<p>Excessive Penetration – weld metal melting through base metal and hanging underneath weld.</p>
<p>Possible Causes</p>	<p>Corrective Actions</p>
<p>Excessive heat input.</p>	<p>Select lower amperage. Use smaller electrode.</p>
	<p>Increase and/or maintain steady travel speed.</p>
	<p>Burn-Through – weld metal melting completely through base metal resulting in holes where no metal remains.</p>
<p>Possible Causes</p>	<p>Corrective Actions</p>
<p>Excessive heat input.</p>	<p>Select lower amperage. Use smaller electrode.</p>
	<p>Increase and/or maintain steady travel speed.</p>
	<p>Waviness Of Bead – weld metal that is not parallel and does not cover joint formed by base metal.</p>
<p>Possible Causes</p>	<p>Corrective Actions</p>
<p>Unsteady hand.</p>	<p>Use two hands. Practice technique.</p>
 <p>Base metal moves in the direction of the weld bead.</p>	<p>Distortion – contraction of weld metal during welding that forces base metal to move.</p>
<p>Possible Causes</p>	<p>Corrective Actions</p>
<p>Excessive heat input.</p>	<p>Use restraint (clamp) to hold base metal in position.</p>
	<p>Make tack welds along joint before starting welding operation.</p>
	<p>Select lower amperage for electrode.</p>
	<p>Increase travel speed.</p>
	<p>Weld in small segments and allow cooling between welds.</p>

SECTION 10 – SELECTING AND PREPARING A TUNGSTEN FOR DC OR AC WELDING WITH INVERTER MACHINES

gtaw_Inverter_2011-06



Whenever possible and practical, use DC weld output instead of AC weld output.

10-1. Selecting Tungsten Electrode (Wear Clean Gloves To Prevent Contamination Of Tungsten)

☞ Not all tungsten electrode manufacturers use the same colors to identify tungsten type. Contact the tungsten electrode manufacturer or reference the product packaging to identify the tungsten you are using.

Electrode Diameter	Amperage Range - Gas Type♦ - Polarity	
	(DCEN) – Argon Direct Current Electrode Negative (For Use With Mild Or Stainless Steel)	AC – Argon Balance Control @ 65% Electrode Negative (For Use With Aluminum)
2% Ceria, 1.5% Lanthanum, Or 2% Thorium Alloy Tungstens		
.010 in. (1 mm)	Up to 25	Up to 20
.020 in. (1 mm)	15-40	15-35
.040 in. (1 mm)	25-85	20-80
1/16 in. (1.6 mm)	50-160	50-150
3/32 in. (2.4 mm)	130-250	135-235
1/8 in. (3.2 mm)	250-400	225-360
5/32 in. (4.0 mm)	400-500	300-450
3/16 in (4.8 mm)	500-750	400-500
1/4 in. (6.4 mm)	750-1000	600-800

♦ Typical argon shielding gas flow rates are 11 to 35 CFH (cubic feet per hour).

Figures listed are a guide and are a composite of recommendations from American Welding Society (AWS) and electrode manufacturers.

10-2. Preparing Tungsten Electrode For DC Electrode Negative (DCEN) Welding Or AC Welding With Inverter Machines



Grinding the tungsten electrode produces dust and flying sparks which can cause injury and start fires. Use local exhaust (forced ventilation) at the grinder or wear an approved respirator. Read MSDS for safety information. Consider using tungsten containing ceria, lanthana, or yttria instead of thoria. Grinding dust from thoriated electrodes contains low-level radioactive material. Properly dispose of grinder dust in an environmentally safe way. Wear proper face, hand, and body protection. Keep flammables away.

- 1 Grinding Wheel
Grind end of tungsten on fine grit, hard abrasive wheel before welding. Do not use wheel for other jobs or tungsten can become contaminated causing lower weld quality.
- 2 Tungsten Electrode
A 2% ceriated tungsten is recommended.
- 3 Flat
Diameter of this flat determines amperage capacity.
- 4 Straight Ground
Grind lengthwise, **not radial**.

SECTION 11 – GUIDELINES FOR TIG WELDING (GTAW)

11-1. Positioning The Torch

The diagram illustrates the correct positioning of a TIG welding torch. The main illustration shows a hand holding the torch (3) against a workpiece (1) held in a work clamp (2). A filler rod (4) is being fed into the torch. A 90-degree angle is indicated between the torch and the workpiece. A gas cup (5) is shown at the tip of the torch, containing a tungsten electrode (6). A circular inset provides a detailed view of the gas cup assembly. It shows the tungsten electrode (6) extending into the gas cup (5). The angle between the tungsten electrode and the workpiece is labeled as 10-15 degrees. The angle between the filler rod (4) and the workpiece is labeled as 10-25 degrees. The bottom view of the gas cup shows a diameter of 3/16 in. and a tungsten diameter of 1/16 in.

⚠ Grinding the tungsten electrode produces dust and flying sparks which can cause injury and start fires. Use local exhaust (forced ventilation) at the grinder or wear an approved respirator. Read MSDS for safety information. Consider using cerium or lanthanum based tungsten instead of thoriated. Thorium dust contains low-level radioactive material. Properly dispose of grinder dust in an environmentally safe way. Wear proper face, hand, and body protection. Keep flammables away.

- 1 Workpiece
Make sure workpiece is clean before welding.
- 2 Work Clamp
Place as close to the weld as possible.
- 3 Torch
- 4 Filler Rod (If Applicable)
- 5 Gas Cup
- 6 Tungsten Electrode

Select and prepare tungsten according to Section 10.

Guidelines:

The inside diameter of the gas cup should be at least three times the tungsten diameter to provide adequate shielding gas coverage. (For example, if tungsten is 1/16 in. diameter, gas cup should be a minimum of 3/16 in. diameter.)

Tungsten extension is the distance the tungsten extends out gas cup of torch.

The tungsten extension should be no greater than the inside diameter of the gas cup.

Arc length is the distance from the tungsten to the workpiece.

Bottom View Of Gas Cup

Ref. ST-161 892

11-2. Torch Movement During Welding

Tungsten Without Filler Rod

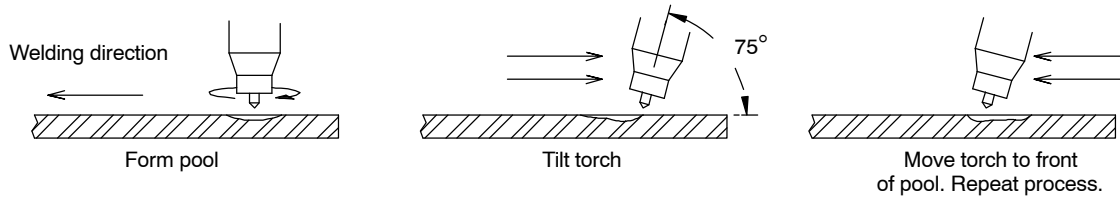

Tungsten With Filler Rod

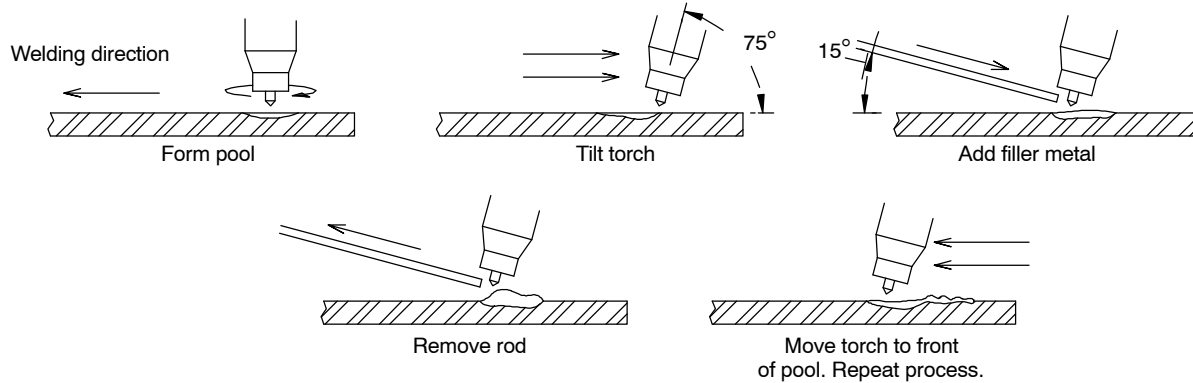

ST-162 002-B

11-3. Positioning Torch Tungsten For Various Weld Joints

Butt Weld And Stringer Bead

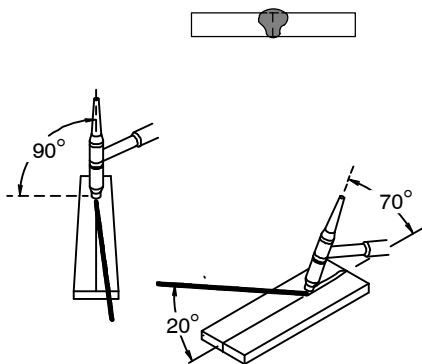

"T" Joint

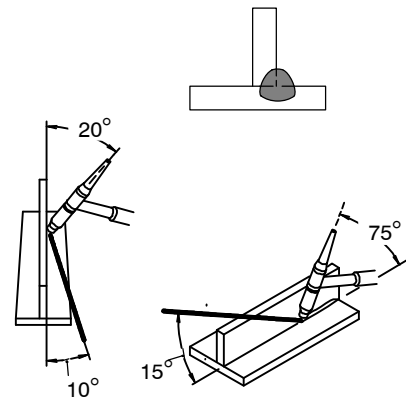

Lap Joint

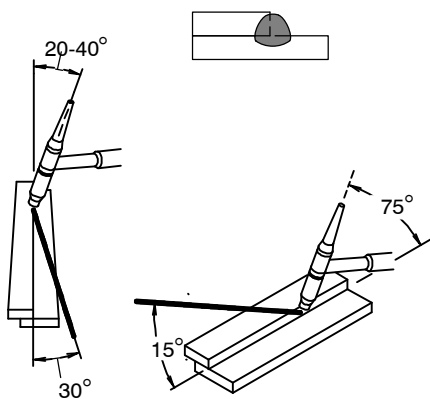

Corner Joint

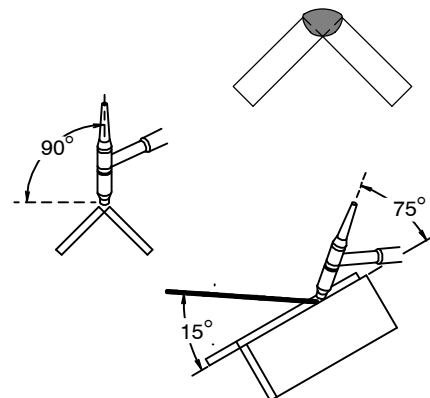

ST-162 003 / S-0792

SECTION 12 – PARTS LIST

 Hardware is common and not available unless listed.

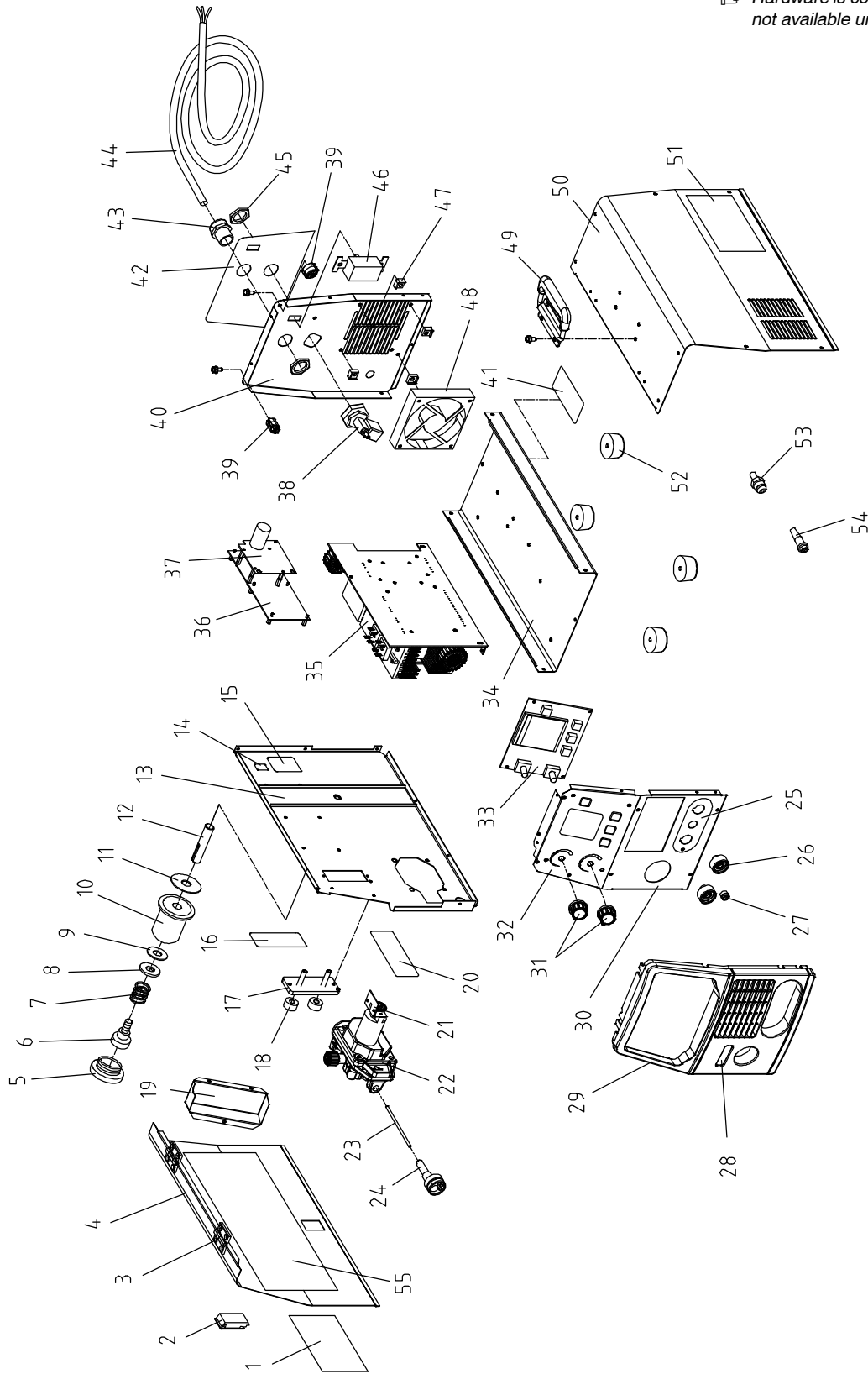

Figure 12-1. Main Assembly

Item No.	Dia. Mkgs.	Part No.	Description	Quantity
----------	------------	----------	-------------	----------

Figure 12-1. Main Assembly

...	1	000207233	Label, General Precautionary	1	
...	2	156034005	Slide Clip	1	
...	3	156034007	Hinge, Plastic, 40x40	2	
...	4	+156007044	Panel, LH	1	
...	5	+156015030	Threaded Ring, Spool Holder, 5kg Spool	1	
...	6	056020078	Handwheel, Reel, w/Ring M8x20	1	
...	7	156032137	Spring 17x2, 6x4sp.L=19	1	
...	8	156009146	Clamp, Holder 17x41 – 4mm Thick	1	
...	9	656009005	Disk Clutch, 20x42 For Holder 5kg	1	
...	10	656102008	Spool Holder c/w Ring 5kg Spool	1	
...	11	556009032	Brass Washer, 8,5x51,5 – 0,7mm Thick	1	
...	12	156012153	Spool Holder Shaft d.50 5kg d.16 L=58	1	
...	13	+156122090	Plate, Baffle	1	
...	14	000155436	Label, Ground	1	
...	15	000176106	Label, Moving Parts	1	
...	16	956142877	Label, Warning Changing Polarity	1	
...	17	756069036	Kit, Gas/No Gas Change Board	1	
...	18	056020079	4 Lobes d.30 Handwheel	2	
...	19	116039031	Box Protection, PCB	1	
...	20	000178937	Label, Warning Electric Shock	1	
...	21	PC5	057084174	Circuit Card, Encoder	1
...	22	057021025	Wire Drive System, c/w 0.8–1.0 Rolls, 4 Rolls (see Fig.)	1	
...	23	556090045	Wire Guide, 2x5, L69, Outlet	1	
...	24	057052052	Connector, Mini-Euro, Quick Female, L17	1	
...	25	356029245	Nameplate, MPi 220 Lower	2	
...	26	056076270	Dinse, Socket, Female, 25MMQ	1	
...	27	056076271	Receptacle, 2P, Gun Trigger	1	
...	28	956142876	Nameplate, Mpi 220P	1	
...	29	156118081	Bezel, Front	1	
...	30	156118079	Panel, Front	1	
...	31	193919	Knob, Pointer	2	
...	32	356029244	Nameplate, Mpi 220 Upper	1	
...	33	PC3	057084175	Circuit Card, Meter	1
...	34	156006072	Base	1	
...	35	PC2	028069126	Circuit Card, Power Interconnecting	1
...	36	PC1	057084176	Circuit Card, Inverter Control	1
...	37	PC4	057084177	Circuit Card, Motor Control	1
...	38	GSV	056061071	Valve, Gas	1
...	39	156005146	Corner Seal, Plastic	2	
...	40	+156118080	Panel, Rear	1	
...	41	956142878	Rating Plate, Mpi 220P	1	
...	42	356029246	Nameplate, Rear, Mpi 220P	1	
...	43	656089046	Strain Relief, M 25x1.5, Primary Cord	1	
...	44	256071014	Primary Cable, 3 Core 2,5 Mq	1	
...	45	000220805	Nut, Gas Valve	1	
...	46	S1	056067281	Switch, 40A 600VAC	1
...	47	156008044	Spacer, Fan	4	
...	48	057035022	Fan, 120x120 24VDC c/w Wire Harness	1	
...	49	000195585	Handle	1	
...	50	+156122091	Panel RH	1	
...	51	000207291	Label, Primary Power Connections	1	
...	52	656110015	Foot, Rubber Mount, D.45 H=25	4	
...	53	057052053	Hose, Connector, 3/8"	1	
...	54	256124039	Plug, 2P, TIG	1	
...	55	956142897	Label, Weld Parameters Chart	1	

+ When ordering a component originally displaying a precautionary label, the label should also be ordered.

To maintain the factory original performance of your equipment, use only Manufacturer's Suggested Replacement Parts. Model and serial number required when ordering parts from your local distributor.

 Hardware is common and not available unless listed.

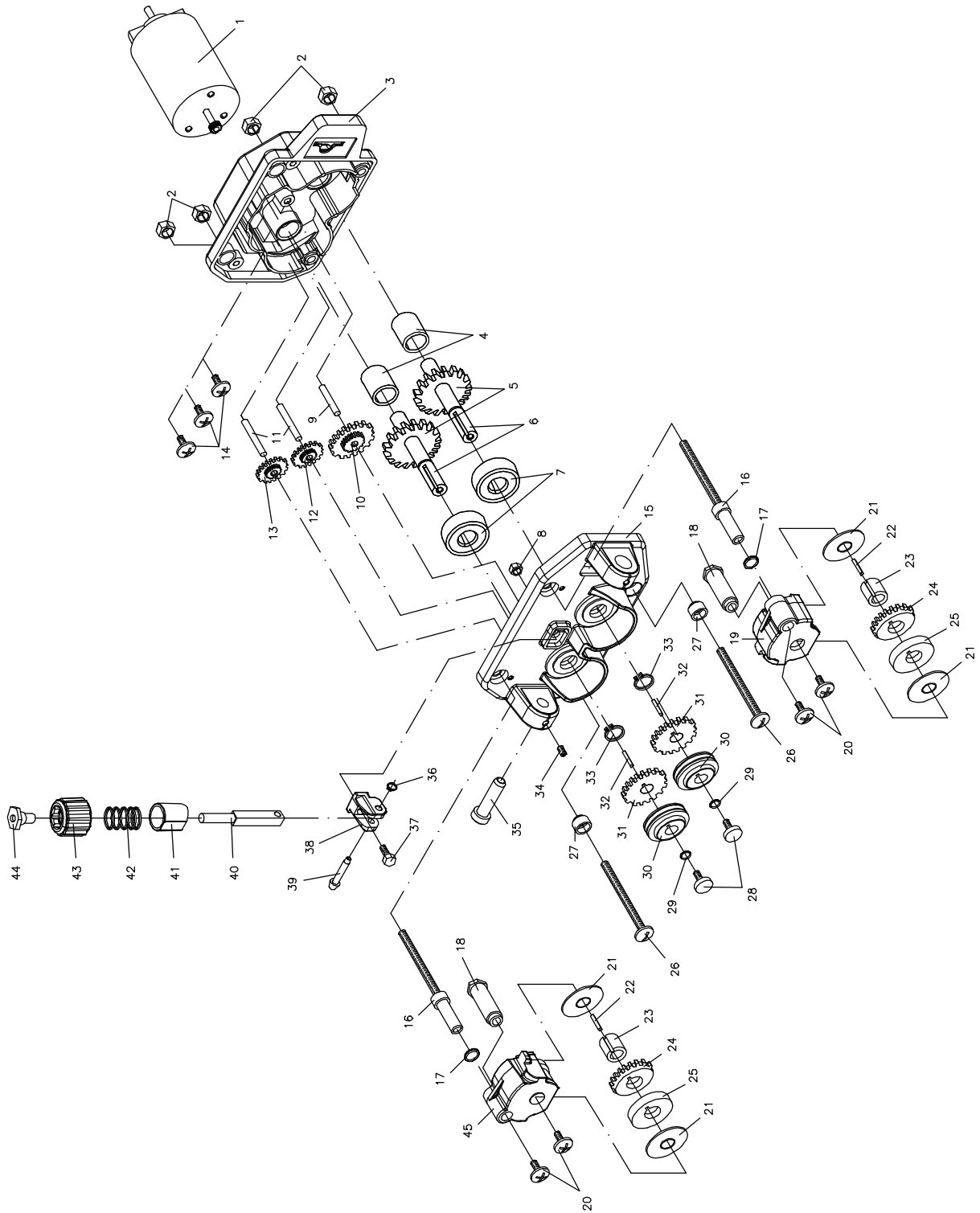

Figure 12-2. Wire Drive Assembly

Item No.	Dia. Mkgs.	Part No.	Description	Quantity
----------	------------	----------	-------------	----------

Figure 12-2. Wire Drive Assembly

...	1	M	056126081	Motor, Gear	1
...	2		156018121	Nut, Hex M5, Steel	4
...	3		556075033	Cover, Rear, Gear Box Assembly	1
...	4		156033035	Bushing, d.10x14, Brass	2
...	5		656003014	Drive Shaft, Central Gear/Drive Roll	2
...	6		156012154	Snap Ring, TR.PL AL ES.12 L=54	2
...	7		156017161	Bearing, d.10x26	2
...	8		156018126	Nut, Hex M4	1
...	9		156012142	Pin, d.4x25 SM.0,3x45Ø C40 RETT	1
...	10		156003035	Gear, Reducer, D32Z30 D17Z12	1
...	11		156012140	Pin, d.4x35 SM.0,3x45Ø C40 RETT	2
...	12		156003034	Gear, Reducer, D24Z30 D14Z12	1
...	13		156003039	Gear, Reducer, D23Z38 D12Z14	1
...	14		156019776	Screw, M4x10, Zinc Steel	3
...	15		356052009	Housing, Adapter Gun/Feeder	1
...	16		156012155	Housing, Adapter Gun/Feeder	2
...	17		156023172	O-Ring, 10x16x0,2 DIN 988	2
...	18		156012145	Pin, Drive Roll	2
...	19		356052010	Upper RH Pressure Arm Housing, Die Cast	1
...	20		156019777	Screw, M4x8, Pan Head	4
...	21		156009136	Washer, d.10,5x4, Brass	4
...	22		156013050	Key, Upper Drive Roll Assembly, 3x3 L=15	2
...	23		156033036	Bushing, Upper Drive Roll Assembly	2
...	24		156003036	Gear, Upper Drive Roll Assembly, d.17x32.5	2
...	25		156053112	Drive Roll, Upper Pressure Arm Housing, d.17x30	2
...	26		156019805	Bolt, M5x25, Through Housing	2
...	27		756009061	Washer, Insulator Drive Assembly Through Bolt	2
...	28		656033010	Thumb Screw, Drive Roll Locator, d. M4x8	2
...	29		656021268	O-Ring, d.7,2x1,78	2
...	30		156053109	Wire Drive Roll, d.30, See Figure 12-2 and Table 12-1	2
...	31		156003037	Gear, Lower Drive Roll Assembly d.10x32,5, Drive Roll	2
...	32		156013051	Key, Lower Drive Roll Assembly d. 3x3 L=20	2
...	33		156023165	C-Clip, Gear/Shaft, d.10	2
...	34		156019779	Screw, M4x4, Wire Inlet	1
...	35		156090026	Wire Inlet Guide, See Figure 12-2 and Table 12-1	1
...	36		156023173	C-Clip, Tension Arm, d.5	1
...	37		156019806	Screw, M4 Steel	1
...	38		356052011	Bracket, Tension Arm Support	1
...	39		156090027	Pin, d.4	1
...	40		656064004	Tension Arm, Pinned	1
...	41		156032138	Sleeve, d.7x7 Spring Housing	1
...	42		156032134	Spring, 10x1.3 L 30, Wire Tensioning	1
...	43		056020075	Knob, Adjustment Tension	1
...	44		656033009	Nut, Locating, Tension Knob	1
...	45		356052012	Upper LH Pressure Arm Housing, Die Cast	1

To maintain the factory original performance of your equipment, use only Manufacturer's Suggested Replacement Parts. Model and serial number required when ordering parts from your local distributor.

Table 12-1. Drive Roll And Wire Guide Kits

 Base selection of drive rolls upon the following recommended usages:

1. V-Grooved rolls for hard wire.
2. U-Grooved rolls for soft and soft shelled cored wires.
3. V-Knurled rolls for hard shelled cored wires.
4. Drive roll types may be mixed to suit particular requirements (example: V-Knurled roll in combination with U-Grooved).

Wire Diameter			Drive Roll		Wire Guide
Metric	Fraction	Decimal	Part No.	Type	Inlet
0.6/0.8 mm*	0.023/0.030 in.	0.023/0.030 in.	156053051	V	156090026
0.8/1.0 mm*	0.030/0.035 in.	0.030/0.035 in.	156053109	V	
1.0/1.2 mm*	0.035/0.045 in.	0.035/0.045 in.	156053052	V	
0.8/1.0 mm*	0.030/0.045 in.	0.030/0.035 in.	156053053	U	
1.2/1.6 mm*	0.045/0.065 in.	0.035/0.065 in.	156053054	U	
1.0/1.2 mm*	0.035/0.045 in.	0.035/0.045 in.	156053110	V-K	

*Available in steel 30 mm diameter
 **Available in nylon 30 mm diameter

Notes

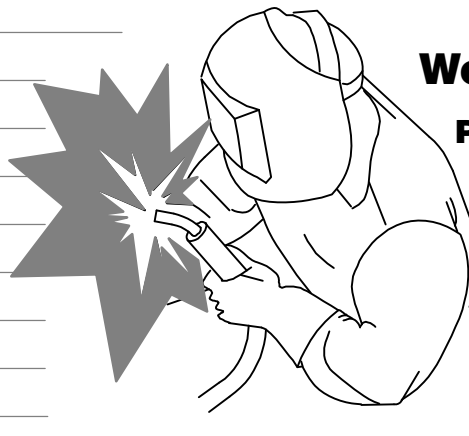

Work like a Pro!
Pros weld and cut safely. Read the safety rules at the beginning of this manual.

TRUE BLUE[®]

WARRANTY

Effective January 1, 2012
(Equipment with a serial number preface of MC or newer)

This limited warranty supersedes all previous Miller warranties and is exclusive with no other guarantees or warranties expressed or implied.

LIMITED WARRANTY – Subject to the terms and conditions below, ITW Welding Products Italy warrants to its original retail purchaser that new Miller equipment sold after the effective date of this limited warranty is free of defects in material and workmanship at the time it is shipped by Miller. THIS WARRANTY IS EXPRESSLY IN LIEU OF ALL OTHER WARRANTIES, EXPRESS OR IMPLIED, INCLUDING THE WARRANTIES OF MERCHANTABILITY AND FITNESS.

Within the warranty periods listed below, Miller will repair or replace any warranted parts or components that fail due to such defects in material or workmanship. Miller must be notified in writing within thirty (30) days of such defect or failure, at which time Miller will provide instructions on the warranty claim procedures to be followed.

Miller shall honor warranty claims on warranted equipment listed below in the event of such a failure within the warranty time periods. All warranty time periods start on the date the equipment was delivered to the original retail purchaser or one year after the equipment is shipped to a European distributor or eighteen months after the equipment is shipped to an International distributor.

1. 5 Years Parts — 3 Years Labor
 - * Original main power rectifiers only to include SCRs, diodes, and discrete rectifier modules with exclusion of STR, Si, STI, STH and MPi series.
2. 3 Years — Parts and Labor
 - * Engine Driven Welding Generators
(NOTE: Engines are warranted separately by the engine manufacturer.)
 - * Inverter Power Sources (Unless Otherwise Stated)
 - * Process Controllers
 - * Semi-Automatic and Automatic Wire Feeders
 - * Transformer/Rectifier Power Sources
 - * Water Coolant System (Integrated)
3. 2 Years — Parts
 - * Auto-Darkening Helmet Lenses (No Labor)
 - * Migmatic 175
 - * HF Units
 - * Water Coolant Systems (EU Models, Non-Integrated)
4. 1 Year — Parts and Labor Unless Specified
 - * Automatic Motion Devices
 - * Field Options
(NOTE: Field options are covered under True Blue[®] for the remaining warranty period of the product they are installed in, or for a minimum of one year — whichever is greater.)
 - * Induction Heating Power Sources, Coolers, and Electronic Controls/Recorders
 - * Motor Driven Guns (w/exception of Spoolmate Spoolguns)
 - * Positioners and Controllers
 - * Powered Air Purifying Respirator (PAPR) Blower Unit (No Labor)
 - * Racks
 - * Running Gear and Trailers
 - * Subarc Wire Drive Assemblies
 - * Water Coolant Systems (USA Models, Non-Integrated)
 - * Work Stations/Weld Tables (No Labor)
5. 6 Months — Parts
 - * Batteries

6. 90 Days — Parts
 - * Accessory (Kits)
 - * Canvas Covers
 - * Induction Heating Coils and Blankets
 - * MIG Guns
 - * Remote Controls
 - * Replacement Parts (No Labor)
 - * Spoolmate Spoolguns
 - * Cables and Non-Electronic Controls

Miller's True Blue[®] Limited Warranty shall not apply to:

1. **Consumable components; such as contact tips, cutting nozzles, contactors, brushes, switches, slip rings, relays or parts that fail due to normal wear.**
2. Items furnished by Miller, but manufactured by others, such as engines or trade accessories. These items are covered by the manufacturer's warranty, if any.
3. Equipment that has been modified by any party other than Miller, or equipment that has been improperly installed, improperly operated or misused based upon industry standards, or equipment which has not had reasonable and necessary maintenance, or equipment which has been used for operation outside of the specifications for the equipment.

MILLER PRODUCTS ARE INTENDED FOR PURCHASE AND USE BY COMMERCIAL/INDUSTRIAL USERS AND PERSONS TRAINED AND EXPERIENCED IN THE USE AND MAINTENANCE OF WELDING EQUIPMENT.

In the event of a warranty claim covered by this warranty, the exclusive remedies shall be, at Miller's option: (1) repair; or (2) replacement; or, where authorized in writing by Miller in appropriate cases, (3) the reasonable cost of repair or replacement at an authorized Miller service station; or (4) payment of or credit for the purchase price (less reasonable depreciation based upon actual use) upon return of the goods at customer's risk and expense. Miller's option of repair or replacement will be F.O.B., Factory at ITW Welding Products Group Europe or F.O.B. at a Miller authorized service facility as determined by Miller. Therefore no compensation or reimbursement for transportation costs of any kind will be allowed.

TO THE EXTENT PERMITTED BY LAW, THE REMEDIES PROVIDED HEREIN ARE THE SOLE AND EXCLUSIVE REMEDIES. IN NO EVENT SHALL MILLER BE LIABLE FOR DIRECT, INDIRECT, SPECIAL, INCIDENTAL OR CONSEQUENTIAL DAMAGES (INCLUDING LOSS OF PROFIT), WHETHER BASED ON CONTRACT, TORT OR ANY OTHER LEGAL THEORY.

ANY EXPRESS WARRANTY NOT PROVIDED HEREIN AND ANY IMPLIED WARRANTY, GUARANTY OR REPRESENTATION AS TO PERFORMANCE, AND ANY REMEDY FOR BREACH OF CONTRACT TORT OR ANY OTHER LEGAL THEORY WHICH, BUT FOR THIS PROVISION, MIGHT ARISE BY IMPLICATION, OPERATION OF LAW, CUSTOM OF TRADE OR COURSE OF DEALING, INCLUDING ANY IMPLIED WARRANTY OF MERCHANTABILITY OR FITNESS FOR PARTICULAR PURPOSE, WITH RESPECT TO ANY AND ALL EQUIPMENT FURNISHED BY MILLER IS EXCLUDED AND DISCLAIMED BY MILLER.





Owner's Record

Please complete and retain with your personal records.

Model Name

Serial/Style Number

Purchase Date

(Date which equipment was delivered to original customer.)

Distributor

Address

Country

Zip/Postal Code



For Service

Contact a *DISTRIBUTOR* or *SERVICE AGENCY* near you.

Always provide Model Name and Serial/Style Number.

Contact your Distributor for:

Welding Supplies and Consumables

Options and Accessories

Service and Repair

Replacement Parts

Owner's Manuals

Contact the Delivering Carrier to:

File a claim for loss or damage during shipment.

For assistance in filing or settling claims, contact your distributor and/or equipment manufacturer's Transportation Department.

ITW Welding Products Italy S.r.l.

Via Privata Iseo, 6/E

20098 San Giuliano

Milanese, Italy

Phone: 39 (0) 2982901

Fax: 39 (0) 298290-203

email: miller@itw-welding.it

