

POWERTEC® i250C STANDARD
POWERTEC® i250C ADVANCED
POWERTEC® i320C STANDARD
POWERTEC® i320C ADVANCED

OPERATOR'S MANUAL



ENGLISH



Lincoln Electric Bester Sp. z o.o.
ul. Jana III Sobieskiego 19A, 58-263 Bielawa, Poland
www.lincolnelectric.eu

THANKS! For having chosen the **QUALITY** of the Lincoln Electric products.

- Please Examine Package and Equipment for Damage. Claims for material damaged in shipment must be notified immediately to the dealer.
- For future reference record in the table below your equipment identification information. Model Name, Code & Serial Number can be found on the machine rating plate.

Model Name:
Code & Serial number:
Date & Where Purchased:

ENGLISH INDEX

Technical Specifications.....	1
ECO design information	2
Electromagnetic Compatibility (EMC).....	4
Safety	5
Introduction	7
Installation and Operator Instructions.....	7
WEEE	37
Spare Parts	37
REACH	37
Authorized Service Shops Location	37
Electrical Schematic	37
Accessories	38

Technical Specifications

NAME		INDEX			
POWERTEC® i250C STANDARD		K14157-1			
POWERTEC® i250C ADVANCED		K14157-2			
POWERTEC® i320C STANDARD		K14158-1			
POWERTEC® i320C ADVANCED		K14158-2			
INPUT					
	Input Voltage U ₁	EMC Class		Frequency	
K14157-1 K14157-2 K14158-1 K14158-2	400V ± 10% 3-phase	A		50/60Hz	
	Input Power at Rated Cycle	Input Amperes I _{1max}		PF	
K14157-1 K14157-2	10,3 kVA @ 60% Duty Cycle (40°C)	14,7A		0,85	
K14158-1 K14158-2	13,6 kVA @ 40% Duty Cycle (40°C)	19,6A		0,90	
RATED OUTPUT					
		Open Circuit Voltage	Duty Cycle 40°C (based on a 10 min. period)	Output Current	Output Voltage
K14157-1 K14157-2	GMAW	49Vdc	60%	250A	26,5Vdc
			100%	195A	23,8Vdc
	FCAW	49Vdc	60%	250A	26,5Vdc
			100%	195A	23,8Vdc
	SMAW	49Vdc	60%	250A	30Vdc
			100%	195A	27,8Vdc
K14158-1 K14158-2	GMAW	49Vdc	40%	320A	30Vdc
			100%	195A	23,8Vdc
	FCAW	49Vdc	40%	320A	30Vdc
			100%	195A	23,8Vdc
	SMAW	49Vdc	40%	320A	32,8Vdc
			100%	195A	27,8Vdc
WELDING CURRENT RANGE					
	GMAW	FCAW	SMAW		
K14157-1	10A÷250A	10A÷250A	20A÷250A		
K14157-2	10A÷250A	10A÷250A	20A÷250A		
K14158-1	10A÷320A	10A÷320A	20A÷320A		
K14158-2	10A÷320A	10A÷320A	20A÷320A		
RECOMMENDED INPUT CABLE AND FUSE SIZES					
	Fuse Type gR or Circuit Breaker Type Z		Power Lead		
K14157-1	16A, 400V AC		4 Conductor, 2,5mm ²		
K14157-2	16A, 400V AC		4 Conductor, 2,5mm ²		
K14158-1	20A, 400V AC		4 Conductor, 2,5mm ²		
K14158-2	20A, 400V AC		4 Conductor, 2,5mm ²		
DIMENSION					
Weight	Height	Width		Length	
67 kg	870 mm	540 mm		900 mm	
Protection Rating	Operating Humidity (t=20°C)	Operating Temperature		Storage Temperature	
IP23	≤ 90 %	from -10 °C to +40 °C		from -25 °C to +55 °C	

ECO design information

The equipment has been designed in order to be compliant with the Directive 2009/125/EC and the Regulation 2019/1784/EU.

Efficiency and idle power consumption:

Index	Name	Efficiency when max power consumption / Idle power consumption	Equivalent model
K14157-1	POWERTEC® i250C STANDARD	87,2% / 27W	No equivalent model
K14157-2	POWERTEC® i250C ADVANCED	87,2% / 27W	No equivalent model
K14158-1	POWERTEC® i320C STANDARD	87,2% / 27W	No equivalent model
K14158-2	POWERTEC® i320C ADVANCED	87,2% / 27W	No equivalent model

Idle state occurs under the condition specified in below table

IDLE STATE	
Condition	Presence
MIG mode	X
TIG mode	
STICK mode	
After 30 minutes of non-working	
Fan off	X

The value of efficiency and consumption in idle state have been measured by method and conditions defined in the product standard EN 60974-1:20XX

Manufacturer's name, product name, code number, product number, serial number and date of production can be read from rating plate.

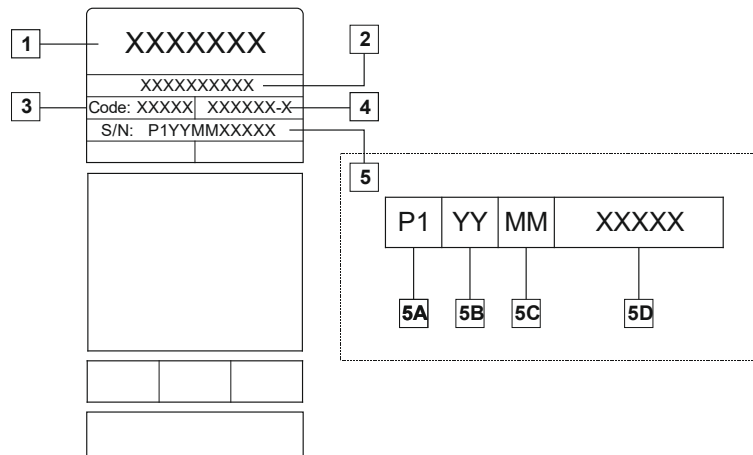

Where:

- 1- Manufacturer name and address
- 2- Product name
- 3- Code number
- 4- Product number
- 5- Serial number
 - 5A- country of production
 - 5B- year of production
 - 5C- month of production
 - 5D- progressive number different for each machine

Typical gas usage for **MIG/MAG** equipment:

Material type	Wire diameter [mm]	DC electrode positive		Wire Feeding [m/min]	Shielding Gas	Gas flow [l/min]
		Current [A]	Voltage [V]			
Carbon, low alloy steel	0,9 ÷ 1,1	95 ÷ 200	18 ÷ 22	3,5 – 6,5	Ar 75%, CO ₂ 25%	12
Aluminium	0,8 ÷ 1,6	90 ÷ 240	18 ÷ 26	5,5 – 9,5	Argon	14 ÷ 19
Austenic stainless steel	0,8 ÷ 1,6	85 ÷ 300	21 ÷ 28	3 - 7	Ar 98%, O ₂ 2% / He 90%, Ar 7,5% CO ₂ 2,5%	14 ÷ 16
Copper alloy	0,9 ÷ 1,6	175 ÷ 385	23 ÷ 26	6 - 11	Argon	12 ÷ 16
Magnesium	1,6 ÷ 2,4	70 ÷ 335	16 ÷ 26	4 - 15	Argon	24 ÷ 28

Tig Process:

In TIG welding process, gas usage depends on cross-sectional area of the nozzle. For commonly used torches:

Helium: 14-24 l/min

Argon: 7-16 l/min

Notice: Excessive flow rates causes turbulence in the gas stream which may aspirate atmospheric contamination into the welding pool.

Notice: A cross wind or draft moving can disrupt the shielding gas coverage, in the interest of saving of protective gas use screen to block air flow.



End of life

At end of life of product, it has to be disposal for recycling in accordance with Directive 2012/19/EU (WEEE), information about the dismantling of product and Critical Raw Material (CRM) present in the product, can be found at <https://www.lincolnelectric.com/en-gb/support/Pages/operator-manuals-eu.aspx>

Electromagnetic Compatibility (EMC)

11/04

This machine has been designed in accordance with all relevant directives and standards. However, it may still generate electromagnetic disturbances that can affect other systems like telecommunications (telephone, radio, and television) or other safety systems. These disturbances can cause safety problems in the affected systems. Read and understand this section to eliminate or reduce the amount of electromagnetic disturbance generated by this machine.

WARNING

Provided that the public low voltage system impedance at the point of common coupling is lower than:

- 56,4 mΩ for the **POWERTEC® I250C STANDARD**
- 56,4 mΩ for the **POWERTEC® I250C ADVANCED**
- 56,4 mΩ for the **POWERTEC® I320C STANDARD**
- 56,4 mΩ for the **POWERTEC® I320C ADVANCED**

This equipment is compliant with IEC 61000-3-11 and IEC 61000-3-12 and can be connected to public low voltage systems. It is the responsibility of the installer or user of the equipment to ensure, by consultation with the distribution network operator if necessary, that the system impedance complies with the impedance restrictions.

Consider the following guidelines to reduce electromagnetic emissions from the machine.

- Connect the machine to the input supply according to this manual. If disturbances occur it may be necessary to take additional precautions such as filtering the input supply.
- The output cables should be kept as short as possible and should be positioned together. If possible connect the work piece to ground in order to reduce the electromagnetic emissions. The operator must check that connecting the work piece to ground does not cause problems or unsafe operating conditions for personnel and equipment.
- Shielding of cables in the work area can reduce electromagnetic emissions. This may be necessary for special applications.

WARNING

The Class A equipment is not intended for use in residential locations where the electrical power is provided by the public low-voltage supply system. There may be potential difficulties in ensuring electromagnetic compatibility in those locations, due to conducted as well as radiated disturbances.



WARNING





While a high electromagnetic field occurs, a welding current can fluctuate.



WARNING

This equipment must be used by qualified personnel. Be sure that all installation, operation, maintenance and repair procedures are performed only by qualified person. Read and understand this manual before operating this equipment. Failure to follow the instructions in this manual could cause serious personal injury, loss of life, or damage to this equipment. Read and understand the following explanations of the warning symbols. Lincoln Electric is not responsible for damages caused by improper installation, improper care or abnormal operation.

	<p>WARNING: This symbol indicates that instructions must be followed to avoid serious personal injury, loss of life, or damage to this equipment. Protect yourself and others from possible serious injury or death.</p>
	<p>READ AND UNDERSTAND INSTRUCTIONS: Read and understand this manual before operating this equipment. Arc welding can be hazardous. Failure to follow the instructions in this manual could cause serious personal injury, loss of life, or damage to this equipment.</p>
	<p>ELECTRIC SHOCK CAN KILL: Welding equipment generates high voltages. Do not touch the electrode, work clamp, or connected work pieces when this equipment is on. Insulate yourself from the electrode, work clamp, and connected work pieces.</p>
	<p>ELECTRICALLY POWERED EQUIPMENT: Turn off input power using the disconnect switch at the fuse box before working on this equipment. Ground this equipment in accordance with local electrical regulations.</p>
	<p>ELECTRICALLY POWERED EQUIPMENT: Regularly inspect the input, electrode, and work clamp cables. If any insulation damage exists replace the cable immediately. Do not place the electrode holder directly on the welding table or any other surface in contact with the work clamp to avoid the risk of accidental arc ignition.</p>
	<p>ELECTRIC AND MAGNETIC FIELDS MAY BE DANGEROUS: Electric current flowing through any conductor creates electric and magnetic fields (EMF). EMF fields may interfere with some pacemakers, and welders having a pacemaker shall consult their physician before operating this equipment.</p>
	<p>CE COMPLIANCE: This equipment complies with the European Community Directives.</p>
	<p>ARTIFICIAL OPTICAL RADIATION: According with the requirements in 2006/25/EC Directive and EN 12198 Standard, the equipment is a category 2. It makes mandatory the adoption of Personal Protective Equipments (PPE) having filter with a protection degree up to a maximum of 15, as required by EN169 Standard.</p>
	<p>FUMES AND GASES CAN BE DANGEROUS: Welding may produce fumes and gases hazardous to health. Avoid breathing these fumes and gases. To avoid these dangers the operator must use enough ventilation or exhaust to keep fumes and gases away from the breathing zone.</p>
	<p>ARC RAYS CAN BURN: Use a shield with the proper filter and cover plates to protect your eyes from sparks and the rays of the arc when welding or observing. Use suitable clothing made from durable flame-resistant material to protect you skin and that of your helpers. Protect other nearby personnel with suitable, non-flammable screening and warn them not to watch the arc nor expose themselves to the arc.</p>

	<p>WELDING SPARKS CAN CAUSE FIRE OR EXPLOSION: Remove fire hazards from the welding area and have a fire extinguisher readily available. Welding sparks and hot materials from the welding process can easily go through small cracks and openings to adjacent areas. Do not weld on any tanks, drums, containers, or material until the proper steps have been taken to insure that no flammable or toxic vapors will be present. Never operate this equipment when flammable gases, vapors or liquid combustibles are present.</p>
	<p>WELDED MATERIALS CAN BURN: Welding generates a large amount of heat. Hot surfaces and materials in work area can cause serious burns. Use gloves and pliers when touching or moving materials in the work area.</p>
	<p>CYLINDER MAY EXPLODE IF DAMAGED: Use only compressed gas cylinders containing the correct shielding gas for the process used and properly operating regulators designed for the gas and pressure used. Always keep cylinders in an up Right position securely chained to a fixed support. Do not move or transport gas cylinders with the protection cap removed. Do not allow the electrode, electrode holder, work clamp or any other electrically live part to touch a gas cylinder. Gas cylinders must be located away from areas where they may be subjected to physical damage or the welding process including sparks and heat sources.</p>
	<p>SAFETY MARK: This equipment is suitable for supplying power for welding operations carried out in an environment with increased hazard of electric shock.</p>

The manufacturer reserves the Right to make changes and/or improvements in design without upgrade at the same time the operator's manual.

Introduction

General Description

The welding machines

POWERTEC® i250C STANDARD
POWERTEC® i250C ADVANCED
POWERTEC® i320C STANDARD
POWERTEC® i320C ADVANCED

enables welding:

- GMAW (MIG/MAG),
- FCAW (Flux-Cored),
- SMAW (MMA),

The following equipment has been added to

POWERTEC® i250C STANDARD
POWERTEC® i250C ADVANCED
POWERTEC® i320C STANDARD
POWERTEC® i320C ADVANCED

- Work lead – 3m,
- Gas hose – 2m,
- Driving roll V1.0/V1.2 for solid wire (mounted in the wire feeder).

Recommended equipment, which can be bought by user, was mentioned in the chapter "Accessories".

Installation and Operator Instructions

Read this entire section before installation or operation of the machine.

Location and Environment

This machine will operate in harsh environments. However, it is important that simple preventative measures are followed to assure long life and reliable operation.

- Do not place or operate this machine on a surface with an incline greater than 15° from horizontal.
- Do not use this machine for pipe thawing.
- This machine must be located where there is free circulation of clean air without restrictions for air movement to and from the air vents. Do not cover the machine with paper, cloth or rags when switched on.
- Dirt and dust that can be drawn into the machine should be kept to a minimum.
- This machine has a protection rating of IP23. Keep it dry when possible and do not place it on wet ground or in puddles.
- Locate the machine away from radio controlled machinery. Normal operation may adversely affect the operation of nearby radio controlled machinery, which may result in injury or equipment damage. Read the section on electromagnetic compatibility in this manual.
- Do not operate in areas with an ambient temperature greater than 40°C.

Duty cycle and Overheating

The duty cycle of a welding machine is the percentage of time in a 10 minute cycle at which the welder can operate the machine at rated welding current.

Example: 60% duty cycle

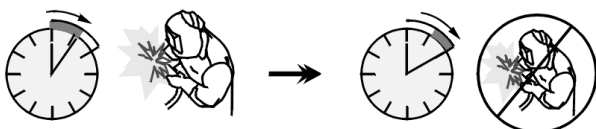

Welding for 6 minutes.

Break for 4 minutes.

Excessive extension of the duty cycle will cause the thermal protection circuit to activate.

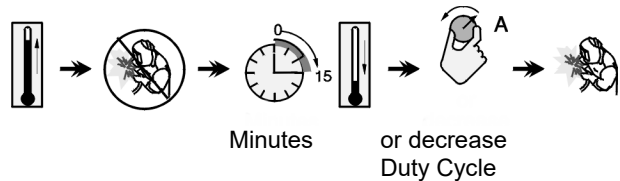

Input Supply Connection

⚠ WARNING

Only a qualified electrician can connect the welding machine to the supply network. Installation had to be made in accordance with the appropriate National Electrical Code and local regulations.

Check the input voltage, phase and frequency supplied to this machine before turning it on. Verify the connection of ground wires from the machine to the input source. The welding machine **POWERTEC® i250C STANDARD/ ADVANCED**, **POWERTEC® i320C STANDARD/ ADVANCED** must be connected to a correctly installed plug-in socket with an earth pin. Input voltage is 400 Vac 50/60Hz. For more information about input supply refer to the technical specification section of this manual and to the rating plate of the machine.

Make sure that the amount of mains power available from the input supply is adequate for normal operation of the machine. The necessary delayed fuse or circuit breaker and cable sizes are indicated in the technical specification section of this manual.

⚠ WARNING

The welding machine can be supplied from a power generator of output power at least 30% larger than input power of the welding machine.

⚠ WARNING

When powering the machine from a generator be sure to turn off welder first, before generator is shut down, in order to prevent damage to welder!

Output Connections

Refer to points [3], [4] and [5] of the Figures below.

Controls and Operational Features

Front Panel Standard Version

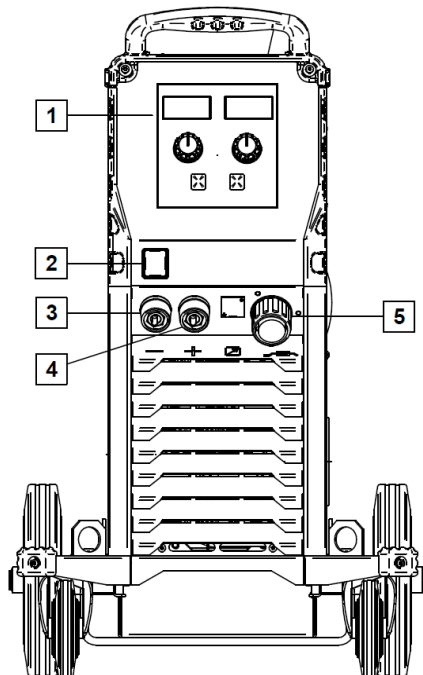



Figure 1

1. U0 User Interface: See "User Interfaces" Chapter.
2. Power Switch ON/OFF (I/O): Controls the input power to the machine. Be sure the power source is connected to the mains supply before turning power on ("I"). After input power is connected and the power switch is turned on, the indicator will light up to indicate the machine is ready to weld.
3. Negative Output Socket for the Welding Circuit: For connecting an electrode holder with lead / work lead. 
4. Positive Output Socket for the Welding Circuit: For connecting an electrode holder with lead / work lead. 
5. EURO Socket: For connecting a welding gun (for GMAW / FCAW process).

Front Panel Advanced Version

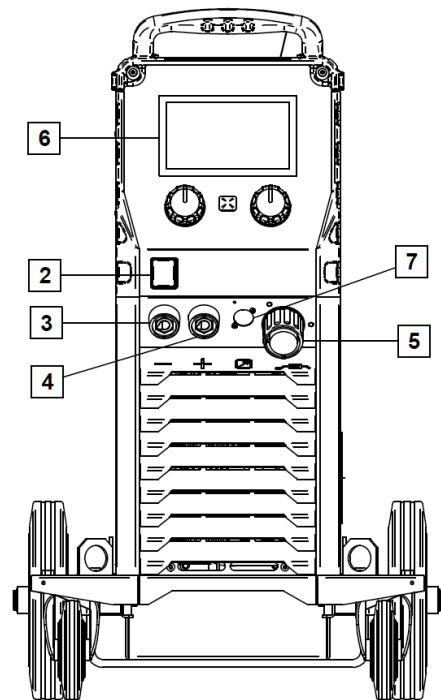

Figure 2

6. U7 User Interface: See User Interfaces chapter.
7. Remote Control Connector Plug: To install Remote Control Kit. This connector allows connection Remote Control. See "Accessories" chapter.

Rear panel

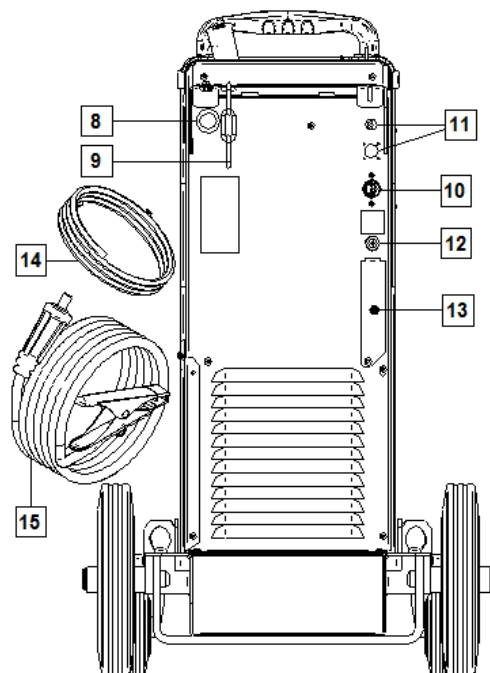

Figure 3

8. Wire Liner Entry: Enables installing liner for welding wire delivered in drum package.
9. Chain: To protect gas bottle.
10. Power Lead (5m): Connect the supply plug to the existing input cable that is rated for the machine as indicated in this manual, and conforms to all applicable standards. This connection shall be performed by a qualified person only.
11. Supply Plug: For CO2 gas heater kit (see "Accessories" chapter).
12. Gas Connector: Connection for gas line.
13. Gas Flow Regulator Plug: Gas flow regulator can be purchased separately (see "Accessories" chapter).
14. Gas hose
15. Work Lead

Internal Controls

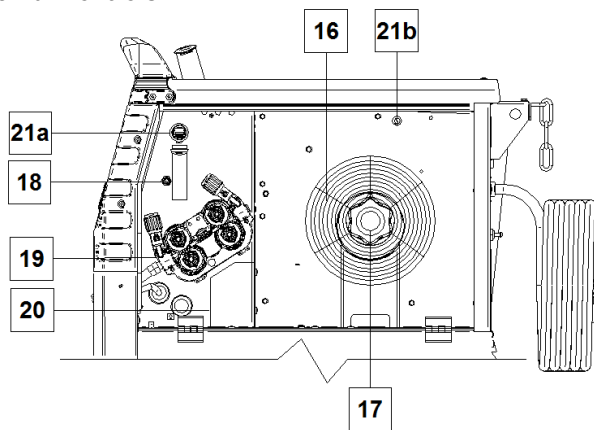

Figure 4

16. Spooled Wire (for GMAW / FCAW): The machine does not include a spooled wire.
17. Wire Spool Support: Maximum 16kg spools. Accepts plastic, steel and fiber spools onto 51 mm spindle.
Note: Plastic Brake Nut has a Left-hand thread.
18. Cold Inch/ Gas Purge Switch: This switch enables wire feeding or gas flow without turning on output voltage.
19. Wire drive feeding system: 4-Roll wire drive mechanisms with quick-change feed rolls.
20. Terminal Block of Changing Polarity Plug (for GMAW / FCAW-SS process): This terminal block enables to set the welding polarity (+ ; -), which will be given at the welding gun (see "Accessories" chapter).
- 21a. USB Receptacle Type A (Advanced only): For USB memory stick connection. For machine software update and service purpose.
- 21b. Fuse F1: Use the 1A/400V (6,3x32mm) low blow fuse.

Standard User Interface (U0)

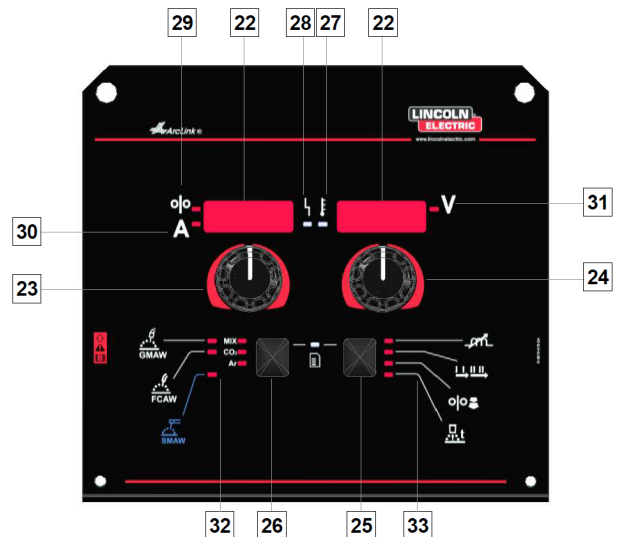

Figure 5

22. Display:
 - Left display: Shows wire feed speed or welding current. During welding shows the actual welding current value.
 - Right display: Shows the welding voltage in volts units. During welding shows the actual welding voltage value.
23. Right Control: Adjusts values on the Right display.
24. Left Control: Adjusts values on the Left display.
25. Right Button: Enables scrolling, changing and setting welding parameters.
26. Left Button: Enables changing the welding process.
27. Thermal Overload Indicator: It indicates that the machine is overloaded or that the cooling is not sufficient.
28. Status LED: A two color light that indicates system errors. Normal operation is steady green light. Error conditions are indicated, per Table 1.

WARNING

The status light will flash green, and sometimes red and green, for up to one minute when the machine is first turned on. When the power source is powered it can take as long as 60 seconds for the machine to be ready to weld. This is a normal situation as the machine goes through initialization.

Table 1





LED Light Condition	Meaning
	Only machines which using ArcLink® protocol for communication
Steady Green	System OK. Power source is operational, and is communicating normally with all healthy peripheral equipment.
Blinking Green	Occurs during power up or a system reset, and indicates the power source is mapping (identifying) each component in the system. Normal for first 1-10 seconds after power is turned on, or if the system configuration is changed during operation.
Alternating Green and Red	If the status lights are flashing any combination of red and green, errors are present in the power source.
	Individual code digits are flashed in red with a long pause between digits. If more than one code is present, the codes will be separated by green light. Read the error code before the machine is turned off. If occurs, to clear the error try to turn Off the machine, wait for a few seconds, then turn ON again. If the error remains, a maintenance is required. Please contact the nearest authorized technical service center or Lincoln Electric and report the error code read.
Steady Red	Indicate no communication between the power source and device which has been connected to this power source.

- 29. LED Indicator: Informs that the wire feed speed is on the Left display.
- 30. LED Indicator: Informs that the value on the Left display is in ampere units.
- 31. LED Indicator: Informs that the value on the Right display is in volts unit.
- 32. Welding Programs Indicators: lamps indicate the active weld mode. Descriptions of parameters are in Table 2.
- 33. Welding parameters Indicators: lamps indicate the active weld parameters. Descriptions of parameters are in Table 3.

Welding Process Change

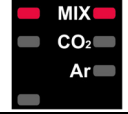
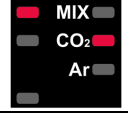
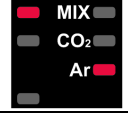
It is possible to quick recall of one of the six manual welding programs - Table 2.

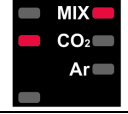
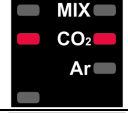
Table 2. Manual Weld Modes:

Symbol	LED	Process
 GMAW		GMAW MIX
		GMAW CO ₂
		GMAW AR
 FCAW		FCAW MIX
		FCAW CO ₂
 SMAW		SMAW

To set the welding process:

- Press the Left Button [26] to select an adequate welding process- the weld program indicator [32] the first weld program indicator [32] lights on.
- Again, press the Left Button [26] the weld program indicator will jump to the next mode.

 **WARNING**

During switching the displays show a “creeping line” on the screen.

Quick Access and Configuration Menu for U0 User Interface

Users have access to the two menu levels:

- Quick Access – basic menu which is connected with setting the Welding Parameters.
- Configuration Menu – advanced menu, configures the device setting.

WARNING

The Menu cannot be accessed if the system is welding, or if there is a fault (status LED is not solid green).

The availability parameters in the Quick Access and Configuration Menu depend on the selected welding program / welding process.

After the device has been restarted the user settings are restored.

Parameter Selection Mode – the Parameter Name on the Left Display blinking.

Parameter Change Value Mode – the parameter value on the Right Display blinking.

Quick Access







To set the parameter of Quick Access (Table 3):

- Press the Right Button [25] to select mode.
- Turn the Right Knob [24] to set the value of parameter.
- Press the Left Button [26] to return to main menu.

WARNING

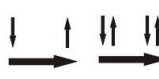
If user do not press Left button, system return automatically to the main menu after few seconds.

Table 3 The default settings of Quick Access

Parameter		Definition
		<p>Inductance – controls the arc characteristics when short-arc welding. increasing Inductance greater than 0.0 results in a crisper arc (more spatter) while decreasing the Inductance to less than 0.0 provides a softer arc (less spatter).</p> <ul style="list-style-type: none"> • Adjust range: from -10 to +10. • Factory default, Pinch is OFF.
		<p>The 2-Step - 4-Step changes the function of the gun's trigger.</p> <ul style="list-style-type: none"> • 2 Step trigger operation turns welding on and off in direct response to the trigger. Welding process is performed when the gun's trigger is pulled. • 4-Step mode allows to continue welding, when the gun's trigger is released. To stop welding, the gun's trigger is pulled again. 4-step mode facilitates to making long welds. <p>Note: 4-Step does not work during Spot Welding.</p>
		<p>Run-in WFS – sets the wire feed speed from the time the trigger is pulled until an arc is established.</p> <ul style="list-style-type: none"> • Factory default, Run-in is turned off. • Adjust range: from minimum to 3,81 m/min (150 in/min).
		<p>Burnback Time – is the amount of time that the weld output continues after the wire stops feeding. It prevents the wire from sticking in the puddle and prepares the end of the wire for the next arc start.</p> <ul style="list-style-type: none"> • Factory default, Burnback Time is set at AUTO. • Adjust range: from 0 (OFF) to 0,25 seconds.

Configuration Menu:

To set the parameter of Configurations Menu:







- Press the Left Button [26] and the Right Button [25] simultaneously to get the access of menu.
- Turn the Left Knob [23] to choose the parameter.
- Press the Right Button [25] to confirm the selection.
- Turn the Right Knob [24] to choose the value of parameter.





- Press the Right Button [25] to confirm the selection.
- Press the Left Button [26] to back to the previous menu and confirm the chosen value.

WARNING

To exit the menu with changes saved, press the Left [26] and the Right [25] Buttons simultaneously. After one minute of inactivity the Menu without saving will also exit.





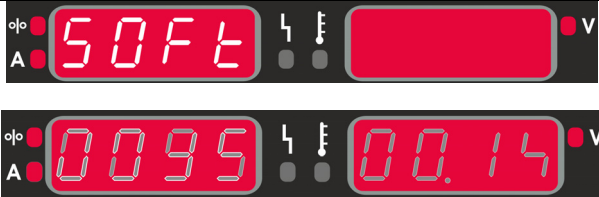



















































Table 4 The default settings of Configuration Menu

Parameter	Definition
	Spot Timer – adjusts the time welding will continue even if the trigger is still pulled. This option has no effect in 4-Step Trigger Mode.
	Crater Procedure – turn ON/OFF the Crater Settings Procedure: <ul style="list-style-type: none"> • ON (factory default) – Crater can be adjusted. The Crater Settings Procedure is assigned to the Right Button. During adjusting Crater, the LED Indicator [25] lights. • OFF – The Crater Settings Procedure is OFF. After press the Right Button, The Crater Settings Procedure is ignored.
	Prewflow Time – adjusts the time that shielding gas flows after the trigger is pulled and prior to feeding. <ul style="list-style-type: none"> • Factory default, Prewflow Time is set at 0 seconds. • Adjust range: from 0,1 seconds to 25 seconds.
	Postflow Time – adjusts the time that shielding gas flows after the welding output turns off. <ul style="list-style-type: none"> • Factory default, Postflow Time is set at 0 seconds. • Adjust range: from 0,1 seconds to 25 seconds.
	Arc/Loss Time – this option can be used to optionally shut off output if an arc is not established, or is lost for a specified amount of time. Error 269 will be displayed if the machine times out. If the value is set to OFF, machine output will not be turned off if an arc is not established nor will output be turned off if an arc is lost. The trigger can be used to hot feed the wire (default). If a value is set, the machine output will shut off if an arc is not established within the specified amount of time after the trigger is pulled or if the trigger remains pulled after an arc is lost. To prevent nuisance errors, set Arc Start/Loss Error Time to an appropriate value after considering all welding parameters (run-in wire feed speed, weld wire feed speed, electrical stick out, etc). <ul style="list-style-type: none"> • OFF (0) to 10 seconds (default = Off) Note: This parameter is disabled while welding in Stick, TIG or Gouge.
	Screen Brightness – enables setting the displays brightness level. Adjust range from 1 to 10, where 5 is default.
	Feedback Persist – determines how feedback values are displayed following a weld: <ul style="list-style-type: none"> • "Off" (factory default) – last recorded feedback values will blink for 5 seconds following a weld, then return to present display mode. • "On" – last recorded feedback values will blink indefinitely following a weld until a Control or button is touched, or an arc is struck.

	<p>Wire Feed Speed (WFS) units – enables change WFS units:</p> <ul style="list-style-type: none"> • CE (factory default) = m/min; • US = in/min.
	<p>HOT START – value in percentage of nominal value welding current during arc start current. The control is used to set the level of the increased current and arc start current is made easy.</p> <ul style="list-style-type: none"> • Adjust range: from 0 to +10.
	<p>ARC FORCE – the output current is temporarily increased to clear short circuit connections between the electrode and the workpiece.</p> <p>Lower values will provide less short circuit current and a softer arc. Higher settings will provide a higher short circuit current, a more forceful arc and possibly more spatter.</p> <p>Adjust range: from -10 to +10.</p>
	<p>Restore to Factory Settings – it allows to restore the factory settings.</p>
	<p>View Software version – used for viewing the software version for user interface.</p> <ul style="list-style-type: none"> • First view show effects after getting access to choose the parameter. • Second view show effects after getting access to edit parameter.

Guide's Marking Interface

Table 5 Symbols description

	Select Welding Process		Select Welding Program		SMAW Process (MMA)
	GMAW Process (MIG/MAG)		FCAW Process		Recall from the User Memory
	Save to the User Memory		User Setup		Advanced Setup
	Configuration		Arc Force		Hot Start
	Pinch		Prewflow Time		Postflow Time
	Burnback Time		Run-in WFS		Select Function of Gun Trigger (2-Step / 4-Step)
	Memory Limits		2-Step		Crater Procedure
	Spot Welding Settings		4-Step		Start Procedure
	Cold Feed		Brightness Level		Restore Factory Setting
	View Software and Hardware Version Information		A/B Procedure		USB Memory
	Check Mark		Resignation Mark		Lock / Unlock
	Error		ESCape Button		Confirm Button
	Wire Feed Speed in [in/min]		Welding Voltage		Welding Current
	Locked		Unlocked		Wire Feed Speed in [m/min]
	Set the Language		Support		Display Configuration Settings
	Standard UI look		Advanced UI look		Select Item
	Enable/ Disable Jobs Mode or Select Jobs for Jobs Mode		Enable/ Disable Jobs Save		Lock
	Weld History		Save		Service weld logs
	SnapShot		Load		

User Interface Advanced (U7)



Figure 6

34. Display: 7" TFT display shows welding processes parameters.

35. Left Knob: Sets the value in the top Left corner of the display. Cancel selection. Return to the previous menu.

36. Right Knob: Sets the value in the top Right corner of the display. Confirmation of changes.

37. Button: It enables return to main menu.

Users have access to the two different views of interface:

- Standard view (Figure 7.)
- Advanced view (Figure 8)

To choose the view of interface:

- Press the Button [37] or Right Knob [36].
- Use the Right Knob [36] to highlight the "Configuration" icon.
- Press the Right Knob [36] to confirm decision.
- Use the Right Knob [36] to highlight "UI look" icon.
- Press the Right Knob [36] to confirm decision.
- Select one of the view (Standard – Figure 7 or Advanced – Figure 8).
- Press the button [37] or Left Knob [35] to return to main menu.

Table 6. Different display views

		Functions of Interface Components
<p>Figure 7</p>		<p>38. Status bar.</p> <p>39. The measured value of current.</p> <p>40. The measured value of voltage.</p> <p>41. Parameter Value (wire feed speed or current) regulated by Left Knob [35].</p> <p>42. Parameter Value (voltage, trim or power) regulated by Right Knob [36].</p> <p>43. Welding Parameter Visualization.</p> <p>44. Welding Parameters Bar.</p>
<p>Figure 8</p>		

Status bar

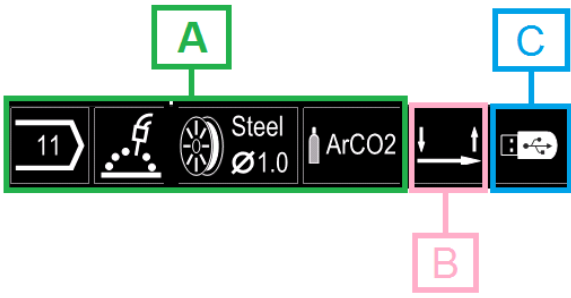

Figure 9

- A) Information about active welding mode
- B) 2/4 step
- C) USB Interface

Welding Parameters Bar

The Welding Parameters Bar enables:

- Welding Program change.
- Wave Control Value change.
- The gun's trigger function change (GMAW, FCAW, SMAW).
- Add or hide functions and welding parameters – User Setup
- Change the Setup

Table 7. GMAW and FCAW Welding Parameters Bar

Symbol	Description
	Welding Process Choice
	Support
	The function of the gun's trigger change
	Pinch
	Configuration Menu (Setup)
	User Setup

! WARNING

The availability parameters depend on the selected welding program / welding process.

Table 8 SMAW Welding Parameters Bar

Symbol	Description
	Welding Process Choice
	Support
	Arc Force
	Hot Start
	Configuration Menu (Setup)
	User Setup

Welding Program Choice

To select the Welding Program:

- Press the Button [37] or Right Knob [36] to get access of Welding Parameters Bar.
- Use the Right Knob [36] to highlight the icon “Welding Process Choice”.
- Press the Right Knob [36] to confirm the selection.

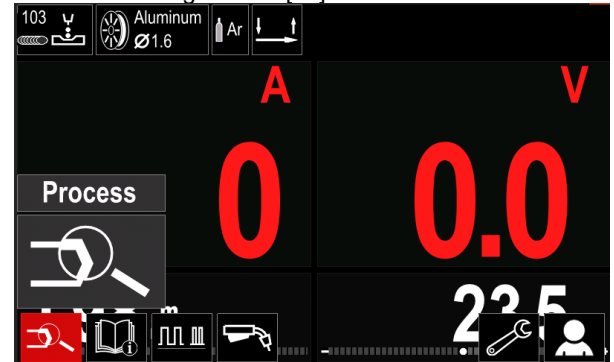

Figure 10

- Use the Right Knob [36] to highlight the icon “Select welding program”.

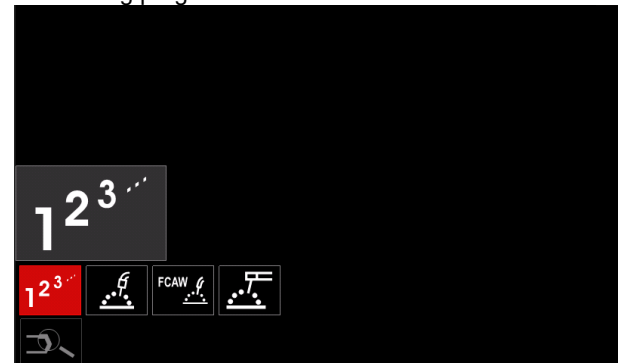

Figure 11

- Press the Right Knob [36] to confirm the selection.

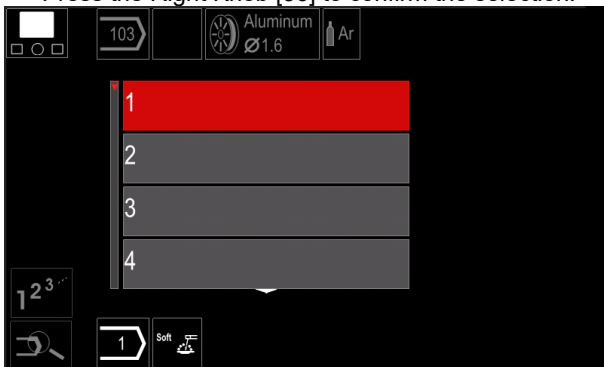

Figure 12

- Use the Right Knob [36] to highlight the program number.
- Press the Right Knob [36] to confirm the selection.

WARNING

The Lists of available programs depends on the power source.

If a user does not know the Welding Program Number, it can be searched. In that case in subsequent steps are given:

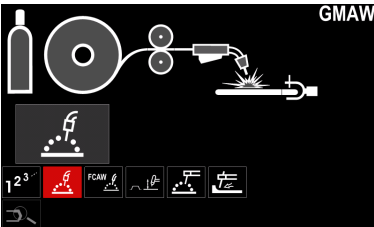
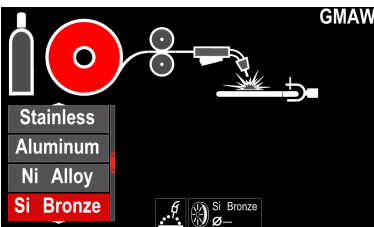
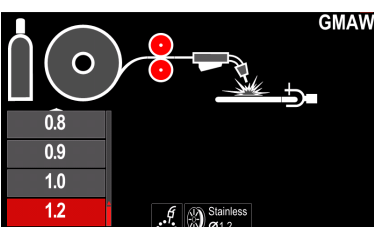
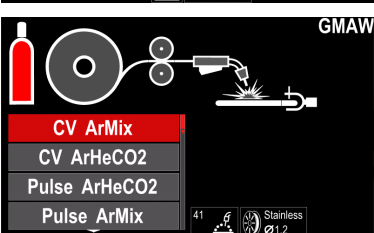
- The Welding Process
 
- The Electrode Wire Type
 
- The Electrode Wire Diameter
 
- The Shielding Gas
 

Support

To access the Support Menu:

- Press the Button [37] or Right Knob [36] to get access of Welding Parameters Bar.
- Use the Right Knob [36] to highlight the icon "Support".
- Press the Right Knob [36] to confirm the selection.

The Support Menu enables to get knowledge of the following points:

- Accessories:
 - Rolls for aluminum wire
 - Rolls for fluxed cored wire
 - Rolls for steel/stainless steel wire
 - TIG torches
 - Electrode & Ground cable
 - MIG/MAG LINC GUN Standard
- Tips and Tricks:
 - Tutorial
 - Welding variables effect MIG

User Setup

To access the User Setup:

- Press the Button [37] or Right Knob [36] to get access of Welding Parameters Bar.
- Use the Right Knob [36] to highlight the icon "Settings".
- Press the Right Knob [36] to confirm the selection.

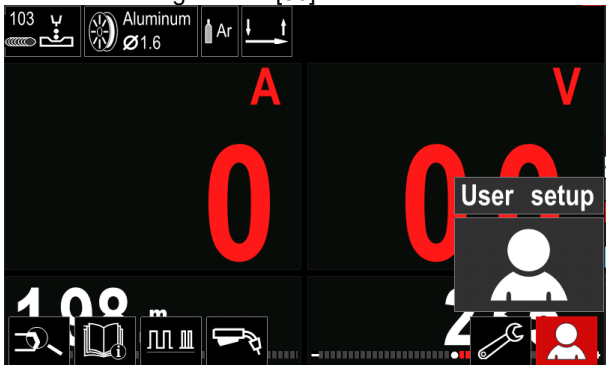

Figure 13

The User Setting Menu enables to add the additional function and / or parameters to the Welding Parameters Bar [44]:

Table 9

Symbol	Description
	Prewelding
	Postflow
	Burnback Time
	Spot Welding
	Run-In WFS
	Start Procedure
	Crater Procedure
	A/B Procedure
	Load memory
	Save memory
	USB Memory

WARNING

To change the Parameters or Functions Value, their icons had to be added to the Welding Parameters Bar [44].

To add the Parameter or Function to the Welding Parameters Bar [44]:

- Access to the User Setup (see the Figure 13).
- Use the Right Knob [36] to highlight the parameter or function icon which will be added to the Welding Parameters Bar [44], for example Run-in WFS.

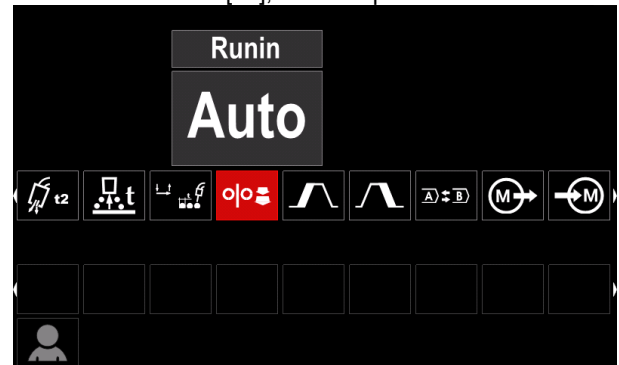

Figure 14

- Press the Right Knob [36] to confirm the selection. Run-in WFS icon will drop.

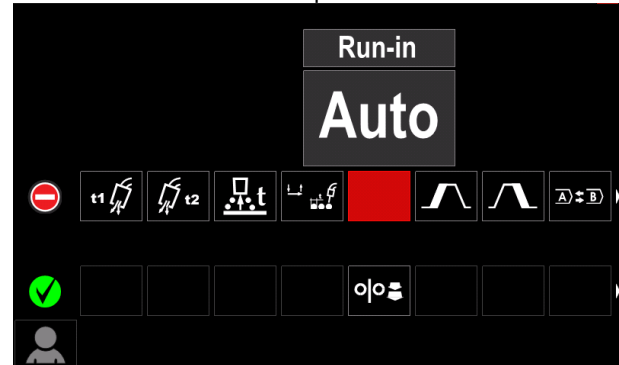

Figure 15

WARNING

To remove the icon - press the Right Knob [36] once again.

To exit the User Setup Menu – press the Left Button [35].

- The Selected parameters or function is added to the Welding Parameters Bar [44].

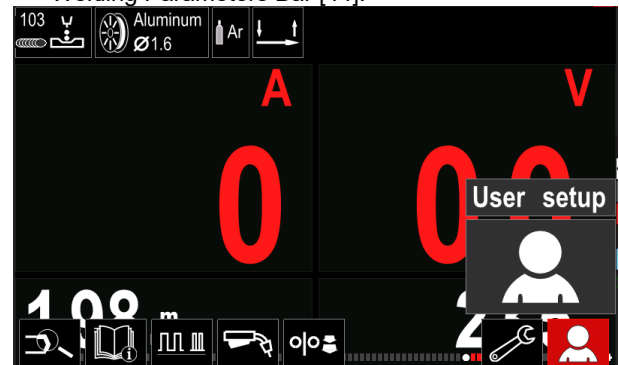

Figure 16

To remove the selected parameter or function from the Welding Parameters Bar [44]:

- Access to the User Setup.
- Use the Right Knob [36] to highlight the parameter or function icon which is added to the Welding Parameters Bar [44].

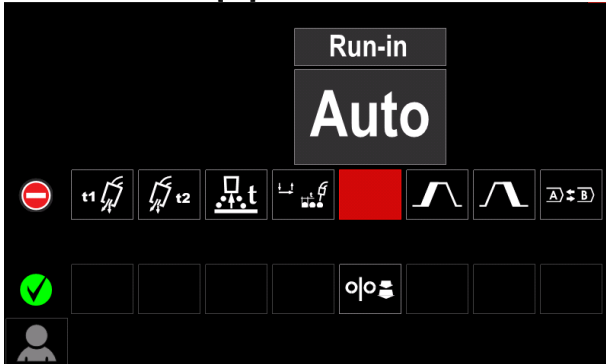

Figure 17

- Press the Right Knob [36] – The selected icon will disappear from the display bottom.

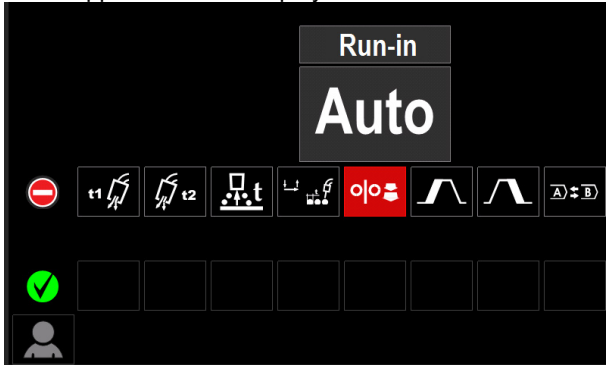

Figure 18

- The Selected parameters or function was disappeared from the Welding Parameters Bar [44]

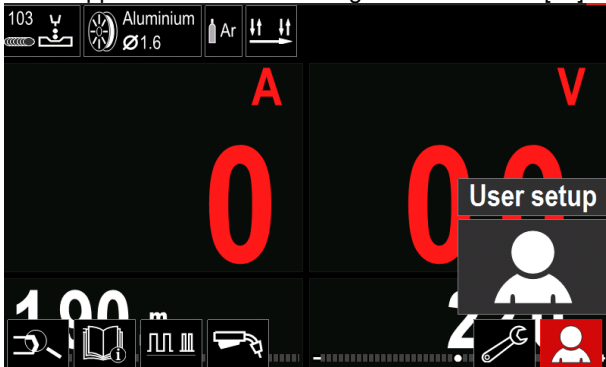

Figure 19



Preflow Time adjusts the time that shielding gas flows after the trigger is pulled and prior to feeding.

- Adjust range: from 0 seconds (OFF) to 25 seconds (factory default is set at Auto mode).



Postflow Time adjusts the time that shielding gas flows after the welding output turns off.

- Adjust range: from 0 seconds (OFF) to 25 seconds (factory default is set at Auto mode).



Burnback Time is the amount of time that the weld output continues after the wire stops feeding. It prevents the end of the wire from sticking in the puddle and prepares the end of the wire for the next arc start.

- Adjust range: from OFF to 0.25 seconds (factory default is set at Auto mode).



Spot Timer– adjusts the time welding will continue even if the trigger is still pulled. This option has no effect in 4-Step Trigger Mode.

- Adjust range: from 0 second (OFF) to 120 seconds (factory default is OFF).

WARNING

Spot Timer has no effect in 4-Step Trigger Mode.



Run-in WFS – sets the wire feed speed from the time the trigger is pulled until an arc is established.

- Adjust range: from minimum to maximum WFS (factory default is set at Auto mode).



The Start Procedure – controls the WFS and Volts (or Trim) for a specified time at the beginning of the weld. During the start time, the machine will ramp up or down from the Start Procedure to the preset Welding Procedure.

- Adjust time range: from 0 seconds (OFF) to 10 seconds.



Crater Procedure – controls the WFS (or value in ampere units) and Volts (or Trim) for a specified time at the end of the weld after the trigger is released. During the Crater time, the machine will ramp up or down from the Weld Procedure to the Crater Procedure.

- Adjust time range: from 0 seconds (OFF) to 10 seconds.

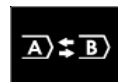

A/B procedure – enables quick weld procedure change. The sequence changes may occur between:

- Two different welding programs.
- Different settings for the same program.



Save Memory: Store the welding programs with their parameters to one of the fifty user Memories.

To save memory:

- Add Save Memory icon to Welding Parameters Bar.
- Use the Right Knob [36] to highlight the icon Save Memory.



Figure 20

- Press the Right Knob [36] to confirm – the Save Memory Menu is shown on the display .
- Use the Right Knob to highlight the memory number where the program would be stored.



Figure 21

- Confirm the selection – Press and hold for 3 second Right Knob [36].



Figure 22

- Rename job – turn Right Knob [36] to select: numbers 0-9, letters A-Z, a-z. Press Right Knob [36] to confirm first character of the name.
- Next characters are selected in the same.
- To confirm the name of job and back to the main menu press Button [37] or Left Knob [35].



Load memory
Recall the stored programs from the user Memory.

To recall the Welding Program from the User Memory:

Note: Before using, the Welding Program had to be assigned to the user memory

- Add the Load memory icon to the Welding Parameters Bar.
- Use the Right Knob [36] to highlight the Load memory icon.
- Press the Right Knob [36] to confirm – the Load Memory Menu is shown on the display.
- Use the Right Knob [36] to highlight the Memory number which from the Welding Program will be recall.
- Confirm the select – press the Right Button [36].



USB
When the USB storage device is connected to USB port – user have access to:

Table 10. USB Menu

Symbol	Description
	Save
	Load

Save - the following data can be save on a USB Memory Stick:

Table 11. Save and restore selection

Symbol	Description
	Current Welding Settings
	Advanced Parameters Configuration (P menu)
	All welding programs stored in user memory
	One of the welding programs stored in user memory

To save data into USB device:

- Connect the USB to welding machine.
- Add USB icon to the Welding parameters bar [44].
- Use the Right Knob [36] to highlight the icon "USB".

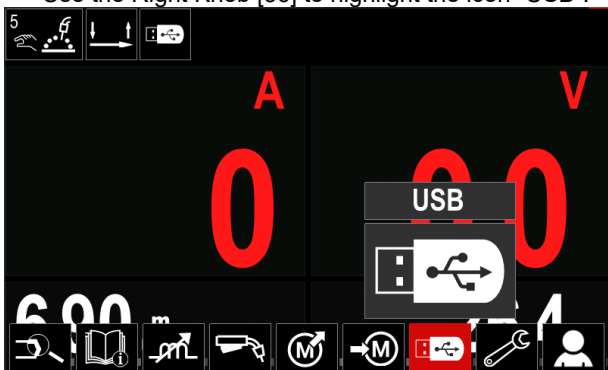

Figure 23

- Press the Right Knob [36] to confirm the selection – the USB menu is shown on the display.
- Use the Right Knob [36] to highlight the icon "Save".



Figure 24

- Press the Right Knob [36] to get access of Save option – the save menu is shown on the display.



Figure 25

- Create or choose a file in which will be saved copies of the data.
- The display shows the Save Data Menu on a USB Memory Stick.

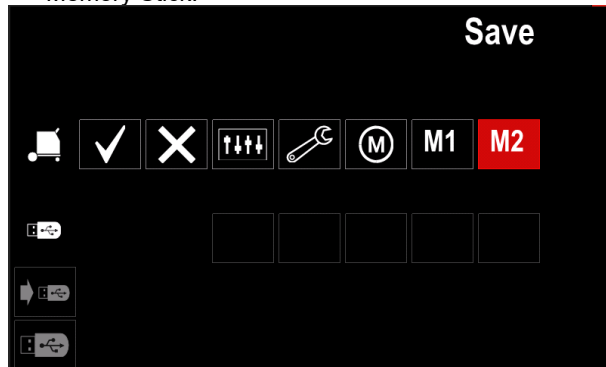

Figure 26

- Use the Set Control [11] to highlight the data icon which will be saved in the file on a USB Memory Stick. For example: Configuration Menu icon.



Figure 27

- Press the Right Knob [36] to confirm.

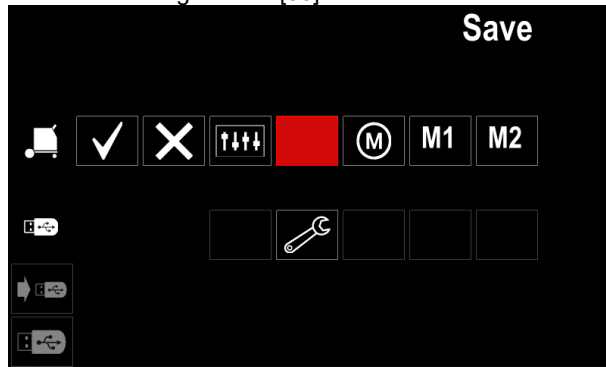

Figure 28

- To confirm and save the data on a USB Memory Stick, highlight the Check Mark icon and then press the Right Knob [36].
- To exit the USB Menu – press the Left Button [37] or disconnect the USB Memory Stick from the USB receptacle.



Load – restore the data from the USB Device to the machine memory.
To load the data from USB Memory:

- Connect the USB to welding machine.
- Add USB icon to the Welding parameters bar [44].
- Use the Right Knob [36] to highlight the icon “USB”.

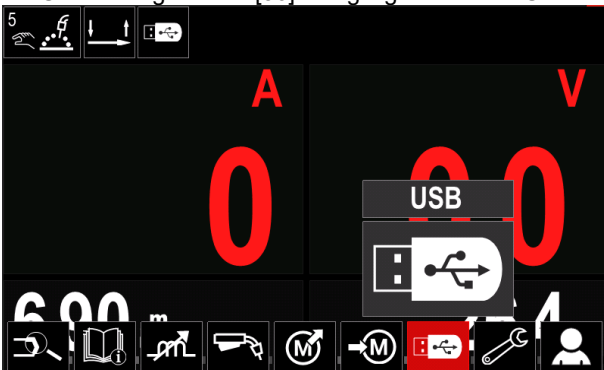

Figure 29

- Press the Right Knob [36] to confirm the selection – the USB menu is shown on the display.
- Use the Right Knob [36] to highlight the icon “Load”.

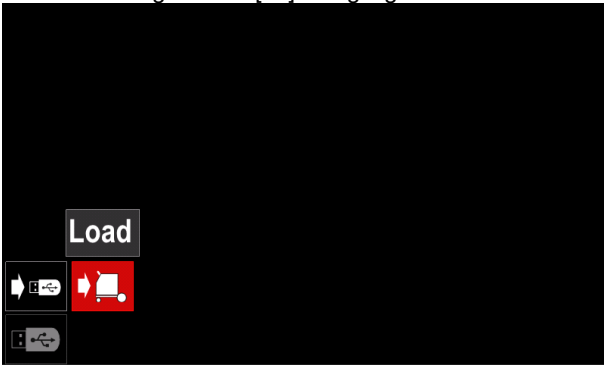

Figure 30

- Press the Right Knob [36] to get access of Load option – the load menu is shown on the display.
- Select the file name with the data to be loaded into interface. Highlight the file icon – use the Right Knob [36].

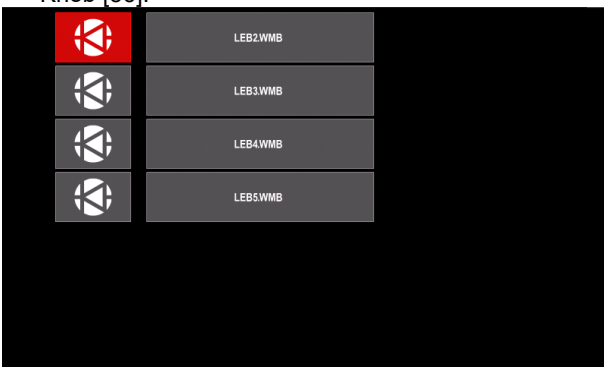

Figure 31

- Press the Right Button [36] to confirm the file selection.
- The display shows the Load Data Menu from a USB Memory Stick to User Interface.
- Use the Right Knob [36] to highlight the data icon which will be loaded.

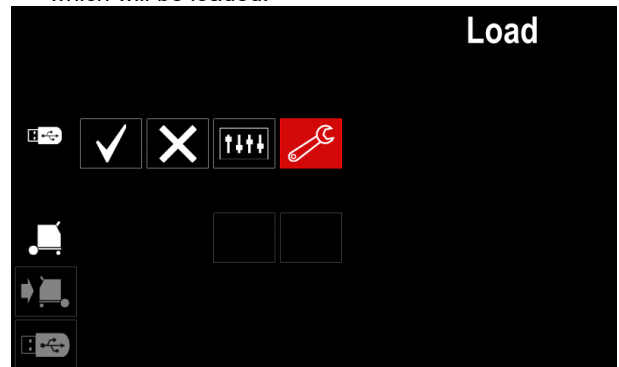

Figure 32

- Press the Right Knob [36] to confirm the data selection.

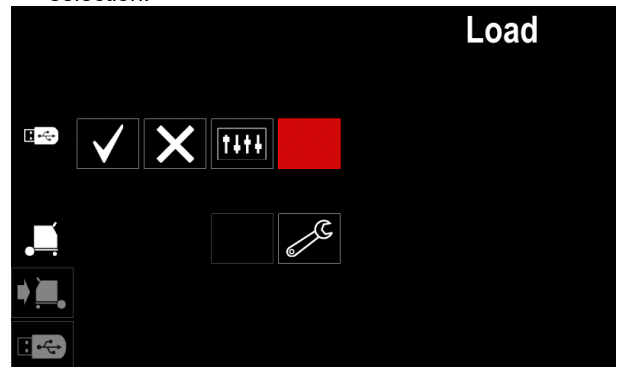

Figure 33

- To confirm and load the data from a USB Memory Stick, highlight the Check Mark icon and then press the Right Knob [36].

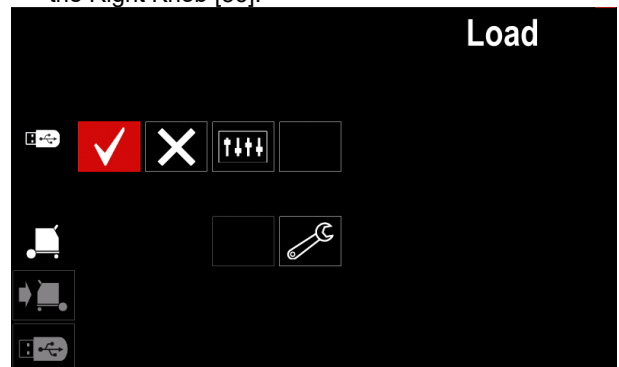

Figure 34

- To exit the USB Menu – press the Left Button [37] or disconnect the USB Memory Stick from the USB receptacle.

Settings and Configuration Menu

To access the Settings and Configuration Menu:

- Press the Button [37] or Right Knob [36] to get access of Welding Parameters Bar.
- Use the Right Knob [36] to highlight the icon “Configuration”.
- Press the Right Knob [36] to confirm the selection.

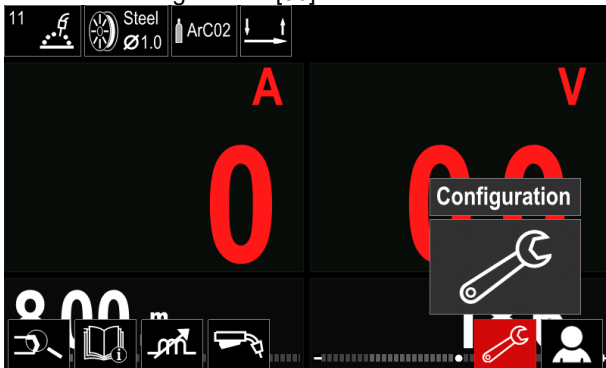

Figure 35

Table 12

Symbol	Description
	Set the Memory Limits
	Set the Display Configuration
	Set the Brightness Level
	Lock / Unlock
	Job Mode
	Set the Language
	Restore Factory Setting
	View Software and Hardware Version Information.
	Access to the Configuration Menu
	Service Menu



Limits – it allows the operator to set the limits of main welding parameters in selected job. The Operator is able to adjust the parameter value within specified limits.

Note: The Limits can be set only for the programs stored in the user memory.

The limits can be set for:

- Welding Current
- Wire Feed Speed
- Welding Voltage
- Wave Controls

To set the range:

- Enter to the Settings and Configuration Menu.
- Use The Right Knob [36] to highlight the “Limits” icon.

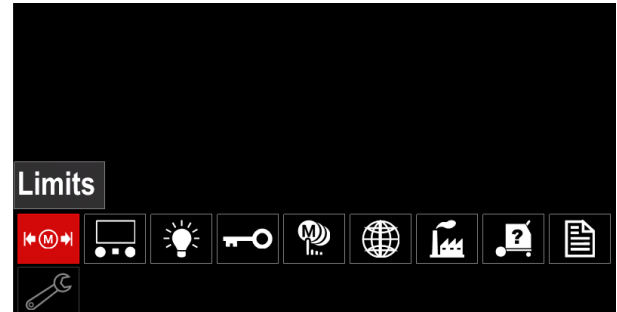

Figure 36

- Press the Right Knob [36] to confirm. List with available job will be displayed on the screen.



Figure 37

- Use the Right Knob [36] to highlight the job.
- Press the Right Knob [36] to confirm selection.



Figure 38

- Use the Right Knob [36] to choose the parameter which will be changed.
- Press the Right Knob [36] to confirm.
- Use the Right Knob [36] to change the value. Press the Right Knob [36] to confirm.
- Figure 39 shows the effect of changing the values of parameters.



Figure 39

- Press the Button [37] to exit with changes.



Display Configuration

Two Display Configuration are available:

Table 13

	Standard view
	Advanced view

To set the Display Configuration:

- Access to the Settings and Configuration Menu.
- Use the Right Knob [36] to highlight the Display Configuration icon.

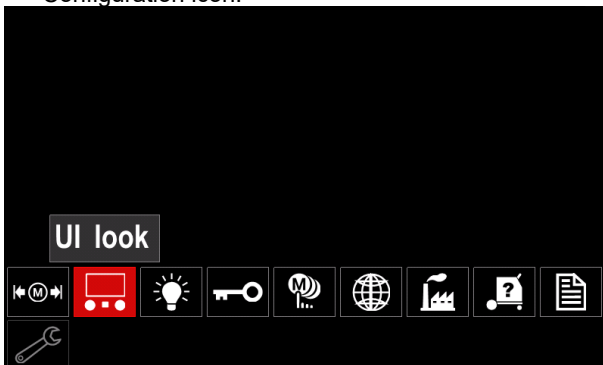

Figure 40

- Press the Right Knob [36]. The Display Configuration Menu is shown on the display.



Figure 41

- Use the Right Knob [36] to choose the display configuration.



The Brightness Level

- it allows to adjust the display brightness from 0 to 10.



Figure 42



Access Control

This function allows following activities.

Table 14

Symbol	Description
	Lock
	Lock function
	Enable/ Disable Jobs
	Select Jobs for Job Work



Lock – it allows to set the password. To set the password:

- Access to the Settings and Configuration Menu.
- Use the Right Knob [36] to highlight the Lock icon.

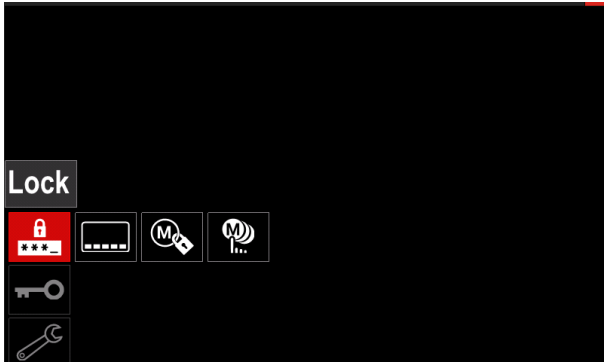

Figure 43

- Press the Right Knob [36]. The password setting menu is shown on the display.

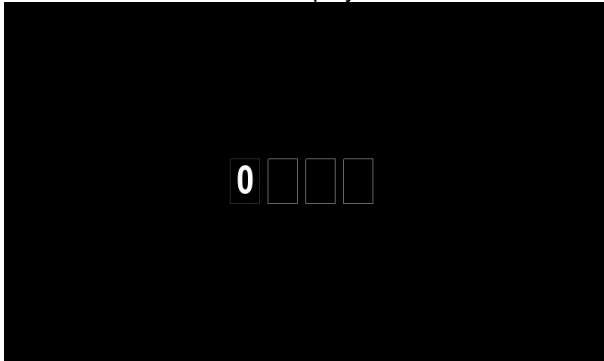

Figure 44

- Turn Right Knob [36] to select: numbers 0-9, Press Right Knob [36] to confirm first character of the password.
- Next numbers are selected in the same method.

Note: After setting last character system exit automatically.



Lock function – it allows to lock/unlock some functions on welding parameters bar. To lock functions:

- Access to the Settings and Configuration Menu.
- Use the Right Knob [36] to highlight the Lock functions icon.

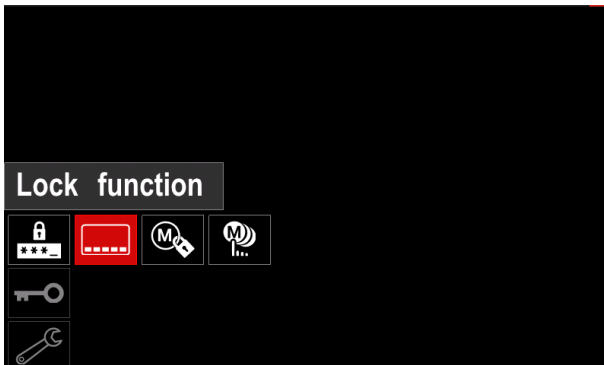

Figure 45

- Press the Right Knob [36]. The Lock Function menu is shown on the display.
- Use the Right Knob [36] to highlight the function (for example "Advanced setup").

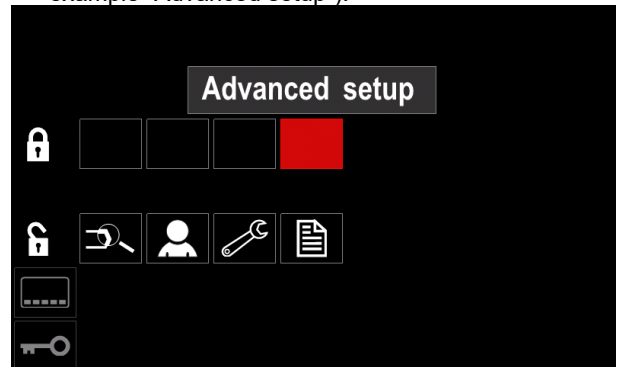

Figure 46

- Press the Right Knob [36]. The icon of chosen parameter will disappear from the lower part of the display (Figure 47). Also this parameter disappear from the Welding parameters bar [44].

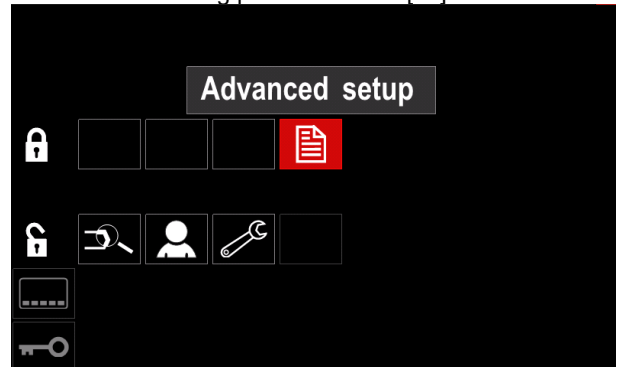

Figure 47

Note: To unlock function user have to do the same steps as steps to lock function.



Enable/ Disable Jobs – it allows to switch off/on jobs to function Save Memory.

To enable/ disable jobs:

- Access to the Settings and Configuration Menu.
- Use the Right Knob [36] to highlight the icon:



Figure 48

- Press the Right Knob [36] to confirm. The Enable/Disable Jobs menu is shown on the display.

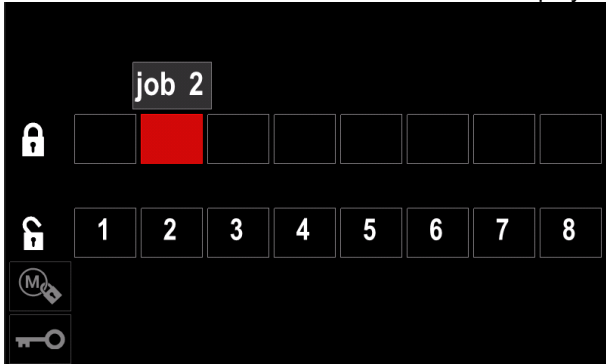

Figure 49

- Use the Right Knob [36] to highlight the job number. The icon of chosen job will disappear from the lower part of the display.

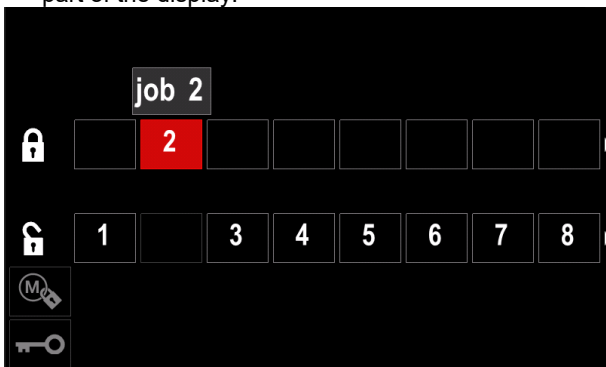

Figure 50

Note: The jobs which are disabled can not be using in "Save memory" function – shown in Figure 51 (job 2 is not available).



Figure 51



Select Jobs for Job Work – it allows to choose which jobs will be enable when Job Mode will be activated.

To select Jobs for Job Work:

- Access to the Settings and Configuration Menu.
- Use the Right Knob [36] to highlight the icon.

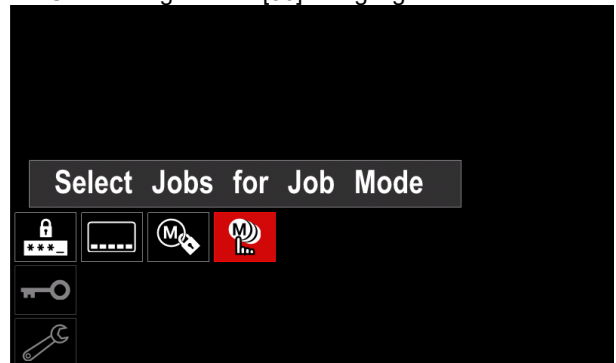

Figure 52

- Press the Right Knob [36] to confirm.
- Use the Right Knob [36] to highlight the job number.
- Press the Right Knob [36] to confirm – the icon of chosen parameter will appear on the lower part of the display.

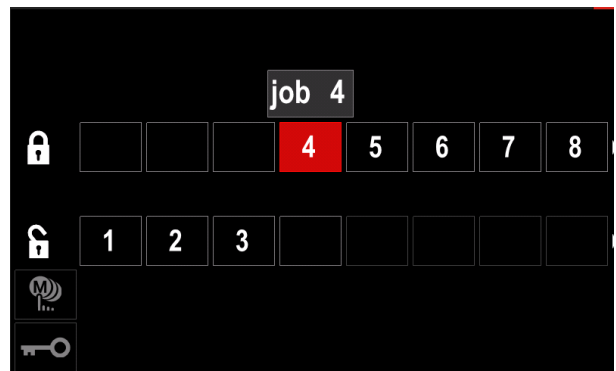

Figure 53

- Press Button [37] to return to main menu.



Job Mode – user has access to operate only with selected jobs.

Note: First of all user have to select jobs which can be used in Job Mode (Access Control -> Select Jobs for Job Work).

To activate Job Mode:

- Access to the Settings and Configuration Menu.
- Use the Right Knob [36] to highlight the Job Mode icon.



Figure 54

- Press the Right Knob [36]. The Job Mode Menu is shown on the display.
- Use the Right Knob [36] to highlight one of the option shown on the figure below.
 - X - Cancel Job Mode
 - ✓ - Activate Job Mode

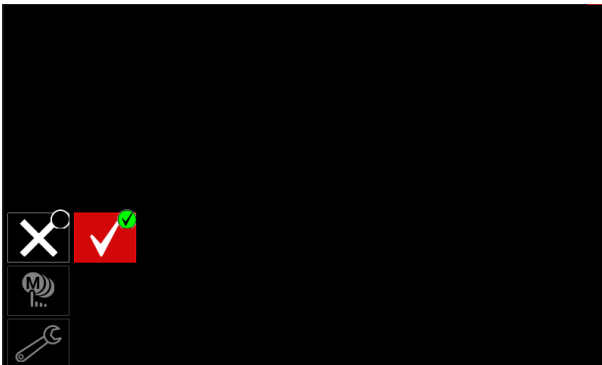

Figure 55

- Press Right Knob [36] to confirm the selection.

Note: After activated Job Mode the icon of this function will be displayed on the Welding Parameters Bar. Also the Load Memory and Save Memory options will be blocked in this mode.



Set the Language – user can choose interface language (English, Polish, Finnish, French, German, Spanish, Italian, Dutch, Romanian).

To set the language:

- Access to the Settings and Configuration Menu.
- Use the Right Knob [36] to highlight the Set the Language icon.

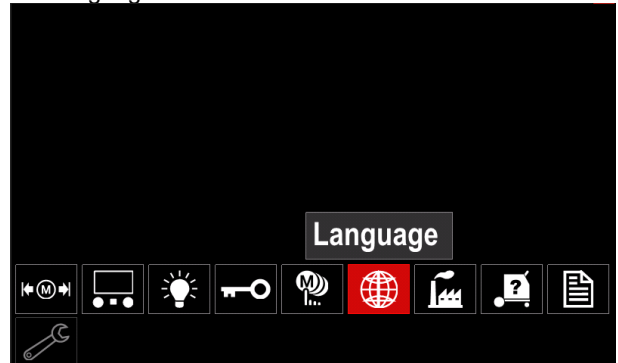

Figure 56

- Press the Right Knob [36]. The Language Menu is shown on the display.

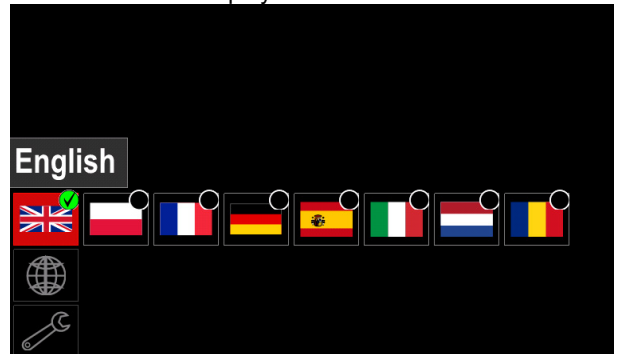

Figure 57

- Use the Right Knob [36] to choose the Language.
- Confirm the select – press the Right Knob [36].



Restore Factory Settings

Note: After Factory Settings restore, the settings stored in user memory are deleted.

To restore Factory Settings:

- Access to the Settings and Configuration Menu.
- Use the Right Knob [36] to highlight the Restore Factory Settings icon.



Figure 58

- Press the Right Knob [36]. The Restore Factory Settings Menu is shown on the display.
- Use the Right Knob [36] to highlight the Check Mark.

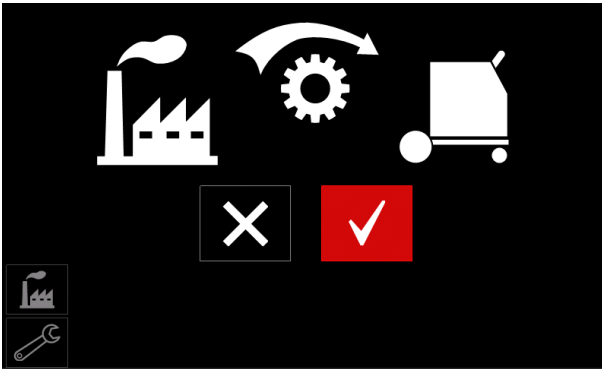

Figure 59

- Confirm the select – press the Right Button [36]. The factory settings are restored.



Diagnostic Information

Available information:

- Software Version
- Hardware Version
- Welding Software
- Ethernet IP Address
- Power Source Protocol
- Event Logs
- Fatal Logs.



Advanced setup

This menu enables access to the configuration parameters of the device.

To set the configuration parameters:

Access to the Settings and Configuration Menu.

Use the Right Knob [36] to highlight the "configuration menu" icon.



Figure 60

- Press the Right Knob [36]. The Configuration Menu is shown on the display.
- Use the Right Knob [36] to highlight the Parameter Number which will be changed, for example P.1 - allows change WFS units, factory default: "Metric" = m/min.

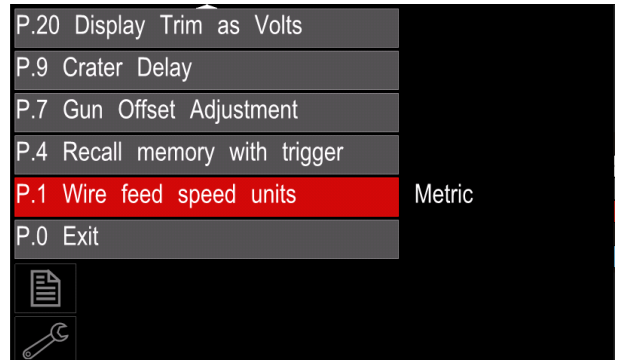

Figure 61

- Press the Right Knob [36].
- Use the Right Knob [36] to highlight the "English" = in/min.

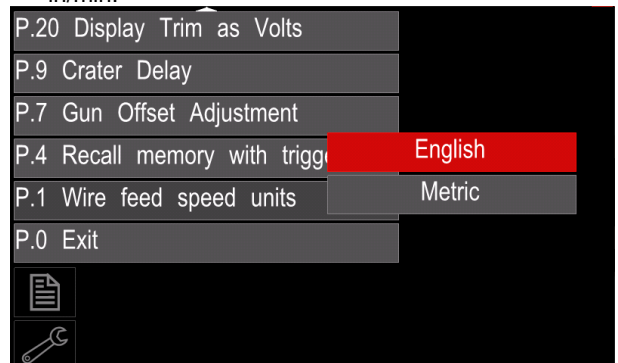

Figure 62

- Confirm the select – press the Right Button [36].

Table 15 The Configuration Parameters

P.0	The Menu Exit	Enables exit from menu
P.1	Wire Feed Speed (WFS) units	Enables change WFS units: <ul style="list-style-type: none"> • "Metric" (factory default) = m/min; • "English" = in/min.
P.4	Recall Memory with Trigger	This option allows a memory to be recalled by quickly pulling and releasing the gun trigger: <ul style="list-style-type: none"> • "Enable" = Selecting memories 2 through 9 by quickly pulling and releasing the gun trigger. To recall a memory with the gun trigger, quickly pull and release the trigger the number of times that correspond to the memory number. For example, to recall memory 3, quickly pull and release the trigger 3 times. Trigger memory recall can only be performed when the system is not welding. • "Disable" (factory default) = Memory selection is performed only by the Panel Buttons.
P.7	Gun Offset Adjustment	This option adjusts the wire feed speed calibration of the pull motor of a push-pull gun. This should only be performed when other possible corrections do not solve any push-pull feeding problems. An rpm meter is required to perform the pull gun motor offset calibration. To perform the calibration procedure do the following: <ol style="list-style-type: none"> 1. Release the pressure arm on both the pull and push wire drives. 2. Set the wire feed speed to 200 ipm. 3. Remove wire from the pull wire drive. 4. Hold an rpm meter to the drive roll in the pull gun. 5. Pull the trigger on the push-pull gun. 6. Measure the rpm of the pull motor. The rpm should be between 115 and 125 rpm. If necessary, decrease the calibration setting to slow the pull motor, or increase the calibration setting to speed up the motor. <ul style="list-style-type: none"> • The calibration range is -30 to +30, with 0 as the default value.
P.9	Crater Delay	This option is used to skip the Crater sequence when making short tack welds. If the trigger is released before the timer expires, Crater will be bypassed and the weld will end. If the trigger is released after the timer expires, the Crater sequence will function normally (if enabled). <ul style="list-style-type: none"> • OFF (0) to 10.0 seconds (default = Off)
P.20	Display Trim as Volts Option	Determines how trim is displayed <ul style="list-style-type: none"> • "No" (factory default) = The trim is displayed in the format defined in the weld set. • "Yes" = All trim values are displayed as a voltage. Note: This option may not be available on all machines. The power source must support this functionality, or this option will not appear in the menu.
P.22	Arc Start/Loss Error Time	This option can be used to optionally shut off output if an arc is not established, or is lost for a specified amount of time. Error 269 will be displayed if the machine times out. If the value is set to OFF, machine output will not be turned off if an arc is not established nor will output be turned off if an arc is lost. The trigger can be used to hot feed the wire (default). If a value is set, the machine output will shut off if an arc is not established within the specified amount of time after the trigger is pulled or if the trigger remains pulled after an arc is lost. To prevent nuisance errors, set Arc Start/Loss Error Time to an appropriate value after considering all welding parameters (run-in wire feed speed, weld wire feed speed, electrical stick out, etc). To prevent subsequent changes to Arc Start/Loss Error Time, the setup menu should be locked out by setting Preference Lock = Yes using the Power Wave Manager software. Note: This parameter is disabled while welding in Stick, TIG or Gouge.
P.28	Display Workpoint as Amps Option	Determines how workpoint is displayed: <ul style="list-style-type: none"> • "No" (factory default) = The workpoint is displayed in the format defined in the weld set. • "Yes" = All workpoint values are displayed as an amperage. Note: This option may not be available on all machines. The power source must support this functionality, or this option will not appear in the menu
P.80	Sense From Studs	Use this option for diagnostic purposes only. When power is cycled, this option is automatically reset to False. <ul style="list-style-type: none"> • "False" (default) = Voltage sensing is automatically determined by the selected weld mode and other machine settings. • "True" = Voltage sensing is forced to "studs" of the power source.

P.81	Electrode Polarity	Used in place of DIP switches for configuration of the work and electrode sense leads <ul style="list-style-type: none"> • "Positive" (default) = Most GMAW welding procedures use Electrode Positive welding. • "Negative" = Most GTAW and some inner shield procedures use Electrode Negative welding.
P.99	Show Test Modes	Uses for calibration and tests. <ul style="list-style-type: none"> • "No" (factory default) = Turned off; • "Yes" = Allows to selection test modes. Note: After the device has been restarted the P.99 is "NO".
P.323	System Update	This parameter is active only when the USB Memory Stick (with upgrade file) is connected to USB socket. <ul style="list-style-type: none"> • Cancel – goes back to Configuration Parameters menu • Accept – starts updating process



Service Menu

It allows the access to special service functions.

! WARNING

Service Menu is available when USB storage device is connected.

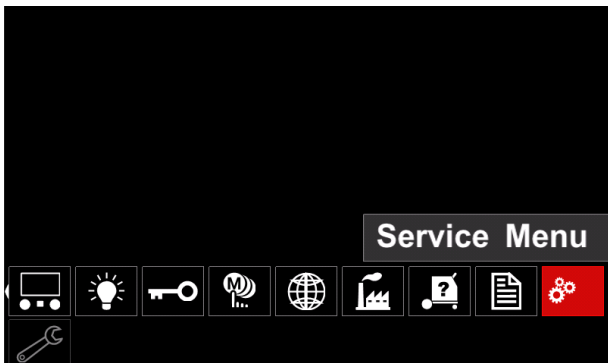





Figure 63

Table 16.

Symbol	Description
	Service weld logs
	Weld History
	SnapShot



Service weld logs – allows recording welding parameters which were using during the welding.

To access the menu:

- Make sure that USB device is connected to welding machine
- Access to the Settings and Configuration Menu.
- Use the Right Knob [36] to highlight the Service Menu icon
- Press the Right Knob [36] – the recording process will started.



Figure 64

- Press the Right Knob [36] to continue.

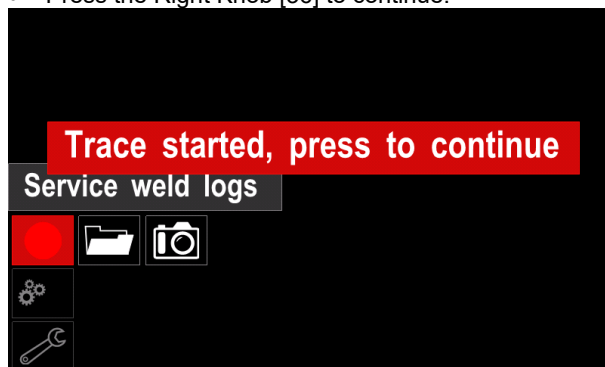

Figure 65

- Press the Left Knob [35] or Button [37] to exit
- Recording icon will appear on the Status bar [38].



Note: To stop the recording go to Service Menu and press the **Service weld logs** icon again



Weld history – after recording, welding parameters are saved into the USB device folder. To access the Welding history:

- Make sure that USB device is connected.
- Access to the Settings and Configuration Menu.
- Go to *Service Menu* → *Weld History*

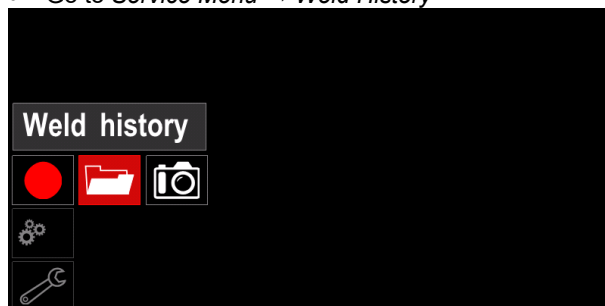

Figure 66

- Press the Right Knob [36] to get access of *Weld history* – the list of used parameters:
 - Weld number
 - Average WFS
 - Average current [A]
 - Average voltage [V]
 - Arc time [s]
 - Welding program number
 - Job number/name



SnapShot - create a file that contains detailed configuration and debugging information collected from each module in the POWERTEC® i250C/ i320C Advanced.

This file can be sent to Lincoln Electric Support to troubleshoot any possible issues that cannot be easily resolved by the user.

To obtain a SnapShot:

- Make sure that USB device is connected.
- Go to Configuration → Service Menu → Snapshot



Figure 67.

- Press the Right Knob [36] to start Snapshot process.

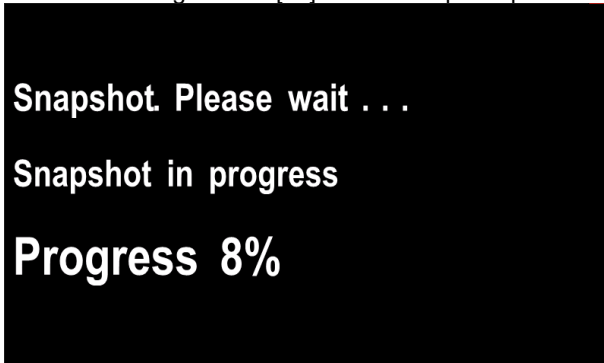

Figure 68.

Welding GMAW and FCAW Process in non-synergic mode

During non-synergic mode wire feed speed and welding voltage are independent parameters and must be set by the user.

Procedure of begin welding of GMAW or FCAW-SS process:

- Determine the wire polarity for the wire to be used. Consult the wire data for this information.
- Connect output the gas-cooled gun to GMAW / FCAW process to Euro Socket [5].
- Depending on the using wire, connect the work lead [15] to output socket [3] or [4]. See [20] point – terminal block of changing polarity.
- Connect the work lead [15] to the welding piece with the work clamp.
- Install the proper wire.
- Install the proper drive roll.
- Make a sure if it is needed (GMAW process), that the gas shield has been connected.
- Turn the machine on.
- Push the gun trigger to feed the wire through the gun liner until the wire comes out of the threaded end.
- Install a proper contact tip.
- Depending on the welding process and the type of the gun, install the nozzle (GMAW process) or protection cap (FCAW process).
- Close the Left side panel.
- The welding machine is now ready to weld.
- By applying the principle of occupational health and safety at welding, welding can be begun.

WARNING

Keep the gun cable as straight as possible when loading electrode through cable.

WARNING

Never use defected gun.

- Check gas flow with Gas Purge Switch [18].
- Close the wire drive door.
- Close the spool wire case.
- Select the Right welding program.
Note: The list of available programs depends on the power source.
- Set the welding parameters.
- The welding machine is now ready to weld.

WARNING

The wire drive door and wire spool case have to be completely closed during welding.

WARNING

Keep the gun cable as straight as possible when welding or loading electrode through cable.

WARNING

Do not kink or pull cable around sharp corners.

- By applying the principle of occupational health and safety at welding, welding can be begun.

For non-synergic mode can set:

- Wire Feed Speed, WFS
- The welding voltage
- Burnback Time
- Run-in WFS
- Preflow Time/ Postflow Time
- Spot Time
- 2-Step/4-Step
- Start Procedure
- Crater Procedure
- Wave Control:
 - Pinch

Welding GMAW and FCAW Process in synergic mode CV

In synergic mode, the welding voltage is not set by user. The correct welding voltage will set by the machine's software.

This value was recalled on the basis of data (input data) had been loaded:

- Wire Feed Speed, WFS.

If it is needed, the welding voltage can be adjusted by the Right Control [36]. When the Right Control is rotated, the display will show a positive or negative bar indicates if the voltage is above or below the ideal voltage.

Additionally can manually set:

- Burnback
- Run-In WFS
- Preflow Time/ Postflow Time
- Spot Time
- 2-Step/4-Step
- Start Procedure (Advanced only)
- Crater Procedure
- Wave Control:
 - Pinch

Welding SMAW Process

POWERTEC® i250C/i320C STANDARD/ ADVANCED does not include the electrode holder with lead necessary for SMAW welding, but the one can be purchased separately.

Procedure of begin welding of SMAW process:

- First turn the machine off.
- Determine the electrode polarity for the electrode to be used. Consult the electrode data for this information.
- Depending on the polarity of using electrode, connect the work lead [15] and the electrode holder with lead to output socket [3] or [4] and lock them. See the Table 17.

Table 17.

POLARITY			Output Socket	
DC (+)	The electrode holder with lead to SMAW		[4]	+
		Work lead	[3]	-
DC (-)	The electrode holder with lead to SMAW		[3]	-
		Work lead	[4]	+

- Connect the work lead to the welding piece with the work clamp.
- Install the proper electrode in the electrode holder.
- Turn the input power ON.
- Set the SMAW welding program.
- Set the welding parameters.
- The welding machine is now ready to weld.
- By applying the principle of occupational health and safety at welding, welding can be begun.

For SMAW program can set:

- Welding current
- Switch on / switch off the output voltage on the output lead
- Wave Controls:
 - ARC FORCE
 - HOT START

Loading the Electrode Wire

- Turn the machine off.
- Open the Right panel of the machine.
- Unscrew the locking nut of the sleeve.
- Load the spool with the wire on the sleeve such that the spool turns anticlockwise when the wire is fed into the wire feeder.
- Make sure that the spool locating pin goes into the fitting hole on the spool.
- Screw in the fastening cap of the sleeve.
- Put on the wire roll using the correct groove corresponding to the wire diameter.
- Free the end of the wire and cut off the bent end making sure it has no burr.

WARNING

Sharp end of the wire can hurt.

- Rotate the wire spool anticlockwise and thread the end of the wire into the wire feeder as far as the Euro socket.
- Adjust force of pressure roll of the wire feeder properly.

Adjustments of Brake Torque of Sleeve

To avoid spontaneous unrolling of the welding wire the sleeve is fitted with a brake.

Adjustment is carried by rotation of its Allen screw M8, which is placed inside of the sleeve frame after unscrewing the fastening cap of the sleeve.

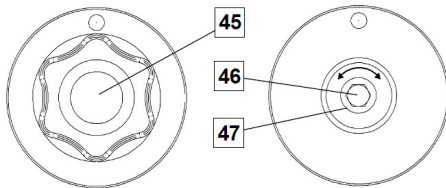

Figure 69.

- 45. Fastening cap.
- 46. Adjusting Allen screw M8.
- 47. Pressing spring.

Turning the Allen screw M8 clockwise increases the spring tension and you can increase the brake torque. Turning the Allen screw M8 anticlockwise decreases the spring tension and you can decrease the brake torque.

After finishing of adjustment, you should screw in the fastening cap again.

Adjusting of Pressure Roll Force

The pressure arm controls the amount of force the drive rolls exert on the wire.

Pressure force is adjusted by turning the adjustment nut clockwise to increase force, counterclockwise to decrease force. Proper adjustment of pressure arm gives the best welding performance.

WARNING

If the roll pressure is too low the roll will slide on the wire. If the roll pressure is set too high the wire may be deformed, which will cause feeding problems in the welding gun. The pressure force should be set properly. Decrease the pressure force slowly until the wire just begins to slide on the drive roll and then increase the force slightly by turning of the adjustment nut by one turn.

Inserting Electrode Wire into Welding Torch

- Turn the welding machine off.
- Depending on welding process, connect the proper gun to the euro socket, the rated parameters of the gun and of the welding machine should be matched.
- Remote the nozzle from the gun and contact tip or protection cap and contact tip. Next, straighten the gun out flat.
- Turn the welding machine on.
- Hold the Cold Inch/Gas Purge Switch in the Cold Inch position.
- When the switch is released spool of wire should not unwind.
- Adjust wire spool brake accordingly.
- Turn the welding machine off.
- Install a proper contact tip.
- Depending on the welding process and the type of the gun, install the nozzle (GMAW process) or protection cap (FCAW process).

WARNING

Take precaution to keep eyes and hands away from the end of the gun while the wire is being come out of the threatened end.

Changing Driving Rolls

WARNING

Turn the input power off before installation or changing drive rolls.

POWERTEC®i250C STANDARD / ADVANCED, POWERTEC® i320C STANDARD / ADVANCED is equipped with drive roll V1.0/V1.2 for steel wire. For others wire sizes, is available the proper drive rolls kit (see "Accessories" chapter) and follow instructions:

- Turn the input power OFF.
- Unlock 4 rolls by turning 4 Quick-Change Carrier Gear [52].
- Release the pressure roll levers [53].
- Change the drive rolls [51] with the compatible ones corresponding to the used wire.

WARNING

Be sure that the gun liner and contact tip are also sized to match the selected wire size.

WARNING

For wires with the diameter larger than 1.6mm, the following parts are to be changed:

- The guide tube of the feeding console [49] and [50].
 - The guide tube of the Euro Socket [48].
-
- Lock 4 new rolls by turning 4 Quick-Change Carrier Gear [52].
 - Manually feed the wire from the wire reel, the wire through the guide tubes, over the roller and through the guide tube of Euro Socket into liner of gun.
 - Lock the pressure roll levers [53].

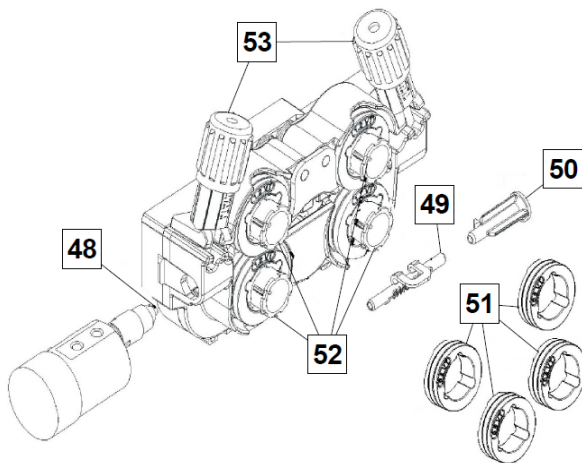

Figure 70.

Gas Connection

A gas cylinder must be installed with a proper flow regulator. Once a gas cylinder with a flow regulator has been securely installed, connect the gas hose from the regulator to the machine gas inlet connector.

WARNING

The welding machine supports all suitable shielding gases including carbon dioxide, argon and helium at a maximum pressure of 5,0 bars.

WARNING

Always fasten gas cylinder properly in vertical position in a special holder on the wall or on a carriage. Remember to close gas cylinder valve after having finished welding.

WARNING

Gas cylinder can be fasten on the machine's shelf, but the height of gas cylinder doesn't have to be higher than 43in/1,1m. The gas cylinder which is fastened on the machine's shelf has to be secured by attaching it to the machine using the chain.

WARNING

Always fasten gas cylinder properly in vertical position in a special holder on the wall or on a carriage. Remember to close gas cylinder valve after having finished welding.

WARNING

Gas cylinder can be fasten on the machine's shelf, but the height of gas cylinder doesn't have to be higher than 43in/1,1m. The gas cylinder which is fastened on the machine's shelf has to be secured by attaching it to the machine using the chain.

Maintenance

WARNING

For any repair operations, modifications or maintenance, it is recommended to contact the nearest Technical Service Center or Lincoln Electric. Repairs and modifications performed by unauthorized service or personnel will cause the manufacturer's warranty to become null and void.

Any noticeable damage should be reported immediately and repaired.

Routine maintenance (everyday)

- Check condition of insulation and connections of the work leads and insulation of power lead. If any insulation damage exists replace the lead immediately.
- Remove the spatters from the welding gun nozzle. Spatters could interfere with the shielding gas flow to the arc.
- Check the welding gun condition: replace it, if necessary.
- Check condition and operation of the cooling fan. Keep clean its airflow slots.

Periodic maintenance (every 200 working hours but at least once a year)

Perform the routine maintenance and, in addition:

- Keep the machine clean. Using a dry (and low pressure) airflow, remove the dust from the external case and from the cabinet inside.
- If it is required, clean and tighten all weld terminals.

The frequency of the maintenance operations may vary in accordance with the working environment where the machine is placed.

WARNING

Do not touch electrically live parts.

WARNING

Before the case of machine will be removed, the machine has to be turned off and the power lead has to be disconnected from mains socket.

WARNING

Mains supply network must be disconnected from the machine before each maintenance and service. After each repair, perform proper tests to ensure safety.

Customer Assistance Policy

The business of The Lincoln Electric Company is manufacturing and selling high quality welding equipment, consumables, and cutting equipment. Our challenge is to meet the needs of our customers and to exceed their expectations. On occasion, purchasers may ask Lincoln Electric for advice or information about their use of our products. We respond to our customers based on the best information in our possession at that time. Lincoln Electric is not in a position to warrant or guarantee such advice, and assumes no liability, with respect to such information or advice. We expressly disclaim any warranty of any kind, including any warranty of fitness for any customer's particular purpose, with respect to such information or advice. As a matter of practical consideration, we also cannot assume any responsibility for updating or correcting any such information or advice once it has been given, nor does the provision of information or advice create, expand or alter any warranty with respect to the sale of our products.

Lincoln Electric is a responsive manufacturer, but the selection and use of specific products sold by Lincoln Electric is solely within the control of, and remains the sole responsibility of the customer. Many variables beyond the control of Lincoln Electric affect the results obtained in applying these types of fabrication methods and service requirements.

Subject to Change – This information is accurate to the best of our knowledge at the time of printing. Please refer to www.lincolnelectric.com for any updated information.

WEEE

07/06

English



Do not dispose of electrical equipment together with normal waste!

In observance of European Directive 2012/19/EC on Waste Electrical and Electronic Equipment (WEEE) and its implementation in accordance with national law, electrical equipment that has reached the end of its life must be collected separately and returned to an environmentally compatible recycling facility. As the owner of the equipment, you should get information on approved collection systems from our local representative. By applying this European Directive you will protect the environment and human health!

Spare Parts

12/05

Part List reading instructions

- Do not use this part list for a machine if its code number is not listed. Contact the Lincoln Electric Service Department for any code number not listed.
- Use the illustration of assembly page and the table below to determine where the part is located for your particular code machine.
- Use only the parts marked "X" in the column under the heading number called for in the assembly page (# indicate a change in this printing).

First, read the Part List reading instructions above, then refer to the "Spare Part" manual supplied with the machine, that contains a picture-descriptive part number cross-reference.

REACH

11/19

Communication in accordance with Article 33.1 of Regulation (EC) No 1907/2006 – REACH.

Some parts inside this product contain:

Bisphenol A, BPA,	EC 201-245-8, CAS 80-05-7
Cadmium,	EC 231-152-8, CAS 7440-43-9
Lead,	EC 231-100-4, CAS 7439-92-1
Phenol, 4-nonyl-, branched,	EC 284-325-5, CAS 84852-15-3

in more than 0,1% w/w in homogeneous material. These substances are included in the "Candidate List of Substances of Very High Concern for Authorisation" of REACH.

Your particular product may contain one or more of the listed substances.

Instructions for safe use:

- use according to Manufacturer instructions, wash hands after use;
- keep out of reach of children, do not put in mouth,
- dispose in accordance with local regulations.

Authorized Service Shops Location

09/16

- The purchaser must contact a Lincoln Authorized Service Facility (LASF) about any defect claimed under Lincoln's warranty period.
- Contact your local Lincoln Sales Representative for assistance in locating a LASF or go to www.lincolnelectric.com/en-gb/Support/Locator.

Electrical Schematic

Refer to the "Spare Part" manual supplied with the machine.

Accessories

K10095-1-15M	REMOTE CONTROL
K2909-1	6-PIN/12-PIN ADAPTER
K14172-1	12PIN REMOTE CONTROL KIT (PTI250C/I320C ADV)
K14173-1	POLARITY CHANGE KIT (PTI250C/I320C STD/ADV)
K14174-1	CONTROL PANEL COVER KIT (PTI250C/I320C STD/ADV)
K14175-1	GAS FLOW METER KIT (PTI250C/I320C STD/ADV)
K14176-1	GAS HEATER KIT (PTI250C/I320C STD/ADV)
K14177-1	BUMPERS KIT (PTI250C/I320C STD/ADV)
K10158-1	ADAPTER FOR SPOOL TYPE B300
K363P	ADAPTER FOR SPOOL TYPE READI-REEL®
K14091-1	REMOTE MIG LF45PWC300-7M (CS/PP)
K10413-360GC-4M	CROSS SWITCH GUN GAS COOLED 4M (335A 60%)
LINC GUN™	
W10429-24-3M	LGS2 240 G-3.0M MIG GUN AIR COOLED
W10429-24-4M	LGS2 240 G-4.0M MIG GUN AIR COOLED
W10429-24-5M	LGS2 240 G-5.0M MIG GUN AIR COOLED
W10429-25-3M	LGS2 250 G-3.0M MIG GUN AIR COOLED
W10429-25-4M	LGS2 250 G-4.0M MIG GUN AIR COOLED
W10429-25-5M	LGS2 250 G-5.0M MIG GUN AIR COOLED
W10429-36-3M	LGS2 360 G-3.0M MIG GUN AIR COOLED
W10429-36-4M	LGS2 360 G-4.0M MIG GUN AIR COOLED
W10429-36-5M	LGS2 360 G-5.0M MIG GUN AIR COOLED
ROLL KIT FOR SOLID WIRES	
KP14150-V06/08	ROLL KIT 0.6/0.8VT FI37 4PCS GREEN/BLUE
KP14150-V08/10	ROLL KIT 0.8/1.0VT FI37 4PCS BLUE/RED
KP14150-V10/12	ROLL KIT 1.0/1.2VT FI37 4PCS RED/ORANGE
KP14150-V12/16	ROLL KIT 1.2/1.6VT FI37 4PCS ORANGE/YELL
KP14150-V16/24	ROLL KIT 1.6/2.4VT FI37 4PCS YELL/GREY
KP14150-V09/11	ROLL KIT 0.9/1.1VT FI37 4PCS
KP14150-V14/20	ROLL KIT 1.4/2.0VT FI37 4PCS
ROLL KIT FOR ALUMINIUM WIRES	
KP14150-U06/08A	ROLL KIT 0.6/0.8AT FI37 4PCS GREEN/BLUE
KP14150-U08/10A	ROLL KIT 0.8/1.0AT FI37 4PCS BLUE/RED
KP14150-U10/12A	ROLL KIT 1.0/1.2AT FI37 4PCS RED/ORANGE
KP14150-U12/16A	ROLL KIT 1.2/1.6AT FI37 4PCS ORANGE/YELL
KP14150-U16/24A	ROLL KIT 1.6/2.4AT FI37 4PCS YELL/GREY
ROLL KIT FOR CORED WIRES	
KP14150-V12/16R	ROLL KIT 1.2/1.6RT FI37 4PCS ORANGE/YELL
KP14150-V14/20R	ROLL KIT 1.4/2.0RT FI37 4PCS
KP14150-V16/24R	ROLL KIT 1.6/2.4RT FI37 4PCS YELL/GREY
KP14150-V09/11R	ROLL KIT 0.9/1.1RT FI37 4PCS
KP14150-V10/12R	ROLL KIT 1.0/1.2RT FI37 4PCS -/ORANGE
WIRE GUIDES	
0744-000-318R	WIRE GUIDE SET BLUE Ø0.6-1.6
0744-000-319R	WIRE GUIDE SET RED Ø1.8-2.8
D-1829-066-4R	EURO WIRE GUIDE Ø0.6-1.6
D-1829-066-5R	EURO WIRE GUIDE Ø1.8-2.8