

PF44 & PF46

OPERATOR'S MANUAL



ENGLISH





THANKS! For having chosen the **QUALITY** of the Lincoln Electric products.

- Please Examine Package and Equipment for Damage. Claims for material damaged in shipment must be notified immediately to the dealer.
- For future reference record in the table below your equipment identification information. Model Name, Code & Serial Number can be found on the machine rating plate.

Model Name:
Code & Serial number:
Date & Where Purchased:

ENGLISH INDEX

Technical Specifications	1
Electromagnetic Compatibility (EMC)	2
Safety	3
Introduction	5
Installation and Operator Instructions	5
WEEE	49
Spare Parts	49
REACH	49
Authorized Service Shops Location	49
Electrical Schematic	49
Suggested Accessories	50
Connection Diagram	51

Technical Specifications

NAME		INDEX			
PF44		K14108-1			
PF46		K14109-1			
INPUT					
Input Voltage U ₁		Input Amperes I ₁		EMC Class	
40Vdc		4A		A	
RATED OUTPUT					
Duty Cycle 40°C (based on a 10 min. period)			Output Current		
100%			385A		
60%			500A		
OUTPUT RANGE					
Welding Current Range			Peak Open Circuit Voltage		
5 ÷ 500A			113Vdc or Vac peak		
DIMENSION					
Weight		Height		Width	Length
18,5 kg		460 mm		300 mm	640 mm
WIRE FEED SPEED RANGE / WIRE DIAMETER					
WFS Range	Drive Rolls	Drive roll diameter	Solid Wires	Aluminum Wires	Cored Wires
1 ÷ 22 m/min	4	Ø37	0.8 ÷ 1.6 mm	1.0 ÷ 1.6 mm	0.9 ÷ 1.6 mm
Protection Rating		Maximum Gas Pressure		Operating Temperature	
IP23		0,5MPa (5 bar)		from -10°C to +40°C	
				Storage Temperature	
				from -25°C to 55°C	

Electromagnetic Compatibility (EMC)

01/11

This machine has been designed in accordance with all relevant directives and standards. However, it may still generate electromagnetic disturbances that can affect other systems like telecommunications (telephone, radio, and television) or other safety systems. These disturbances can cause safety problems in the affected systems. Read and understand this section to eliminate or reduce the amount of electromagnetic disturbance generated by this machine.



This machine has been designed to operate in an industrial area. To operate in a domestic area it is necessary to observe particular precautions to eliminate possible electromagnetic disturbances. The operator must install and operate this equipment as described in this manual. If any electromagnetic disturbances are detected the operator must put in place corrective actions to eliminate these disturbances with, if necessary, assistance from Lincoln Electric.

Before installing the machine, the operator must check the work area for any devices that may malfunction because of electromagnetic disturbances. Consider the following.

- Input and output cables, control cables, and telephone cables that are in or adjacent to the work area and the machine.
- Radio and/or television transmitters and receivers. Computers or computer controlled equipment.
- Safety and control equipment for industrial processes. Equipment for calibration and measurement.
- Personal medical devices like pacemakers and hearing aids.
- Check the electromagnetic immunity for equipment operating in or near the work area. The operator must be sure that all equipment in the area is compatible. This may require additional protection measures.
- The dimensions of the work area to consider will depend on the construction of the area and other activities that are taking place.

Consider the following guidelines to reduce electromagnetic emissions from the machine.

- Connect the machine to the input supply according to this manual. If disturbances occur it may be necessary to take additional precautions such as filtering the input supply.
- The output cables should be kept as short as possible and should be positioned together. If possible connect the work piece to ground in order to reduce the electromagnetic emissions. The operator must check that connecting the work piece to ground does not cause problems or unsafe operating conditions for personnel and equipment.
- Shielding of cables in the work area can reduce electromagnetic emissions. This may be necessary for special applications.

WARNING

EMC classification of this product is class A in accordance with electromagnetic compatibility standard EN 60974-10 and therefore the product is designed to be used in an industrial environment only.

WARNING









The Class A equipment is not intended for use in residential locations where the electrical power is provided by the public low-voltage supply system. There may be potential difficulties in ensuring electromagnetic compatibility in those locations, due to conducted as well as radiated disturbances.









WARNING

This equipment must be used by qualified personnel. Be sure that all installation, operation, maintenance and repair procedures are performed only by qualified person. Read and understand this manual before operating this equipment. Failure to follow the instructions in this manual could cause serious personal injury, loss of life, or damage to this equipment. Read and understand the following explanations of the warning symbols. Lincoln Electric is not responsible for damages caused by improper installation, improper care or abnormal operation.

	<p>WARNING: This symbol indicates that instructions must be followed to avoid serious personal injury, loss of life, or damage to this equipment. Protect yourself and others from possible serious injury or death.</p>
	<p>READ AND UNDERSTAND INSTRUCTIONS: Read and understand this manual before operating this equipment. Arc welding can be hazardous. Failure to follow the instructions in this manual could cause serious personal injury, loss of life, or damage to this equipment.</p>
	<p>ELECTRIC SHOCK CAN KILL: Welding equipment generates high voltages. Do not touch the electrode, work clamp, or connected work pieces when this equipment is on. Insulate yourself from the electrode, work clamp, and connected work pieces.</p>
	<p>ELECTRICALLY POWERED EQUIPMENT: Turn off input power using the disconnect switch at the fuse box before working on this equipment. Ground this equipment in accordance with local electrical regulations.</p>
	<p>ELECTRICALLY POWERED EQUIPMENT: Regularly inspect the input, electrode, and work clamp cables. If any insulation damage exists replace the cable immediately. Do not place the electrode holder directly on the welding table or any other surface in contact with the work clamp to avoid the risk of accidental arc ignition.</p>
	<p>ELECTRIC AND MAGNETIC FIELDS MAY BE DANGEROUS: Electric current flowing through any conductor creates electric and magnetic fields (EMF). EMF fields may interfere with some pacemakers, and welders having a pacemaker shall consult their physician before operating this equipment.</p>
	<p>CE COMPLIANCE: This equipment complies with the European Community Directives.</p>
 <p>Optical radiation emission Category 2 (EN 12198)</p>	<p>ARTIFICIAL OPTICAL RADIATION: According with the requirements in 2006/25/EC Directive and EN 12198 Standard, the equipment is a category 2. It makes mandatory the adoption of Personal Protective Equipments (PPE) having filter with a protection degree up to a maximum of 15, as required by EN169 Standard.</p>
	<p>FUMES AND GASES CAN BE DANGEROUS: Welding may produce fumes and gases hazardous to health. Avoid breathing these fumes and gases. To avoid these dangers the operator must use enough ventilation or exhaust to keep fumes and gases away from the breathing zone.</p>
	<p>ARC RAYS CAN BURN: Use a shield with the proper filter and cover plates to protect your eyes from sparks and the rays of the arc when welding or observing. Use suitable clothing made from durable flame-resistant material to protect you skin and that of your helpers. Protect other nearby personnel with suitable, non-flammable screening and warn them not to watch the arc nor expose themselves to the arc.</p>

	<p>WELDING SPARKS CAN CAUSE FIRE OR EXPLOSION: Remove fire hazards from the welding area and have a fire extinguisher readily available. Welding sparks and hot materials from the welding process can easily go through small cracks and openings to adjacent areas. Do not weld on any tanks, drums, containers, or material until the proper steps have been taken to insure that no flammable or toxic vapors will be present. Never operate this equipment when flammable gases, vapors or liquid combustibles are present.</p>
	<p>WELDED MATERIALS CAN BURN: Welding generates a large amount of heat. Hot surfaces and materials in work area can cause serious burns. Use gloves and pliers when touching or moving materials in the work area.</p>
	<p>CYLINDER MAY EXPLODE IF DAMAGED: Use only compressed gas cylinders containing the correct shielding gas for the process used and properly operating regulators designed for the gas and pressure used. Always keep cylinders in an upright position securely chained to a fixed support. Do not move or transport gas cylinders with the protection cap removed. Do not allow the electrode, electrode holder, work clamp or any other electrically live part to touch a gas cylinder. Gas cylinders must be located away from areas where they may be subjected to physical damage or the welding process including sparks and heat sources.</p>
	<p>MOVING PARTS ARE DANGEROUS: There are moving mechanical parts in this machine, which can cause serious injury. Keep your hands, body and clothing away from those parts during machine starting, operating and servicing.</p>
	<p>SAFETY MARK: This equipment is suitable for supplying power for welding operations carried out in an environment with increased hazard of electric shock.</p>

The manufacturer reserves the right to make changes and/or improvements in design without upgrade at the same time the operator's manual.

Introduction

PF44 and PF46 are digital wire feeders which have been designed to work with all Lincoln Electric power sources using ArcLink® protocol to communication.

Digital wire feeders allow the welding:

- GMAW (MIG/MAG)
- FCAW-GS / FCAW-SS
- SMAW (MMA)
- GTAW (arc ignition using lift TIG)

Recommended equipment, which can be bought by user, was mentioned in the chapter " Suggested Accessories ".

Installation and Operator Instructions

Read this entire section before installation or operation of the machine.

Location and Environment

This machine will operate in harsh environments. However, it is important that simple preventative measures are followed to assure long life and reliable operation.

- Do not place or operate this machine on a surface with an incline greater than 15° from horizontal.
- Do not use this machine for pipe thawing.
- This machine must be located where there is free circulation of clean air without restrictions for air movement.
- Dirt and dust that can be drawn into the machine should be kept to a minimum.
- This machine has a protection rating of IP23. Keep it dry when possible and do not place it on wet ground or in puddles.
- Locate the machine away from radio controlled machinery. Normal operation may adversely affect the operation of nearby radio controlled machinery, which may result in injury or equipment damage. Read the section on electromagnetic compatibility in this manual.
- Do not operate in areas with an ambient temperature greater than 40°C.

Duty cycle and Overheating

The duty cycle of a welding machine is the percentage of time in a 10 minute cycle at which the welder can operate the machine at rated welding current.

Example: 60% duty cycle



Welding for 6 minutes.

Break for 4 minutes.

Excessive extension of the duty cycle will cause the thermal protection circuit to activate.

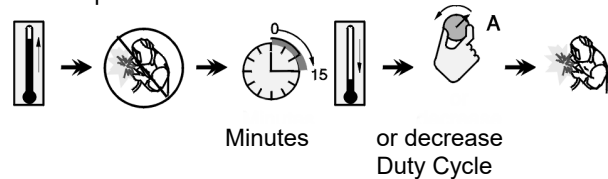

Minutes

or decrease
Duty Cycle

Input Supply Connection

Check the input voltage, phase, and frequency of the power source that will be connected to this wire feeder. The allowable input voltage source is indicated on the rating plate of the wire feeder. Verify the connection of grounding wires from the power source to the input source.

Controls and Operational Features

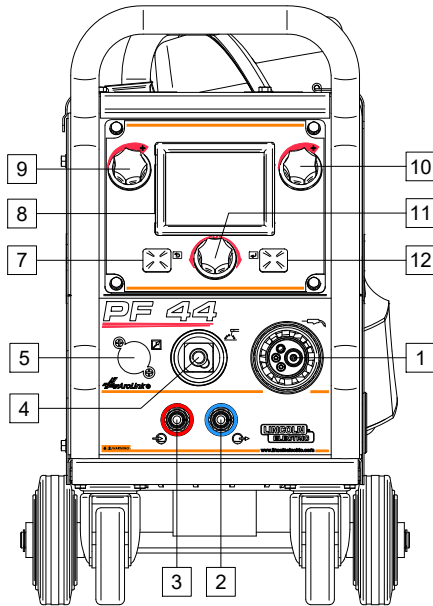

Figure 1

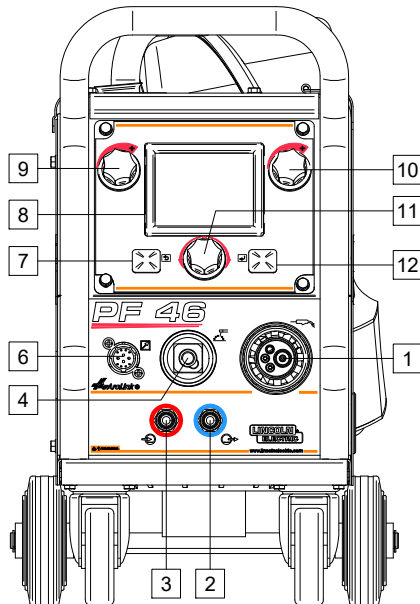







Figure 2.

-  1. EURO Socket: For connecting a welding gun (for GMAW / FCAW-SS process).
-  2. Quick Connect Coupling: Coolant outlet (supplies cool coolant to the gun).
-  3. Quick Connect Coupling: Coolant inlet (takes warm coolant from the gun).

WARNING

Maximum coolant pressure is 5,0 bar.

-  4. Output Socket for the Welding Circuit: For connecting an electrode holder with lead.

-  5. Remote Control Connector Plug (optional, PF44 only): To install Remote Control Kit. It can be purchased separately. See "Accessories" chapter.

-  6. Remote Control Receptacle (PF46 only): To connection Remote Control or Cross Switch Gun.

-  7. Left Button:
 - Cancel
 - Back.

- 8. Display: Parameters of welding process are shown.

- 9. Left Control: The value of the parameter in the upper left side of display [8] is adjusted.

- 10. Right Control: The value of the parameter in the upper right side of display [8] is adjusted.

- 11. Set Control: Type of welding procedure and welding settings is changed by this Control.

-  12. Right Button: Confirm change.

-  13. Gas Connector: Connection for gas line.

WARNING

The welding machine supports all suitable shielding gases at a maximum pressure of 5,0 bar.

-  14. Control Receptacle: 5 pins receptacle for wire feeder connection. To communication wire feeder with power source is used ArLink® protocol.

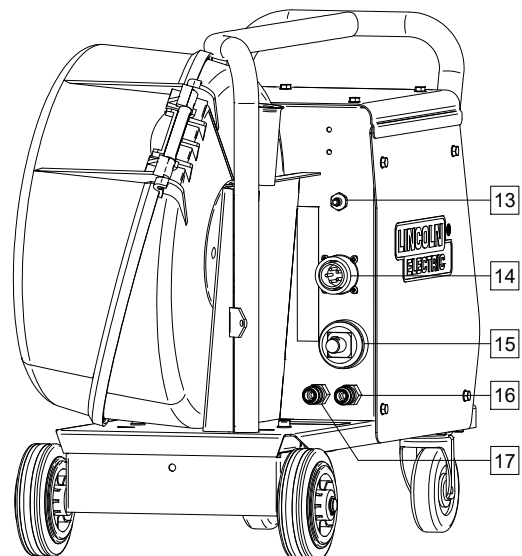



Figure 3.

-  15. Current Socket: Input power connection.

-  16. Quick Connect Coupling: Coolant outlet (takes warm coolant from welding machines to cooler).

-  17. Quick Connect Coupling: Coolant inlet (supplies cool coolant from cooler to the welding machines).

! WARNING

Maximum coolant pressure is 5,0 bar.

To ensure failure-free work and right flow of coolant, use only coolant that is recommended by the manufacturer of welding gun or cooler.

- 18. Gas Flow Regulator Plug: Gas Flow Regulator can be purchased separately. See "Accessories" chapter.
- 19. Cold Inch / Gas Purge Switch: This switch enables wire feeding or gas flow without turning on output voltage.
- 20. Lighting Switch.
- 21. USB Receptacle: To connection the USB memory.

! WARNING

Be sure that wire spool case has to be completely closed during welding.

- 23. Spooled Wire: The machine does not include a spooled wire.

- 24. Wire Drive: 4-Roll wire drive.

! WARNING

The wire drive door and wire spool case have to be completely closed during welding.

! WARNING

Not use handle to move the machine during work. See "Accessories" chapter.

PF 44

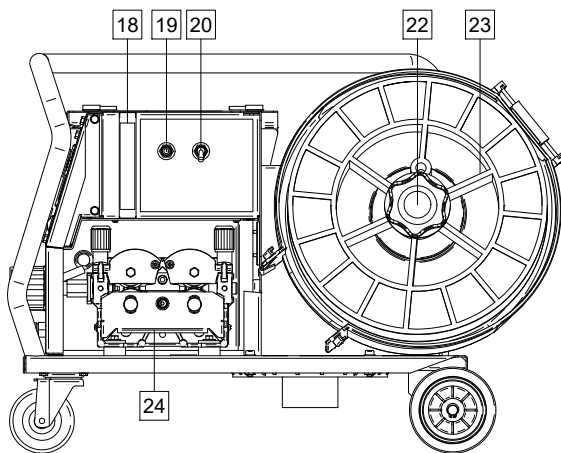

Figure 4.

PF 46

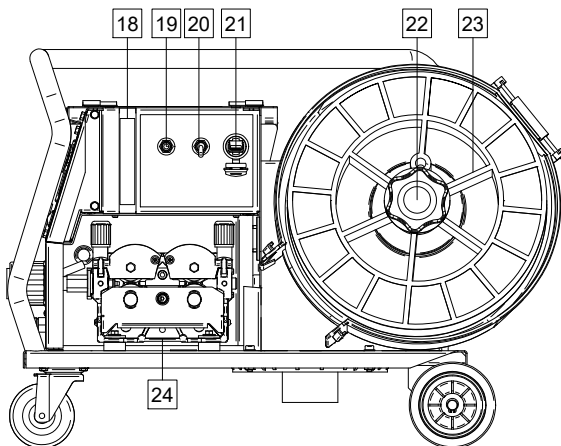

Figure 5.



















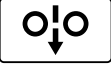

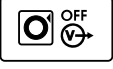

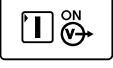

- 22. Wire Spool Support: Maximum 15kg spools. Accepts plastic, steel and fiber spools onto 51mm spindle. Also accepts Readi-Reel® type spools onto included spindle adapter.

Guide's Marking Interface

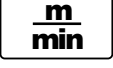
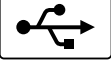
Description of the abridged user interface in "Quick Guide" chapter. See "Spare Part".

Table 1. Symbols description

	Select Welding Process		SMAW-Soft Process		Memory (PF46 only)
	Select Welding Program		SMAW-Crisp Process		Save to the User Memory (PF46 only)
	Non-synergic Programs		SMAW-Pipe Process		Recall from the User Memory (PF46 only)
	Synergic Programs		Gouging		Arc Force
	GMAW Process (MIG/MAG)		Electrode Wire Type Selection		Hot Start
	GMAW Process – POWER MODE®		Wire Size (diameter) Selection		Frequency Settings (GTAW-PULSE)
	FCAW Process		Gas Selection		Frequency (GTAW-PULSE)
	FCAW-SS Process		User Settings		Background Settings (GTAW-PULSE)
	FCAW-GS Process		Pinch		Background Current (GTAW-PULSE)
	GMAW-P Process		Select Function of Gun Trigger (2-Step / 4-Step)		Background Current (STT®)
	GMAW-P Process RapidArc® Program		2-Step		Peak Current (STT®)
	GMAW-P Process RapidX® Program		4-Step		TailOut (STT®)
	GMAW-P process Precision Pulse™ Program		Prewflow Time		UltimArc™
	GMAW-P Process Pulse-On-Pulse® Program		Postflow Time		Setting and Configuration Menu
	STT® Process		Burnback Time		Memory Limits (PF46 only)
	GTAW Process (TIG)		Run-in WFS		Display Configuration Settings
	GTAW Welding		Spot Welding Settings		Big Meters Menu (factory default)
	GTAW-PULSE Welding		Spot Timer		Standard Menu
	GTAW Program		Start Procedure		Weld Score™ Menu
	GTAW-PULSE Program		Crater Procedure		True Energy™ Menu
	SMAW Process (MMA)		A/B Procedure (PF46 only)		Assign Function to the Right Button

	Disabled		Restore Factory Setting		Trim
	Check Mark		View Software and Hardware Version Information		Power in kW
	Resignation Mark		Setup Menu		Cold Feed
	Wave Controls		Switch Off Output Voltage (MMA/TIG only)		Gas Purge
	Brightness Level		Switch On Output Voltage (MMA/TIG only)		Error
	Lock / Unlock		Welding Current		USB Memory (PF46 only)
	Locked		Wire Feed Speed in [m/min]		USB Memory is connected (PF46 only)
	Unlocked		Wire Feed Speed in [in/min]		ESCape Button
	Set Passcode		Welding Voltage		Confirm Button

Interface Description

Table 2. Interface Components and Functions

Functions of Interface Components	
<p>The diagram shows a welding control interface with the following components labeled:</p> <ul style="list-style-type: none"> 7: Cancel / back button (left) 9: Changing Parameter Value [25] dial (top left) 10: Changing Parameter Value [26] dial (top right) 11: Selection and changing the Welding Settings dial (bottom center) 12: Change Confirmation button (right) 25: The Parameter Value in the upper left side of display (5.51 m/min) 26: The Parameter Value in the upper right side of display (28.6 V) 27: Welding Parameters Bar (bottom of display) 28: Welding Program (21) 	<p>7. Cancel / back.</p> <p>9. Changing Parameter Value [25].</p> <p>10. Changing Parameter Value [26].</p> <p>11. Selection and changing the Welding Settings.</p> <p>12. Change Confirmation.</p> <p>25. The Parameter Value in the upper left side of display.</p> <p>26. The Parameter Value in the upper right side of display.</p> <p>27. Welding Parameters Bar.</p> <p>28. Welding Program.</p>

Figure 6.

Welding Parameters Bar

The Welding Parameters Bar enables:

- Welding Program change.
- Wave Control Value change.
- The gun's trigger function change (GMAW, GMAW-P, FCAW, STT, GTAW only).
- Add or hide functions and welding parameters – User Settings

Table 3. SMAW Welding Parameters Bar – factory default





	Welding Process Choice
	Arc Force
	Hot Start (SMAW Soft and SMAW Crisp only)
	User Settings

Table 4. Gouging Welding Parameters Bar – factory default

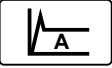

	Welding Process Choice
	User Settings

Table 5. GTAW Welding Parameters Bar – factory default





	Welding Process Choice
	Hot Start
	The function of the gun's trigger change
	User Settings

Table 6. GTAW-P Welding Parameters Bar – factory default





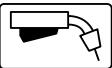

	Welding Process Choice
	Frequency Settings
	Background Settings
	Hot Start
	The function of the gun's trigger change
	User Settings

Table 7. GMAW and FCAW Welding Parameters Bar – factory default

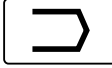

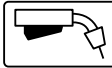

	Welding Process Choice
	Pinch *
	Hot Start
	The function of the gun's trigger change
	User Settings

Table 8. GMAW-P Welding Parameters Bar – factory default



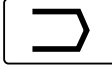

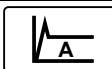
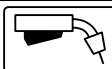
	Welding Process Choice
	Frequency (Pulse-On-Pulse® only)
	UltimArc™ (except for Pulse-On-Pulse®)
	The function of the gun's trigger change
	User Settings

Table 9. Non-synergic STT® Welding Parameters Bar – factory settings





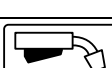





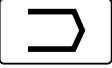

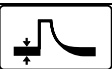
	Welding Process Choice
	Peak Current
	Background Current
	TailOut
	Hot Start
	The function of the gun's trigger change
	User Settings

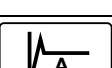
Table 10. Synergic STT® Welding Parameters Bar – factory settings

	Welding Process Choice
	UltimArc™
	Hot Start
	The function of the gun's trigger change
	User Settings

Welding Program Choice

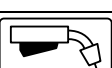
To select the Welding Program:

- Use the Set Control [11] to highlight the Welding Process Choice icon.

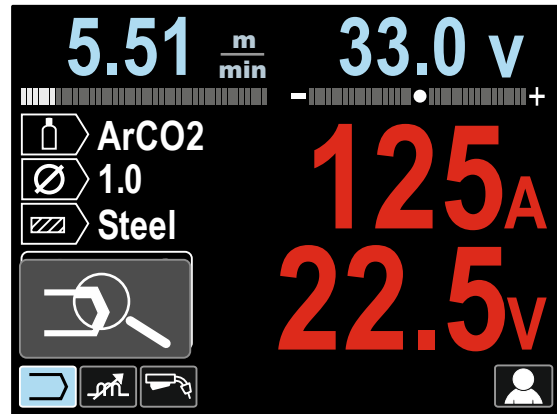

Figure 7.

- Press the Set Control [11] – Welding Program Choice Menu is shown on the display.

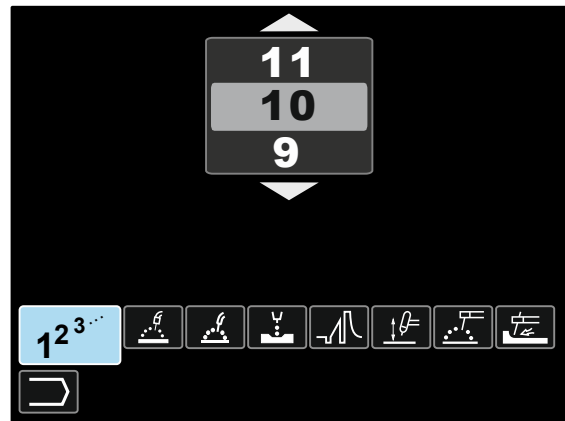

Figure 8.

- Use the Set Control [11] to highlight the Welding Program Choice icon – Figure 8.
- Press the Set Control [11].
- Use the Set Control [11] to highlight the Welding Program Number.

Note: The list of available programs depends on the power source.

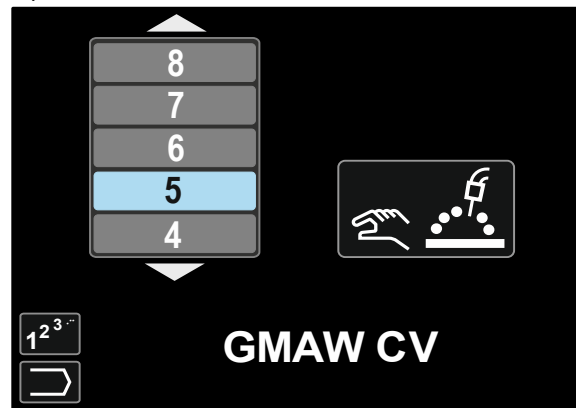
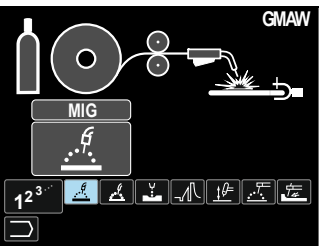
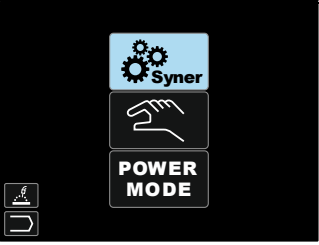
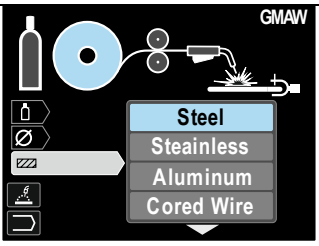
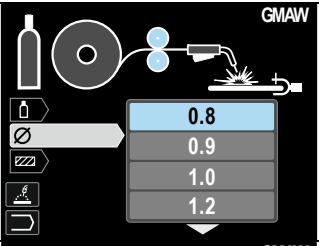
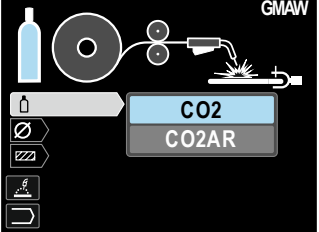

Figure 9.

- Confirm the select – press the Right Button [12].

If a user does not know the Welding Program Number, it can be searched. In that case in subsequent steps are given:

<ul style="list-style-type: none"> The Welding Process 	
<ul style="list-style-type: none"> Synergic / Non-synergic Process 	
<ul style="list-style-type: none"> The Electrode Wire Type 	
<ul style="list-style-type: none"> The Electrode Wire Diameter 	
<ul style="list-style-type: none"> The Shielding Gas 	

In consequence the definite Welding Program is received.

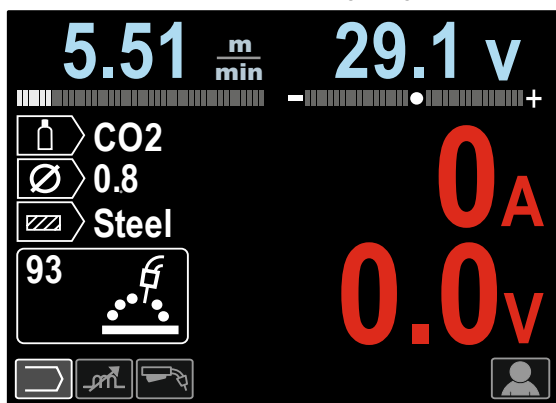

Figure 10









User Settings

To access the User Settings, mark the User Settings icon [11], press and hold for 1 second the Right Button [12].



Figure 11.

The User Setting Menu enables to add the additional function and / or parameters to the Welding Parameters Bar [27]. Depending on the Wire Feeder, may be added:

Icon	Parameter	PF44	PF46
	Preflow	✓	✓
	Postflow	✓	✓
	Burnback Time	✓	✓
	Spot Welding	✓	✓
	Run-In WFS	✓	✓
	Start Procedure	✓	✓
	Crater Procedure	✓	✓
	A/B Procedure	-	✓
	User Memory	-	✓

Note: To change the Parameters or Functions Value, theirs icons had to be added to the Welding Parameters Bar [27].

To add the Parameter or Function to the Welding Parameters Bar [27]:

- Access to the User Settings (see the Figure 11).
- Use the Set Control [11] to highlight the parameter or function icon which will be added to the Welding Parameters Bar [27], for example Run-in WFS.

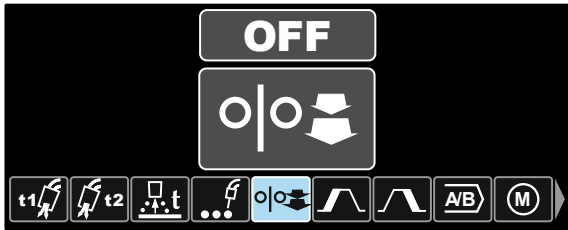

Figure 12.

- Press the Set Button [11]. Run-in WFS icon will drop.

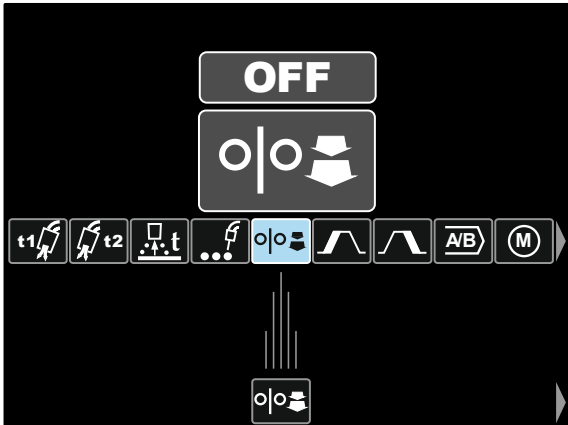

Figure 13.

Note: To remove the icon press the Set Control [11] once again.

Note: To cancel the change and exit the User Settings Menu – press the Left Button [7].

- Confirm the select – press the Right Button [12]. The User Settings Menu is closed. The Selected parameters or function is added to the Welding Parameters Bar [27].



Figure 14.

To remove the selected parameter or function from the Welding Parameters Bar [27]:

- Access to the User Settings.
- Use the Set Control [11] to highlight the selected parameter or function icon which will be added to the Welding Parameters Bar [27].

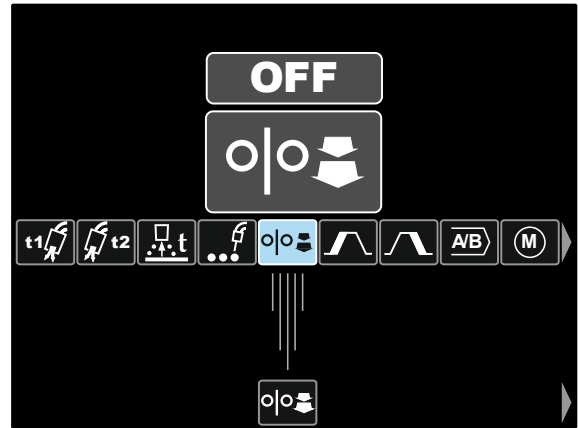

Figure 15.

- Press the Set Control [11] – The selected icon will disappear from the display bottom.

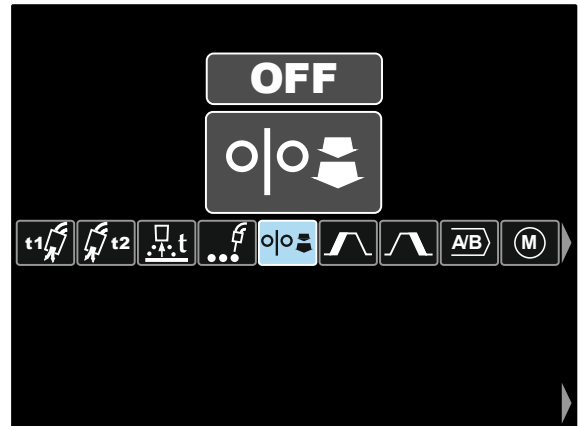

Figure 16.

- Confirm the select – press the Right Button [12]. The User Settings Menu is closed. The Selected parameters or function was disappeared from the Welding Parameters Bar [27]

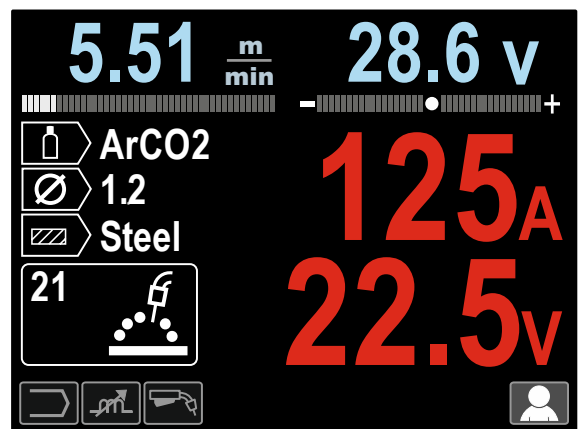
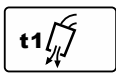

Figure 17.



Preflow Time adjusts the time that shielding gas flows after the trigger is pulled and prior to feeding.

- Factory default, Preflow Time is set at 0.2 seconds.
- Adjust range: from 0 seconds (OFF) to 25 seconds.

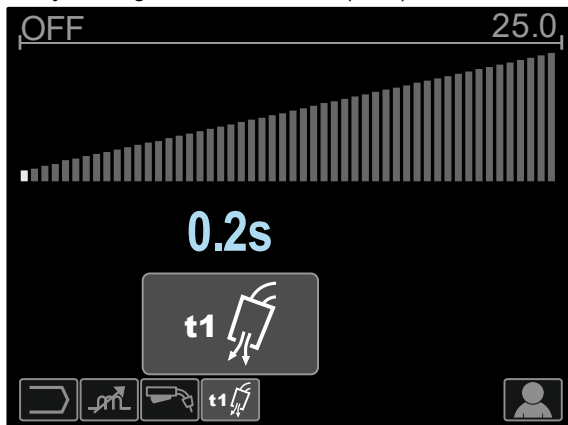
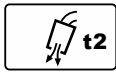

Figure 18.



Postflow Time adjusts the time that shielding gas flows after the welding output turns off.

- Factory default, Postflow Time is set at 2.5 second.
- Adjust range: from 0 seconds (OFF) to 25 seconds.

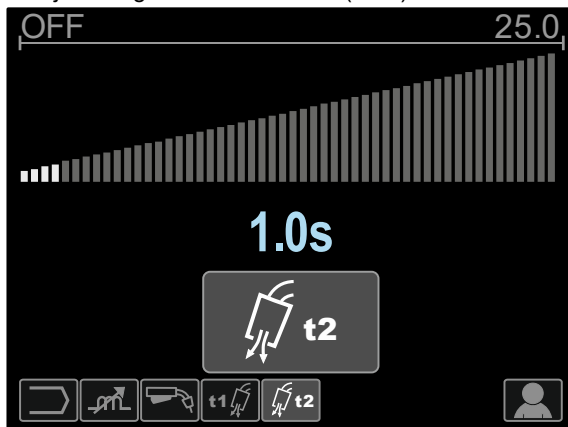
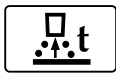

Figure 19.



Burnback Time is the amount of time that the weld output continues after the wire stops feeding. It prevents the wire from sticking in the puddle and prepares the end of the wire for the next arc start.

- Factory default, Burnback Time is set at 0.07 seconds.
- Adjust range: from OFF to 0.25 seconds.

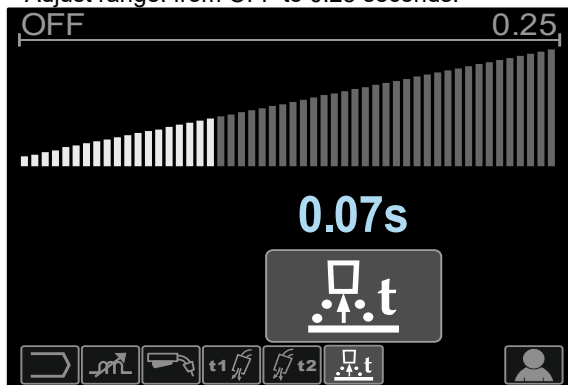
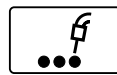

Figure 20.



Spot Timer – adjusts the time welding will continue even if the trigger is still pulled. This option has no effect in 4-Step Trigger Mode.

- Factory default, Spot Timer is OFF.
- Adjust range: from 0 second (OFF) to 120 seconds.

Note: Spot Timer has no effect in 4-Step Trigger Mode

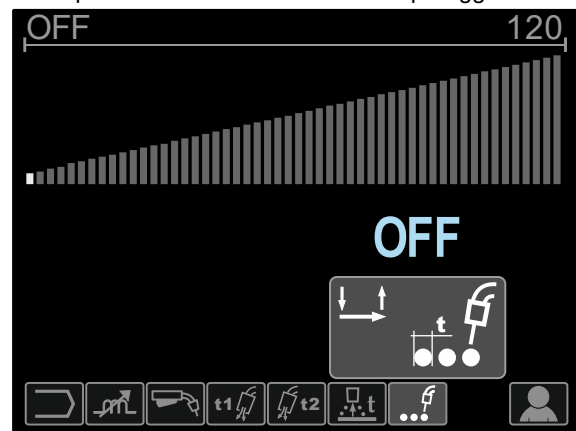

Figure 21.



Run-in WFS – sets the wire feed speed from the time the trigger is pulled until an arc is established.

- Factory default, Run-in is turned off.
- Adjust range: from minimum to maximum WFS.

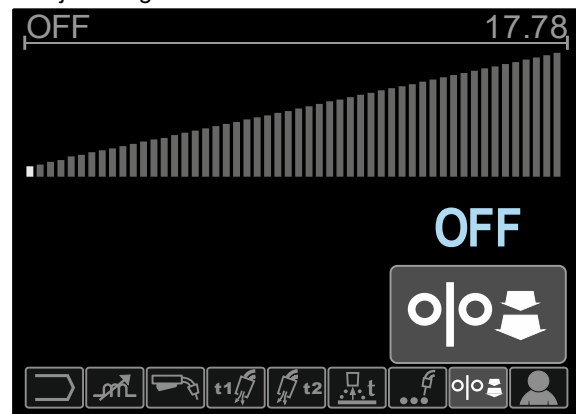

Figure 22.



The Start Procedure controls the WFS and Volts (or Trim) for a specified time at the beginning of the weld. During the start time, the machine will ramp up or down from the Start Procedure to the preset Welding Procedure.

- Adjust time range: from 0 seconds(OFF) to 10 seconds.

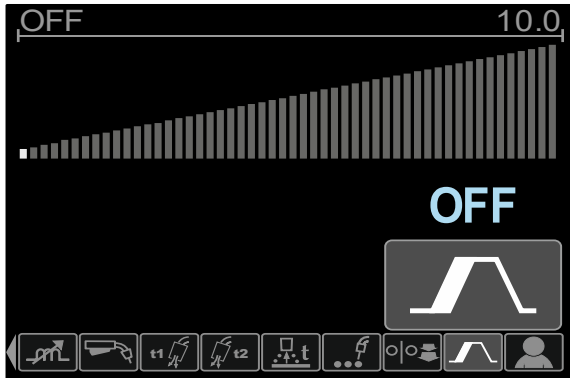

Figure 23.

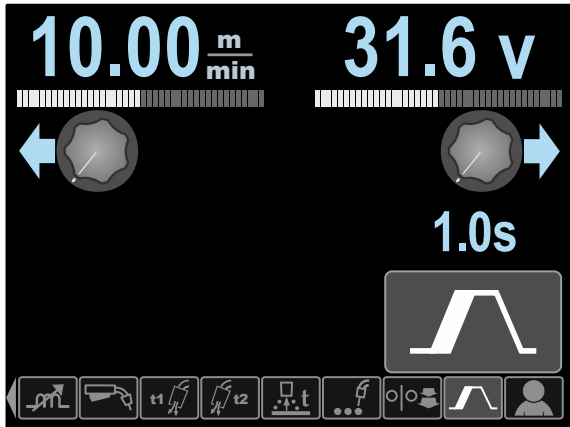

Figure 24.



Crater Procedure controls the WFS (or value in ampere units) and Volts (or Trim) for a specified time at the end of the weld after the trigger is released. During the Crater time, the machine will ramp up or down from the Weld Procedure to the Crater Procedure.

- Adjust time range: from 0 seconds (OFF) to 10 seconds.

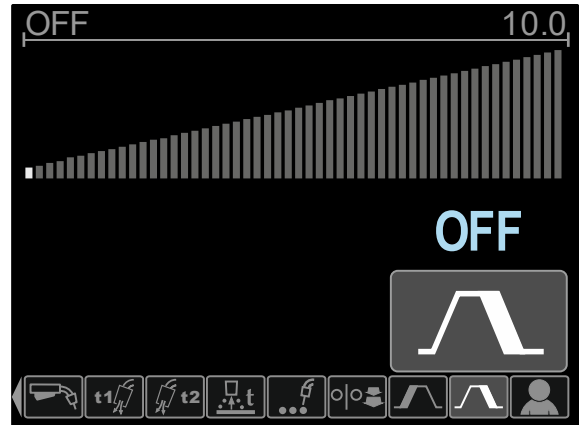

Figure 25.

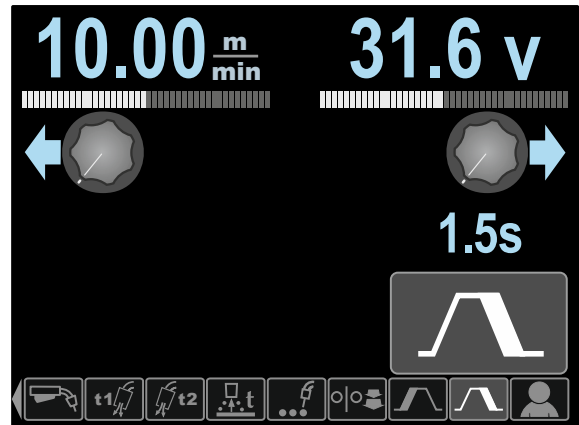

Figure 26.



A/B procedure (PF46 only) enables quick weld procedure change.

The sequence changes may occur between:

- Two different welding programs.
- Different settings for the same program.



User Memory (PF46 only) enables:

- Store the welding programs to one of the nine user memory.
- Recall the stored programs from the user memory

To store the Welding Program to the User Memory:

- Add the User Memory icon to the Welding Parameters Bar [27].
- Use the Set Control [11] to highlight the User Memory icon.

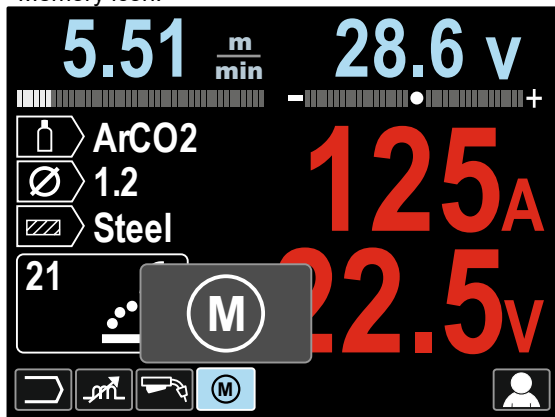

Figure 27.

- Press the Set Control [11] – the User Memory Menu is shown on the display.
- Use the Set Control [11] to highlight the Save to the Memory icon.

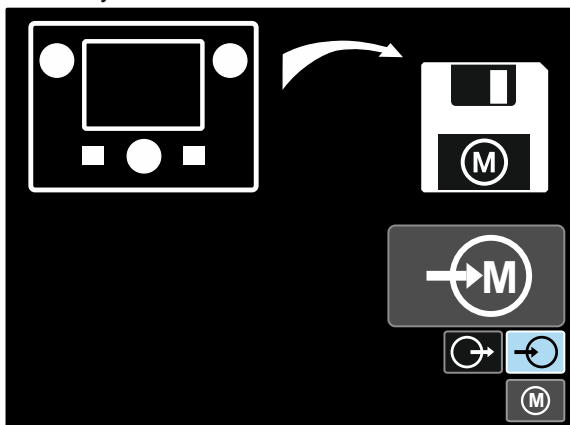

Figure 28.

- Press the Set Control [11].
- Use the Set Control [11] to highlight the Memory Number where the program would be stored.
- Confirm the select – press the Right Button [12].

To recall the Welding Program from The User Memory:

Note: Before using, the Welding Program had to be assigned to the user memory

- Add the User Memory icon to the Welding Parameters Bar [27].
- Use the Set Control [11] to highlight the User Memory icon.
- Press the Set Control [11] – the User Memory Menu is shown on the display.
- Use the Set Control [11] to highlight the Recall to the Memory icon.

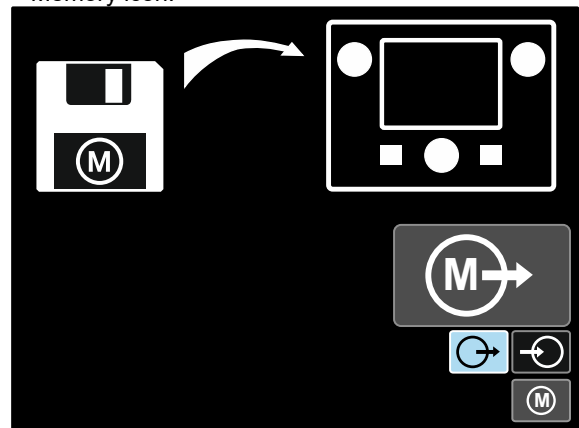

Figure 29.

- Press the Set Control [11].
- Use the Set Control [11] to highlight the Memory Number which from the Welding Program will be recall.
- Confirm the select – press the Right Button [12].
- Press and hold for 1 second the Set Control [11].

Note: If the parameters saved in the program memory are highlighted on red (figure 30) it means that the unit of the workpoint and/or trim in Setup Menu is not the same as the unit of these parameters saved in the program memory. In that case, after the welding program is recalled, the parameters marked on red will be changed. To restore the units compliances, enter to Setup Menu and set the parameters P.28 and/or P.20 accordingly.

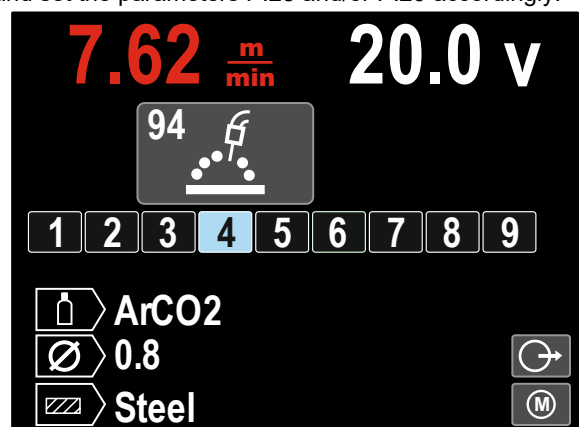
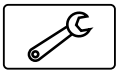

Figure 30



Additionally, the **Setting and Configuration Menu** can be also entered from the User Settings Menu. Full description **the Setting and Configuration Menu** in Section 3.10.

Note: The Setting and Configuration Menu icon cannot add to the Welding Parameters Bar [27].

To go to the Setting and Configuration Menu from the User Settings Menu:

- Access to the User Settings Menu.
- Use the Set Control [11] to highlight the Settings and Configuration Menu icon.

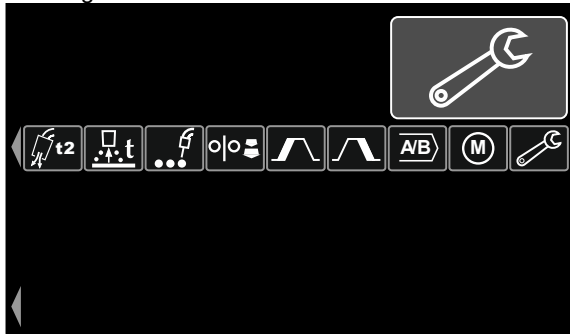

Figure 31.



Figure 32.

- The Settings and Configuration Menu is shown on the display.

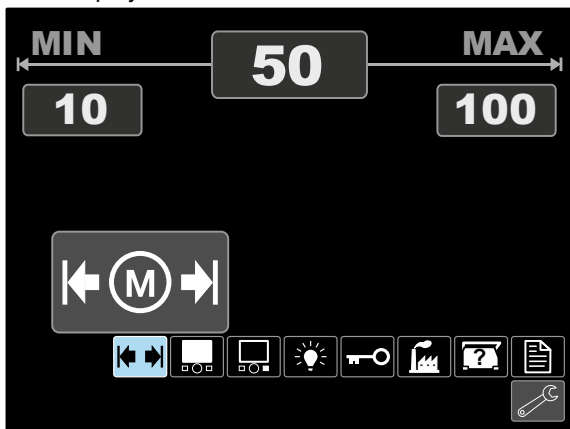

Figure 33.

The Settings and Configuration Menu

Two ways to access to the Settings and Configuration Menu:

- From The User Settings Menu (see dedicated section)
- Press the Left [7] and the Right [12] Buttons simultaneously

Depending on the Wire Feeder, The Settings and Configuration Menu enables:

Icon	Description	PF44	PF46
	Set the Memory Limits	-	✓
	Set the Display Configuration	✓	✓
	Assignment Function to the Right Button	✓	✓
	Set the Brightness Level	✓	✓
	Lock / Unlock	✓	✓
	Restore Factory Setting	✓	✓
	View Software and Hardware Version Information.	✓	✓
	Access to the Configuration Menu	✓	✓

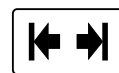

Memory Limits (PF46 only)

Note: The Limits can be set only for the programs stored in the user memory.

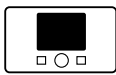

The limits can be set for:

- Welding Current
- Wire Feed Speed, WFS
- Welding Voltage
- Wave Controls



Display Configuration

Four Display Configuration are available:

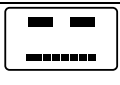
	True Energy™ Menu
	Weld Score™ Menu
	Big Meters Menu (factory default)
	Standard Menu

To set the Display Configuration:

- Access to the Settings and Configuration Menu.
- Use the Set Control [11] to highlight the Display Configuration icon.

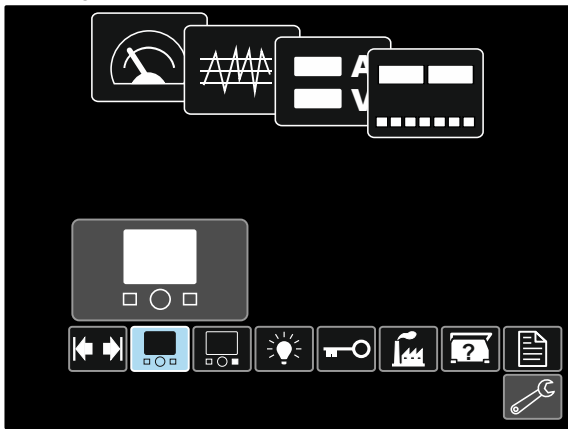

Figure 34.

- Press the Set Control [11]. The Display Configuration Menu is shown on the display.

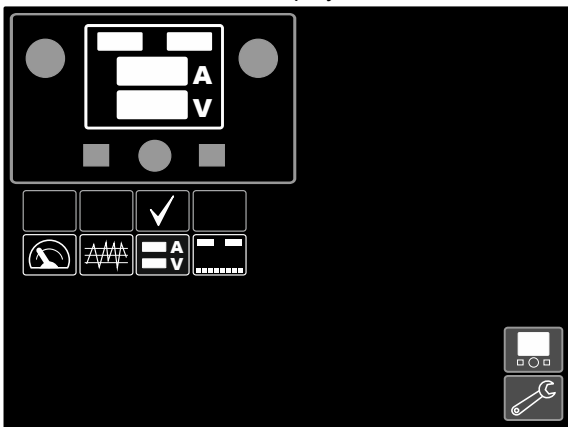

Figure 35.

- Use the Set Control [11] to highlight the display configuration icon, for example Weld Score.

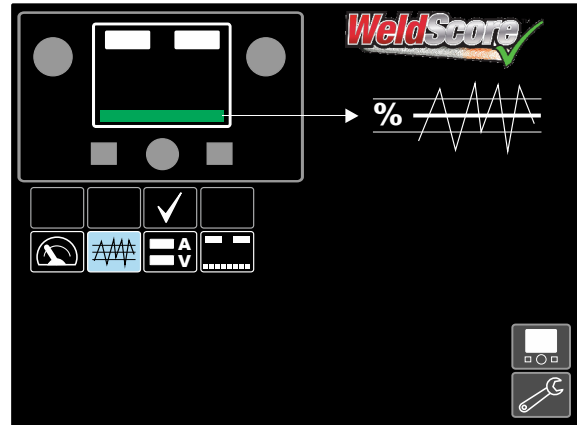

Figure 36.

- Press the Set Control [11] to select the Display Configuration. The Check Mark will also change the position.

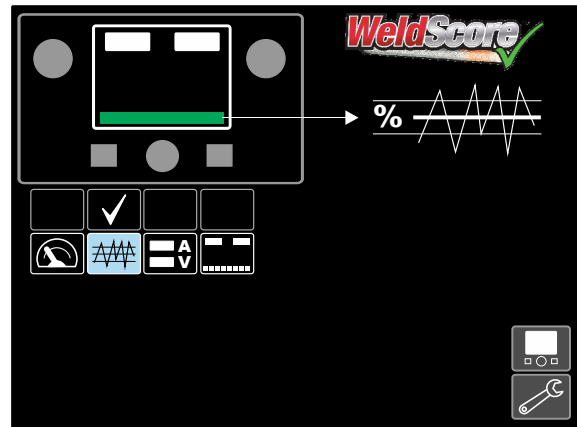

Figure 37.

- Confirm the select – press the Right Button [12].
- Return to the main level of the interface. Instead of the Welding Parameters Bar is visible the Weld Score Bar.

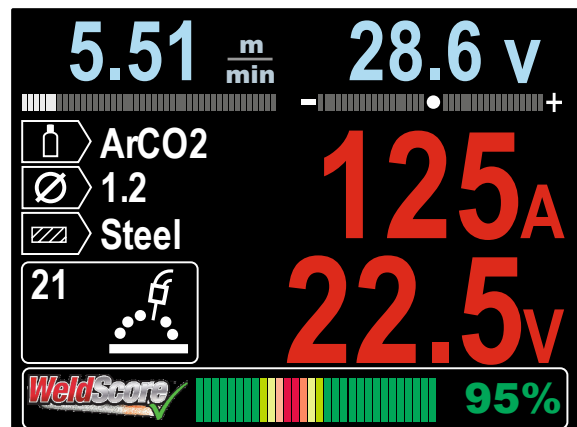
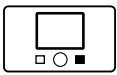

Figure 38.

Note: If the Set Control [11] is pressed, the Welding Parameters Bar will be visible for 5 seconds.



Assignment Function to the Right Button

To the Right Button [12] can assign:

Icon	Description	PF44	PF46
	Disabled - OFF (factory default)	✓	✓
	Crater Procedure	✓	✓
	Rub-in WFS	✓	✓
	Wave Controls	✓	✓
	Recall the Program stored in the User Memory	-	✓

Note: To use the assigned functions:

- Recall the Program stored in the User Memory
- Crater Procedure
- Run-in WFS

icons of these functions must be added to the Welding Parameters Bar [27].

To assign the function to the Right Button [12]:

- Access to the Settings and Configuration Menu.
- Use the Set Control [11] to highlight the Assigned Function to the Right Button icon.

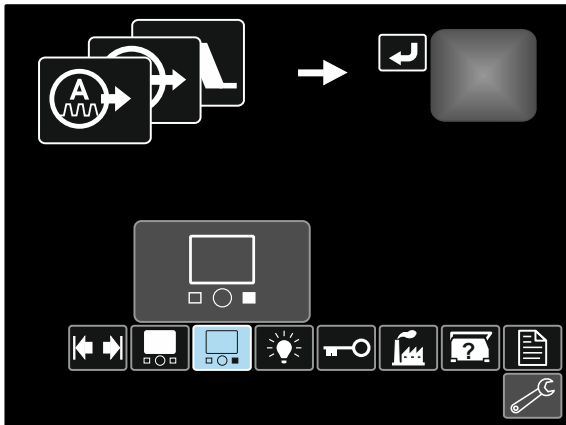

Figure 39.

- Press the Set Control [11]. The Assigned Function Menu is shown on the display.

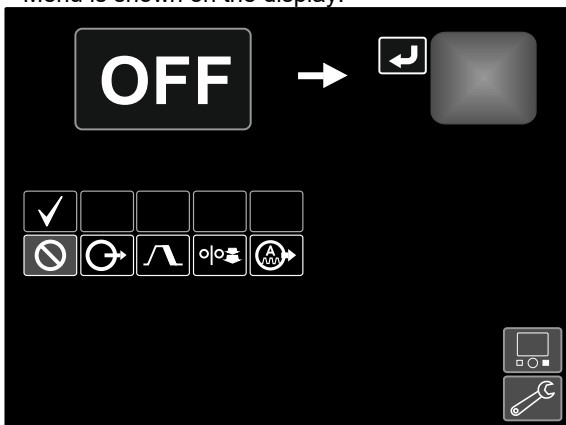

Figure 40.

- Use the Set Control [11] to highlight the function which will be assigned to the Right Button [12], for example Crater Procedure.

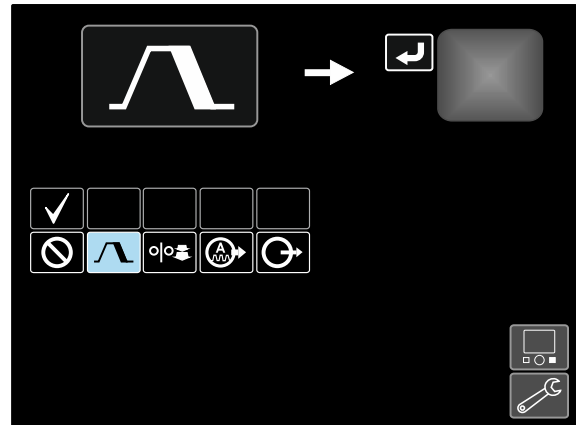

Figure 41.

- Press the Set Control [11] to select the Assigned Function to the Right Button [12]. The Check Mark will also change the position.

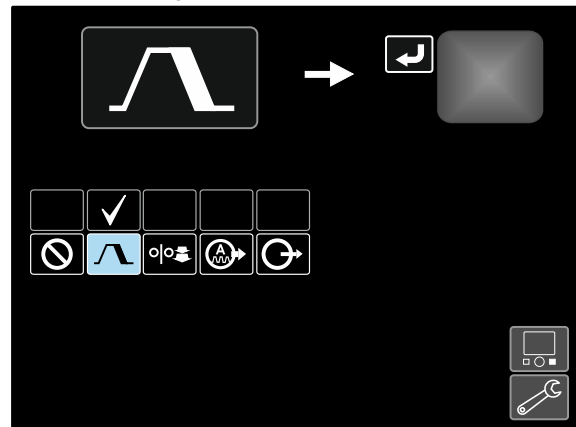

Figure 42.

- Confirm the select – press the Right Button [12].
- Return to the main level of the interface. If the Right Button [12] is pressed, the Crater Interface Settings will be shown on the display.



The Brightness Level

Enables the Brightness Level.

- Adjust range: from 0 to +10.



Lock / Unlock

Can lock / unlock:

Icon	Description	PF44	PF46
	All Interface Components	✓	✓
	The Left [9] and / or Right [10] Control	✓	✓
	The Welding Parameters Bar [27] The Set Control [11] and the Left [7] and the Right [12] button	✓	✓
	Configuration Menu	✓	✓
	User Memory	-	✓

To set the lock:

- Access to the Settings and Configuration Menu.
- Use the Set Control [11] to highlight the Lock/Unlock icon.

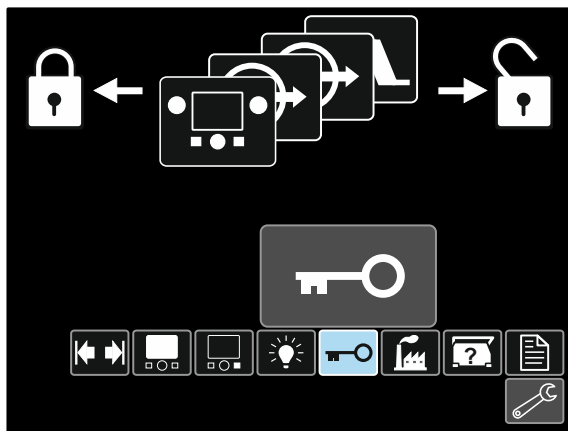

Figure 43.

- Press the Set Control [11]. The Lock Menu is shown on the display.

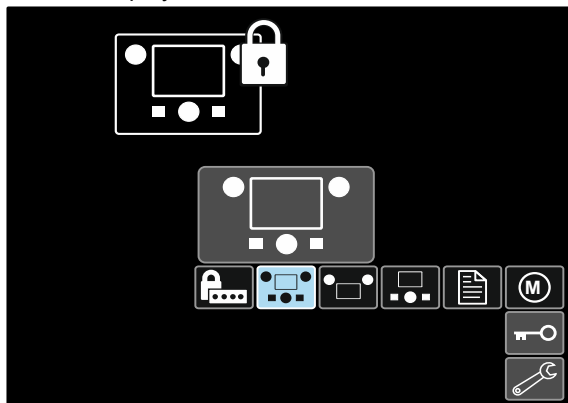

Figure 44.

- Use the Set Control [11] to highlight the element which will be locked, for example All Interface Components – see the Figure 44.
- Press the Set Control [11].
- Use the Set Control [11] to highlight the Lock icon.
- Press the Set Control [11] to select the Lock. The Check Mark will also change the position.

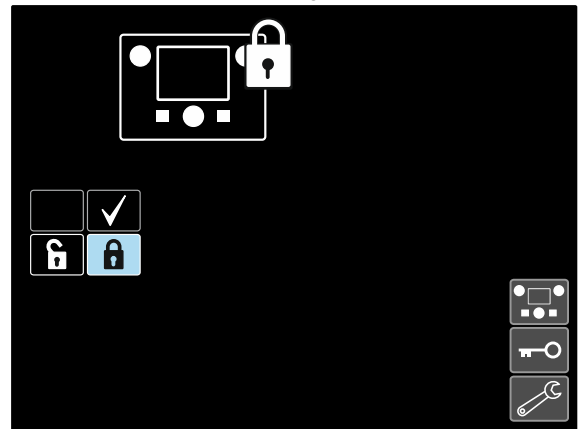

Figure 45.

- Confirm the select – press the Right Button [12].

To unlock functions, press and hold the Left Button [7] for four seconds and choose locked elements.

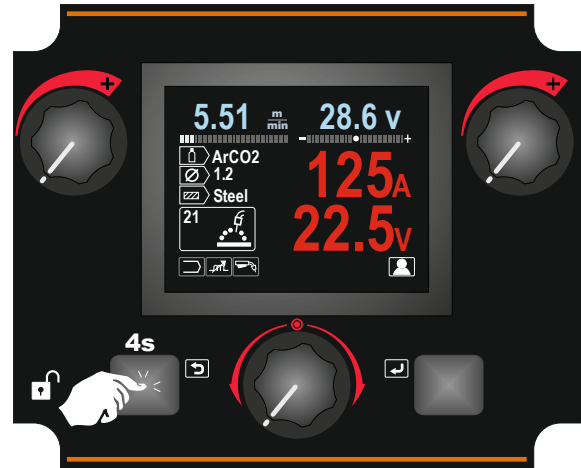
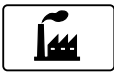

Figure 46.

To prevent accidental changes, the User Passcode may set up. The User Passcode locks access to the Lock Menu. In that case to change the Lock Settings the User Passcode needs to be set. The default passcode is 0000. It enables free access to Lock Menu.



Restore Factory Settings

Note: After Factory Settings restore, the settings stored in user memory are deleted.

To restore Factory Settings:

- Access to the Settings and Configuration Menu.
- Use the Set Control [11] to highlight the Restore Factory Settings icon.

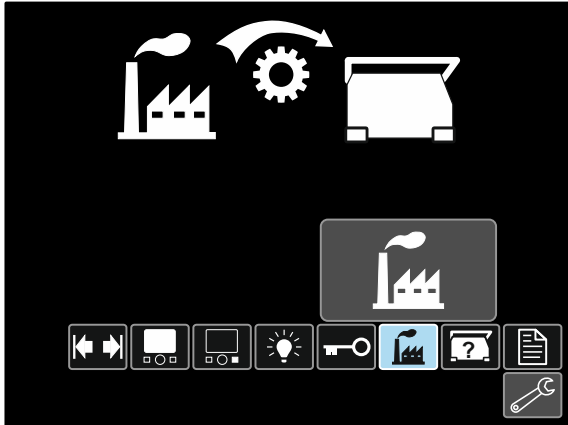

Figure 47.

- Press the Set Control [11]. The Restore Factory Settings Menu is shown on the display.
- Use the Set Control [11] to highlight the Check Mark.

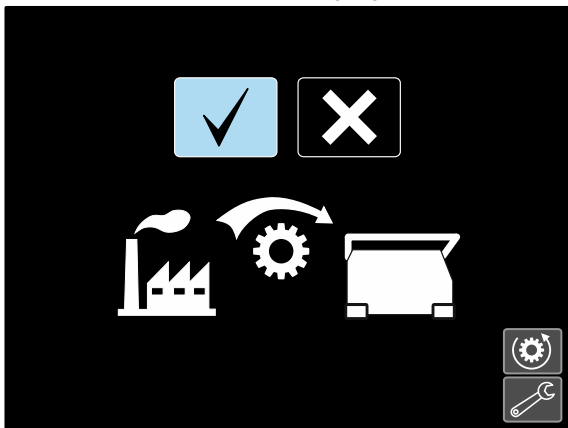

Figure 48.

- Confirm the select – press the Right Button [12]. The factory settings are restored.



Diagnostic Information

Available information:

- Software Version
- Hardware Version
- Welding Software
- Ethernet IP Address
- Power Source Protocol
- Event Logs
- Fatal Logs.



Setup (Configuration Menu)

Enables access to the Configuration Parameters of the Device.

To set the Configuration Parameters of the Device:

- Access to the Settings and Configuration Menu.
- Use the Set Control [11] to highlight the Restore Factory Settings icon.

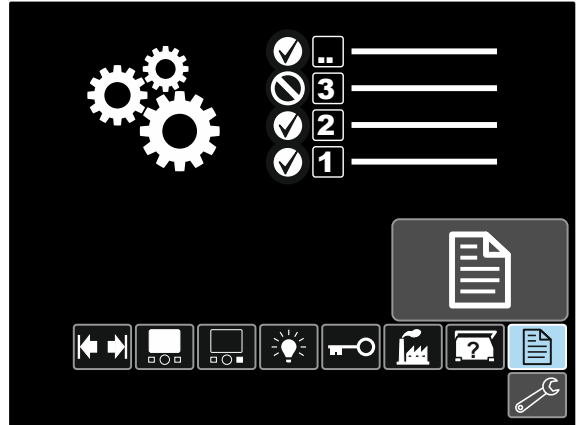

Figure 49.

- Press the Set Control [11]. The Configuration Menu is shown on the display.
- Use the Set Control [11] to highlight the Parameter Number which will be changed, for example P.1 - allows change WFS units, factory default: "Metric" = m/min.

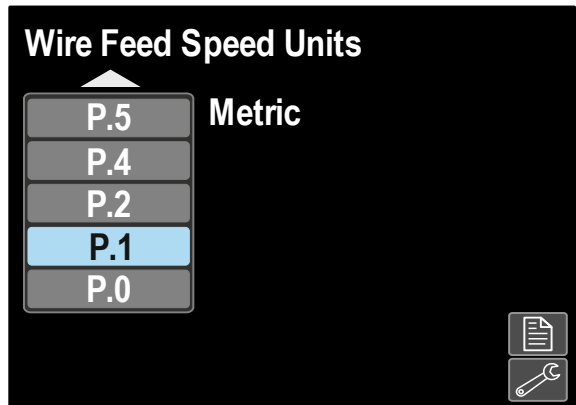

Figure 50.

- Press The Set Control [11].
- Use the Set Control [11] to highlight the "English" = in/min.

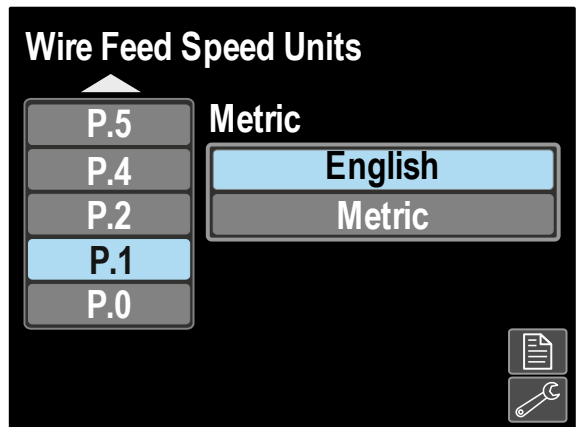

Figure 51.

- Confirm the select – press the Right Button [12].

Table 11. The Configuration Parameters

P.0	The Menu Exit	Enables exit from menu
P.1	Wire Feed Speed (WFS) units	Enables change WFS units: <ul style="list-style-type: none"> • "Metric" (factory default) = m/min; • "English" = in/min.
P.4	Recall Memory with Trigger (PF46 only)	This option allows a memory to be recalled by quickly pulling and releasing the gun trigger: <ul style="list-style-type: none"> • "Enable" = Selecting memories 2 through 9 by quickly pulling and releasing the gun trigger. To recall a memory with the gun trigger, quickly pull and release the trigger the number of times that correspond to the memory number. For example, to recall memory 3, quickly pull and release the trigger 3 times. Trigger memory recall can only be performed when the system is not welding. • "Disable" (factory default) = Memory selection is performed only by the Panel Buttons.
P.5	Procedure Change Method (PF46 only)	This option selects how remote procedure selection (A/B) will be made. The following methods can be used to remotely change the selected procedure: <ul style="list-style-type: none"> • "External Switch" (factory default) = Dual Procedure selection may only be performed by the Cross-switch gun or remote control. • "Quick Trigger" = Allows switching between Procedure A and procedure B while welding with 2-stroke mode. The Cross-switch gun or remote control is required. To operate: <ul style="list-style-type: none"> ♦ Select " WFS/Proced. A-B" in P.25 to set up parameters for A and B procedures. ♦ Start the weld by pulling the gun trigger. The system will weld with procedure A settings. ♦ While welding, quickly release and then pull the gun trigger. The system will switch to procedure B settings. Repeat to switch back to procedure A settings. The procedure can be changed as many times as needed during the weld. ♦ Release the trigger to stop welding. When the next weld is made, the system will start again with procedure A. • "IntegralTrigProc" = Allows switching between Procedure A and procedure B while welding with 4-stroke mode. When in 2-step, the system operates identical to the External Switch selection. To operate in 4-step: <ul style="list-style-type: none"> ♦ Select " WFS/Proced. A-B" in P.25 to set up parameters for A and B procedures. ♦ Start the weld by pulling the gun trigger. The system will weld with procedure A settings. ♦ While welding, quickly release and then pull the gun trigger. The system will switch to procedure B settings. Repeat to switch back to procedure A settings. The procedure can be changed as many times as needed during the weld. ♦ Release the trigger to stop welding. When the next weld is made, the system will start again with procedure A.
P.7	Gun Offset Adjustment	This option adjusts the wire feed speed calibration of the pull motor of a push-pull gun. This should only be performed when other possible corrections do not solve any push-pull feeding problems. An rpm meter is required to perform the pull gun motor offset calibration. To perform the calibration procedure do the following: <ol style="list-style-type: none"> 1. Release the pressure arm on both the pull and push wire drives. 2. Set the wire feed speed to 200 ipm. 3. Remove wire from the pull wire drive. 4. Hold an rpm meter to the drive roll in the pull gun. 5. Pull the trigger on the push-pull gun. 6. Measure the rpm of the pull motor. The rpm should be between 115 and 125 rpm. If necessary, decrease the calibration setting to slow the pull motor, or increase the calibration setting to speed up the motor. <ul style="list-style-type: none"> • The calibration range is -30 to +30, with 0 as the default value.

P.8	TIG Gas Control	<p>This option allows control over which gas solenoid actuates while TIG welding.</p> <ul style="list-style-type: none"> • "Valve (manual)" = No MIG solenoid will actuate while TIG welding, gas flow is manually controlled by an external valve. • "Feeder Solenoid" = The internal (feeder) MIG solenoid will turn on and off automatically while TIG welding. • "Pwr Src Solenoid" = Any gas solenoid connected to the power source will turn on and off automatically while TIG welding. This selection will not appear in the list if the power source does not support a gas solenoid. <p>Notes: Preflow is not available while TIG welding. Postflow is available - the same Postflow time will be used in MIG and TIG. When machine output on/off is controlled via the upper right Control [10], gas flow will not start until the tungsten touches the work. Gas flow will continue when the arc is broken until the Postflow time expires. When machine output on/off is controlled via an arc start switch or foot Amptrol, gas will begin flowing when the output is turned on and will continue flowing until the output is turned off and the Postflow time expires.</p>
P.9	Crater Delay	<p>This option is used to skip the Crater sequence when making short tack welds. If the trigger is released before the timer expires, Crater will be bypassed and the weld will end. If the trigger is released after the timer expires, the Crater sequence will function normally (if enabled).</p> <ul style="list-style-type: none"> • OFF (0) to 10.0 seconds (default = Off)
P.14	Reset Consumable Weight	<p>Use this option to reset the initial weight of the consumable package.</p> <ul style="list-style-type: none"> • "No" = Weight reset annulment. • "Yes" = Weight reset accept. <p>In addition it shows the current wire weight.</p> <p>Note: This option will only appear with systems using Production Monitoring.</p>
P.16	Push-Pull Gun Control Behavior	<p>This option determines how the potentiometer on the Push/Pull torch will behave.</p> <ul style="list-style-type: none"> • "Gun Pot Enabled" (default) = The welding wire feed speed is always controlled by the potentiometer on the push-pull gun. The Left Control [9] is only used to adjust Start and Crater wire feed speed. • "Gun Pot Disabled" = The wire feed speed is always controlled by the Left Control [9]. This setting is useful when the operator wishes to have wire feed speed settings recalled from memories and not have the potentiometer "overwrite" the setting. • "Gun Pot Proc A" = When in procedure A, the welding wire feed speed is controlled by the potentiometer on the push-pull gun. When in procedure B, the welding wire feed speed is controlled by the Left Control [9]. This setting allows a fixed wire feed speed to be selected in procedure B and not have the potentiometer "overwrite" the setting when the procedure changes.

P.17	Remote Control Type	<p>This option selects the type of analog remote control being used. Digital remote control devices (those with a digital display) are configured automatically.</p> <ul style="list-style-type: none"> • "Push-Pull Gun" = Use this setting while MIG welding with a push-pull gun that uses a potentiometer for wire feed speed control (this setting is backward compatible with "P.17 Gun Selection" = PushPull). • "TIG Amp Control" = Use this setting while TIG welding with a foot or hand current control device (Amptrol). While TIG welding, the upper left Control on the User Interface sets the maximum current obtained when the TIG amp control is at its maximum setting. • "Stick/Gouge Rem." = Use this setting while stick welding or gouging with a remote output control device. While stick welding, the upper left Control on the User Interface sets the maximum current obtained when the stick remote is at its maximum setting. While gouging, the upper left Control is disabled and the gouging current is set on the remote control. • "All Mode Remote" = This setting allows the remote control to function in all weld modes which is how most machines with 6-pin and 7-pin remote control connections operate. • "Joystick MIG Gun" (European default) = Use this setting while MIG welding with a push MIG gun with a joystick control. Stick, TIG and gouge welding currents are set at the User Interface. <p>Note: On machines that do not have a 12-pin connector, the "Joystick MIG Gun" settings will not appear.</p>
P.20	Display Trim as Volts Option	<p>Determines how trim is displayed</p> <ul style="list-style-type: none"> • "No" (factory default) = The trim is displayed in the format defined in the weld set. • "Yes" = All trim values are displayed as a voltage. <p>Note: This option may not be available on all machines. The power source must support this functionality, or this option will not appear in the menu.</p>
P.22	Arc Start/Loss Error Time	<p>This option can be used to optionally shut off output if an arc is not established, or is lost for a specified amount of time. Error 269 will be displayed if the machine times out. If the value is set to OFF, machine output will not be turned off if an arc is not established nor will output be turned off if an arc is lost. The trigger can be used to hot feed the wire (default). If a value is set, the machine output will shut off if an arc is not established within the specified amount of time after the trigger is pulled or if the trigger remains pulled after an arc is lost. To prevent nuisance errors, set Arc Start/Loss Error Time to an appropriate value after considering all welding parameters (run-in wire feed speed, weld wire feed speed, electrical stick out, etc). To prevent subsequent changes to Arc Start/Loss Error Time, the setup menu should be locked out by setting Preference Lock = Yes using the Power Wave Manager software.</p> <p>Note: This parameter is disabled while welding in Stick, TIG or Gouge.</p>
P.25	Joystick Configuration	<p>This option can be used to change the behavior of the left and right joystick positions:</p> <ul style="list-style-type: none"> • "Disable Joystick" = The joystick does not function. • "WFS/Trim" = The left and right joystick positions will adjust Arc Length Trim, Arc Voltage, Power or STT® Background Current based on the selected weld mode. For example, when a non-synergic STT® weld mode is selected, the left and right joystick positions will adjust Background Current. When a Power mode is selected, the left and right joystick positions will adjust the Power (kW). • "WFS/Job"(memory) = The left and right joystick positions will: <ul style="list-style-type: none"> • Select a user memory while not welding. • Adjust Trim/Voltage/Power/STT Background Current while welding. • "WFS/Proced. A-B" = The left and right joystick positions will be used to select procedure A and B, while welding and while not welding. The left joystick position selects procedure A, the right joystick position selects procedure B. <p>Note: In all configurations other than "Disable Joystick", the up and down joystick positions will adjust the wire feed speed, while welding and while not welding.</p>

P.28	Display Workpoint as Amps Option	<p>Determines how workpoint is displayed:</p> <ul style="list-style-type: none"> • "No" (factory default) = The workpoint is displayed in the format defined in the weld set. • "Yes" = All workpoint values are displayed as an amperage. <p>Note: This option may not be available on all machines. The power source must support this functionality, or this option will not appear in the menu</p>
P.80	Sense From Studs	<p>Use this option for diagnostic purposes only. When power is cycled, this option is automatically reset to False.</p> <ul style="list-style-type: none"> • "False" (default) = Voltage sensing is automatically determined by the selected weld mode and other machine settings. • "True" = Voltage sensing is forced to "studs" of the power source.
P.81	Electrode Polarity	<p>Used in place of DIP switches for configuration of the work and electrode sense leads</p> <ul style="list-style-type: none"> • "Positive" (default) = Most GMAW welding procedures use Electrode Positive welding. • "Negative" = Most GTAW and some inner shield procedures use Electrode Negative welding.
P.82	Voltage Sense Display	<p>Allows viewing of Voltage Sense Lead Selection to aid in troubleshooting. The configuration is displayed as a text string on the display whenever the output is enabled. This parameter is not saved on a power cycle, but will be reset to False.</p>
P.84	Pwr Src Select	<p>Power Source Select – this option is only for the LADI interface. It selects the analog power source that is connected</p>
P.95	User interface type	<p>Determines how the user interface works:</p> <ul style="list-style-type: none"> • "Feeder" (factory default) – UI works as Feeder. • "STICK/TIG" – Dedicated to work UI with a welding power source (without Wire feeder). UI allows to set the programs for welding SMAW and GTAW process. <p>Note: "STICK / TIG" allows to work with an analog wire feeder also. In this case, additional programs are available for welding GMAW process in non-synergic mode.</p> <ul style="list-style-type: none"> • "Parallel" – UI works as a remote control. Parallel may be used only in parallel with the main panel, which can be set to the "FEEDER" or "STICK / TIG". <p>Note: Selecting the UI type makes restart of system. Note: Back to the factory setting forces Feeder type.</p>
P.99	Show Test Modes?	<p>Uses for calibration and tests.</p> <ul style="list-style-type: none"> • "No" (factory default) = Turned off; • "Yes" = Allows to selection test modes. <p>Note: After the device has been restarted the P.99 is "NO".</p>

Table 12. List of Secured Parameters accessible through Power Wave Manager only

<p>P.003</p>	<p>Display Options</p>	<p>Enables select between one of the four Display Configurations:</p> <ul style="list-style-type: none"> • "True Energy" = Energy is displayed, along with time in HH:MM:SS format. • "Weld Score" = The accumulative weld score result is shown. • "Big Meters" (factory default) = After 5 seconds of inactivity, only Welding Current and Voltage is shown on the display, the Welding Parameters Bar [27] is invisible. To activate the Welding Parameters Bar [27], press the Set Control [11]. • "Standard" = On the Display is shown preset information during and after a weld.
<p>P.501</p>	<p>Encoder Lockout</p>	<p>Locks one or both of the upper Controls ([9] and [10]), preventing the operator from changing wire feed speed, amps, volts or trim. The function of each upper Control depends on the selected weld mode.</p> <ul style="list-style-type: none"> • "Both Encoders Unlocked" (factory default) = The Left [9] and the Right Control is unlocked. • "Both Encoders Locked" = The Left [9] and the Right Control is locked. • "Right Encoder Locked" = The Right Control [10] is locked. • "Left Encoder Locked" = The Left Control [9] is locked. <p>Note: This parameter can only be accessed using PowerWave Manager software.</p>
<p>P.502</p>	<p>Memory Change Lockout (PF46 only)</p>	<p>Determines if the memories can be overwritten with new contents.</p> <ul style="list-style-type: none"> • "No" (factory default)= Memories can be saved and limits can be configured. • "Yes" = Memories cannot be changed - saving is prohibited and limits cannot be re-configured. <p>Note: This parameter can only be accessed using PowerWave Manager software.</p>
<p>P.503</p>	<p>Memory Button Disable (PF46 only)</p>	<p>Disables the specified memory button(s). When a memory is disabled, welding procedures cannot be restored from or saved to that memory. If an attempt is made to save or restore a disabled memory, a message will be displayed on the lower display indicating the memory number is disabled. In multi-head systems, this parameter disables the same memory buttons on both feed heads.</p> <p>Note: This parameter can only be accessed using PowerWave Manager software.</p>
<p>P.504</p>	<p>Mode Select Panel Lock</p>	<p>Selects between several Mode Select Panel lockout preferences. When a Mode Select Panel selection is locked and an attempt is made to change that parameter, a message will be displayed on the display indicating the parameter is locked.</p> <ul style="list-style-type: none"> • "All MSP Options Unlocked" (factory default) = All adjustable parameters on the Mode Select Panel are unlocked. • "All MSP Options Locked" = All Controls and buttons on the Mode Select Panel are locked. • "Start & End Options Locked" = The Start and End parameters on the Mode Select Panel are locked, all others are unlocked. • "Weld Mode Option Locked" = The weld mode cannot be changed from the Mode Select Panel, all others Mode Select Panel settings are unlocked. • "Wave Control Options Locked" = The Wave Control parameters on the Mode Select Panel are locked, all others are unlocked. • "Start, End, Wave Options Locked" = The Start, End and Wave Control parameters on the Mode Select Panel are locked, all others are unlocked. • "Start, End, Mode Options Locked" = The Start, End and Weld Mode Select parameters on the Mode Select Panel are locked, all others are unlocked. <p>Note: This parameter can only be accessed using PowerWave Manager software.</p>

P.505	Setup Menu Lock	<p>Determines if the setup parameters can be modified by the operator without entering a passcode.</p> <ul style="list-style-type: none"> • "No" (factory default)= The operator can change any set menu parameter without first entering the passcode even if the passcode is non-zero (0000). • "Yes" = The operator must enter the passcode (if the passcode is non-zero) in order to change any setup menu parameters. <p>Note: This parameter can only be accessed using PowerWave Manager software.</p>
P.506	Set User Interface Passcode	<p>Prevents unauthorized changes to the equipment. The default passcode is 0000 which allows full access. A nonzero passcode will prevent unauthorized:</p> <p>Changes to memory limits, saving to memory (if P.502 = Yes). Changes to setup parameters (if P.505 = Yes).</p> <p>Note: This parameter can only be accessed using PowerWave Manager software.</p>
P.507	Clear All Memories	<p>Allows the operator to quickly set all memories to the default weld mode and welding parameters.</p> <ul style="list-style-type: none"> • "No" (factory default) • "Yes" = Set all memories to the default weld mode and welding parameters. <p>Note: This parameter can only be accessed using PowerWave Manager software.</p>
P.509	UI Master Lockout	<p>Locks all user interface controls, preventing the operator from making any changes.</p> <p>Note: This parameter can only be accessed using PowerWave Manager software.</p>

USB Memory (PF46 only)

When USB Memory Stick is connected to the USB Receptacle [21], USB Menu appears on the display.

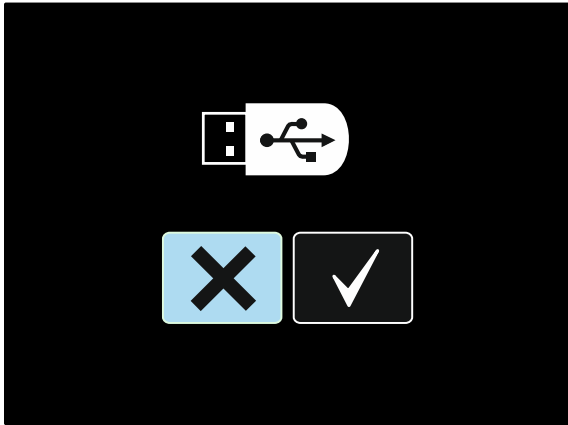

Figure 52.

The following data can be save on a USB Memory Stick or loaded from the USB Memory Stick:

Icon	Description
	Settings
	Configuration Menu (Setup)
	All welding programs stored in user memory
	One of the welding programs

To save the data on a USB Memory Stick:

- Connect a USB Memory Stick to the USB Receptacle [21].
- Use the Set Control [11] to highlight the Check Mark icon.

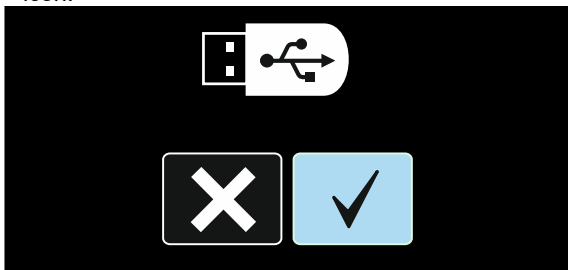

Figure 53.

- Press the Right Button [12] to confirm the USB Memory Stick selection.
- Use the Set Control [11] to highlight the Save icon.

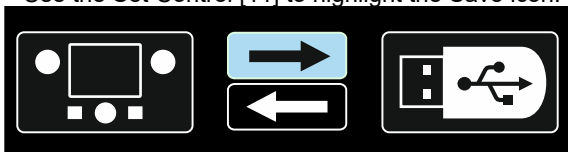

Figure 54.

- Press the Right Button [12] to confirm the save on a USB Memory Stick.
- Create or chose a file in which will be saved copies of the data. "+++" mark means a new file.



Figure 55.

- The display shows the Save Data Menu on a USB Memory Stick. In this case, a copy data will be saved in the file LEB1.WMB.

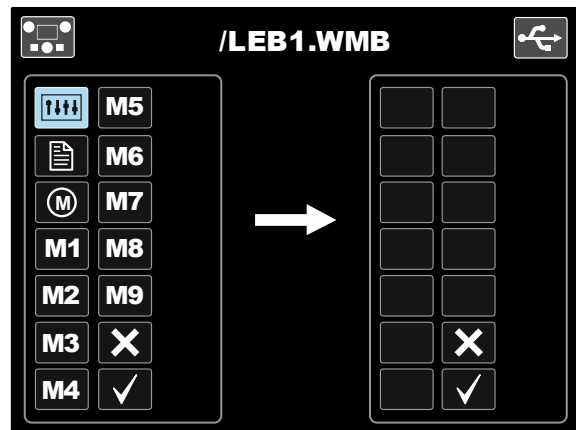

Figure 56.

- Use the Set Control [11] to highlight the data icon which will be saved in the file on a USB Memory Stick. For example: Configuration Menu icon.

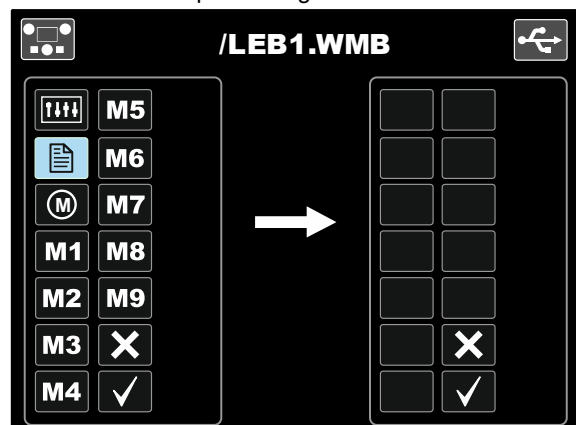

Figure 57.

- Press the Set Control [11].

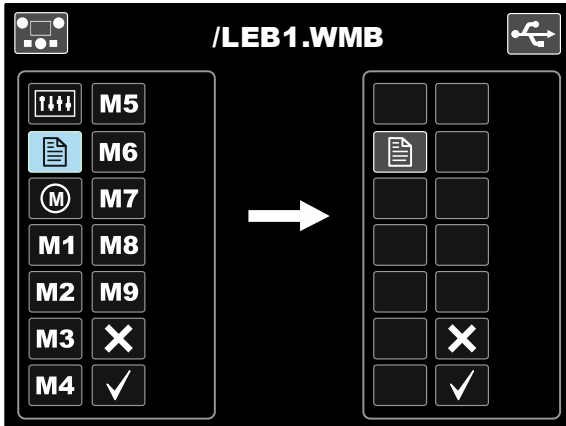

Figure 58.

- To confirm and save the data on a USB Memory Stick, highlight the Check Mark icon and then press the Right Button [12].

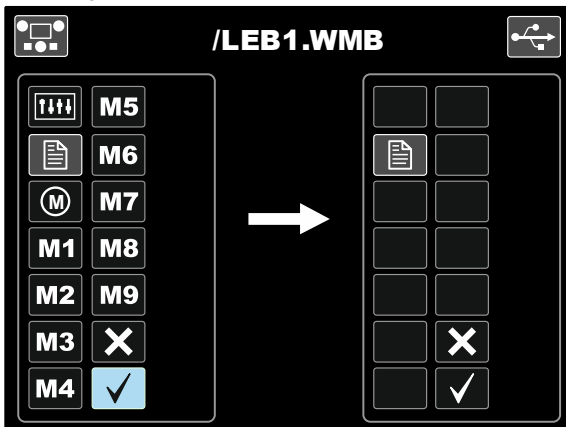

Figure 59.

- Configuration Menu is saved on a USB Memory Stick in the file "LEB1.WMB".
- To exit the USB Menu – press the Left Button [7] or disconnect the USB Memory Stick from the USB receptacle [21].

To load the data from USB Memory Stick:

- Connect the USB Memory Stick to the USB Receptacle [21].
- Use the Set Control [11] to highlight the Check Mark icon. See Figure 53.
- Press the Right Button [12] to confirm the USB Memory selection.
- Use the Set Control [11] to highlight the load data icon from the USB Memory Stick.

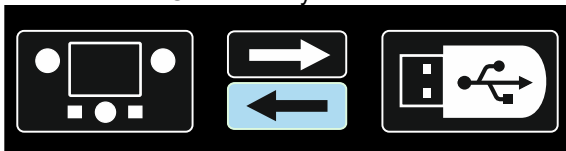

Figure 60.

- Select the file name with the data to be loaded into interface. Highlight the file icon – use Set Control [11].



Figure 61.

- Press the Right Button [12] to confirm the file selection.
- The display shows the Load Data Menu from a USB Memory Stick to User Interface.
- Use the Set Control [11] to highlight the data icon which will be loaded.

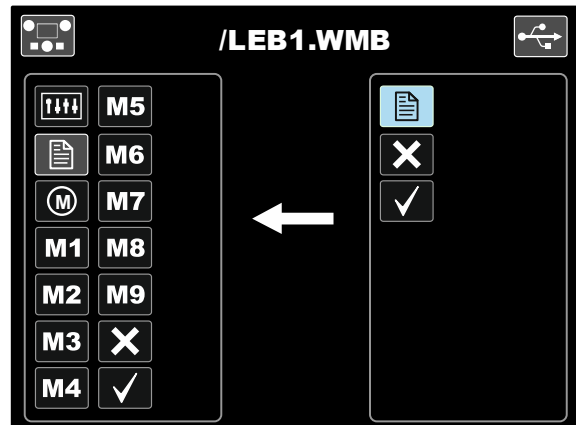

Figure 62.

- Press the Right Button [12] to confirm the data selection.
- To confirm and load the data from a USB Memory Stick, highlight the Check Mark icon and then press the Right Button [12].

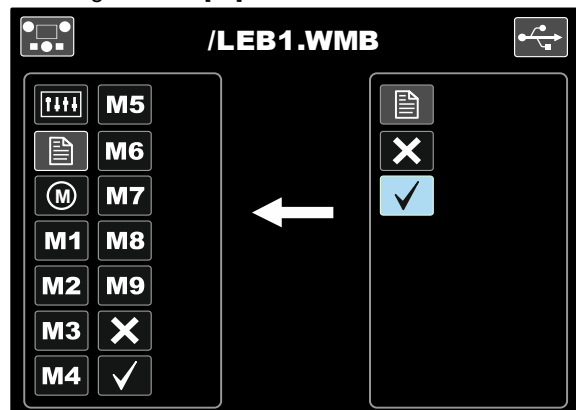

Figure 63.

- To exit the USB Menu – press the Left Button [7] or disconnect the USB Memory Stick from the USB receptacle [21].

Welding SMAW (MMA) Process

Table 13. SMAW Welding Programs







Process	Program
SMAW Soft	1
SMAW Crisp	2
SMAW Pipe	4

Note: The list of available programs depends on the power source.

Procedure of begin welding of SMAW process:

- Connect Lincoln Electric power sources using ArcLink® protocol to communication to wire feeder.
- Determine the electrode polarity for the electrode to be used. Consult the electrode data for this information.
- Depending on the polarity of using electrode, connect the work lead and the electrode holder with lead to output sockets and lock them. See the Table 14.

Table 14

		Output Socket	
POLARITY	DC (+)	The electrode holder with lead to SMAW	[4] 
		Power connection lead	Power source 
		Work lead	Power source 
	DC (-)	The electrode holder with lead to SMAW	[4] 
		Power connection lead	Power source 
		Work lead	Power source 

- Connect the work lead to the welding piece with the work clamp.
- Install the proper electrode in the electrode holder.
- Turn the input power ON.
- Set the SMAW welding program (1, 2, or 4).

Note: The list of available programs depends on the power source.

- Set the welding parameters.
- The welding machine is now ready to weld.
- By applying the principle of occupational health and safety at welding, welding can be begun.

For 1 or 2 program can set:

- Welding current [9]
- Switch on / switch off the output voltage on the output lead [10]
- Wave Controls:
 - ARC FORCE
 - HOT START

For 4 program can set:

- Welding current [9]
- Switch on / switch off the output voltage on the output lead [10]
- Wave Control:
 - ARC FORCE

ARC FORCE - the output current is temporarily increased to clear short circuit connections between the electrode and the workpiece.

- Lower values will provide less short circuit current and a softer arc. Higher settings will provide a higher short circuit current, a more forceful arc and possibly more spatter.
- Adjust range: from -10 to +10.

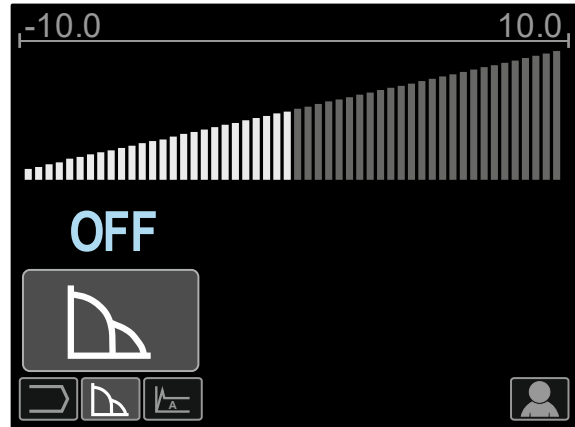

Figure 64.

HOT START – value in percentage of nominal value welding current during arc start current. The control is used to set the level of the increased current and arc start current is made easy.

- Adjust range: from 0 to +10.

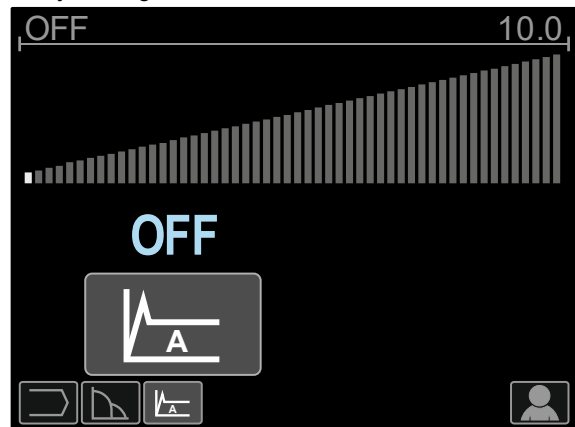

Figure 65.

Gouging

Table 15. The Welding Program - gouging

Process	Program
Gouging	9

Note: The list of available programs depends on the power source.

For 9 program can set:

- Gouging current [9]
- Switch on / switch off the output voltage on the output lead [10]

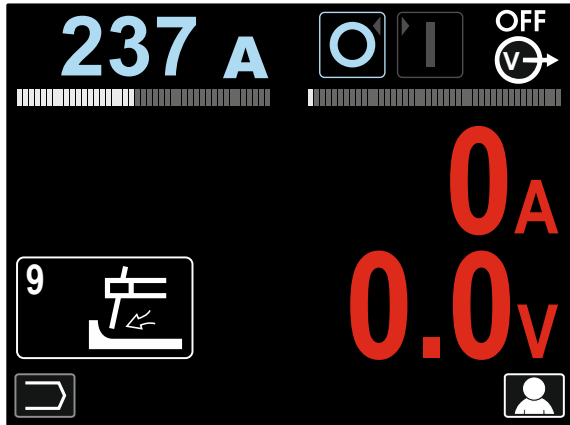

Figure 66.

Welding GTAW / GTAW-PULSE Process

Arc ignition can be achieved only by lift TIG method (contact ignition and lift ignition).

Table 16. The Welding Programs

Process	Program
GTAW	3
GTAW-PULSE	8

Note: The list of available programs depends on the power source.

Procedure of begin welding of GTAW/GTAW-PULSE process:

- Connect Lincoln Electric power sources using ArcLink® protocol to communication to wire feeder.
- Connect GTAW torch to Euro Socket [1].
Note: To connect GTAW torch, adapter TIG-EURO has to be purchased (See "Accessories" chapter).
- Connect the work lead to output sockets of the power source and lock it.
- Connect the work lead to the welding piece with the work clamp.
- Install the proper tungsten electrode in the GTAW torch.
- Turn the input power ON.
- Set the GTAW or GTAW-PULSE welding program.

Note: The list of available programs depends on the power source.

- Set the welding parameters.
- The welding machine is now ready to weld.

Note: Arc Ignition is achieved by touching the work piece with the electrode and lifting it by a few millimeters – contact ignition and lift ignition.

- By applying the principle of occupational health and safety at welding, welding can be begun.

For 3 program can set:

- Welding current [9]
- Switch on / switch off the output voltage on the output lead [10]

Note: It does not work in the 4-Step.

- Postflow Time
- 2-Step / 4-Step
- Crater [27]
- Wave Control [27]:
 - HOT START

For 8 program can set:

- Welding current [9]
- Switch on / switch off the output voltage on the output lead [10]

Note: It does not work in the 4-Step.

- Postflow Time
- 2-Step / 4-Step
- Crater
- Wave Control
 - Frequency
 - Background current
 - HOT START

The 2-Step - 4-Step changes the function of the gun's trigger.

- 2 Step trigger operation turns welding on and off in direct response to the trigger. Welding process is performed when the gun's trigger is pulled.
- 4-Step mode allows to continue welding, when the gun's trigger is released. To stop welding, the gun's trigger is pulled again. 4-step mode facilitates to making long welds.

Note: 4-Step does not work during Spot Welding.

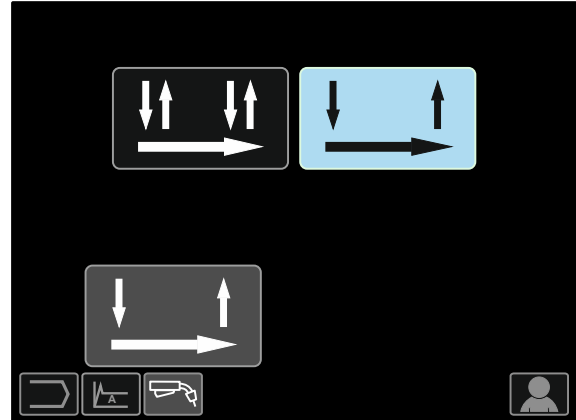

Figure 67.

HOT START – value in percentage of nominal value welding current during arc start current. The control is used to set the level of the increased current and arc start current is made easy.

- Adjust range: from 0 to +10.

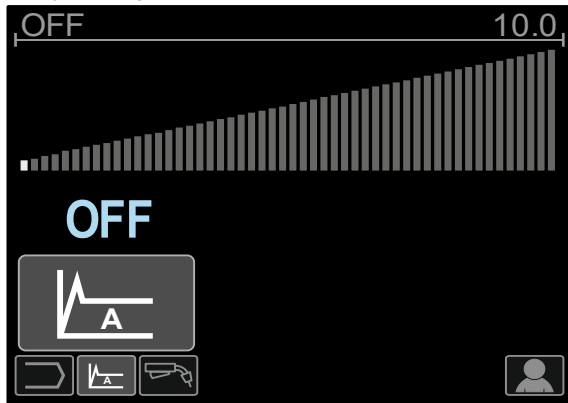

Figure 68.

Frequency influences the width of the arc and the amount of heat input to the weld. If the frequency is higher:

- Improves penetration and the microstructure of the weld.
- The arc is narrower, more stable.
- Reduces the amount of heat input to the weld.
- Reduces distortions.
- Increases welding speed.

Note: Adjust range depend on the power source.



Figure 69.

Background Current - value in percentage of nominal value welding current. Adjusts the overall heat input into the weld. Changing the background current changes the shape of the back bead.

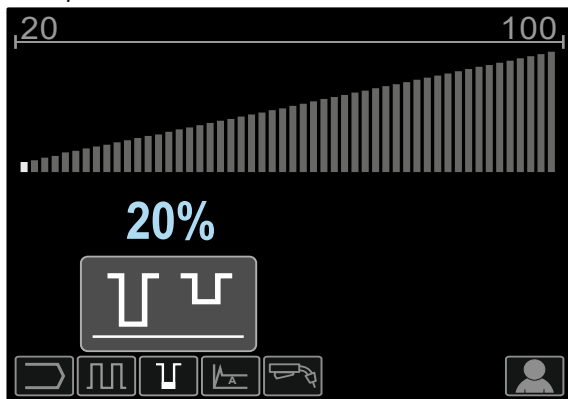

Figure 70.

Welding GMAW, FCAW-GS and FCAW-SS Process in non-synergic mode

During non-synergic mode wire feed speed and welding voltage or work (for the 40 program) are independent parameters and must be set by the user.

Table 17. GMAW and FCAW non-synergic Welding Programs

Process	Program
GMAW, standard CV	5
GMAW, "POWER MODE"	40
FCAW-GS, standard CV	7 or 155
FCAW-SS, Standard CV	6

Note: The list of available programs depends on the power source.

Procedure of begin welding of GMAW, FCAW-GS or FCAW-SS process:

- Connect Lincoln Electric power sources using ArcLink® protocol to communication to wire feeder.
- Place the machine conveniently near the work area in a location to minimize exposure to weld spatter and to avoid sharp bends in the gun cable.
- Determine the wire polarity for the wire to be used. Consult the wire data for this information.
- Connect output the gun to GMAW, FCAW-GS or FCAW-SS process to Euro Socket [1].
- Connect the work lead to output sockets of the power source and lock it.
- Connect the work lead to the welding piece with the work clamp.
- Install the proper wire.
- Install the proper drive roll.
- Manually push the wire into the gun's liner.
- Make a sure, if it is needed (GMAW, FCAW-GS process), that the gas shield has been connected.
- Turn the input power ON.
- Insert the wire into the welding gun.

! WARNING

Keep the gun cable as straight as possible when loading electrode through cable.

! WARNING

Never use defected gun.

- Check gas flow with Gas Purge Switch [19] – GMAW and FCAW-GS process.
- Close the wire drive door.
- Close the spool wire case.
- Select the right welding program. Non-synergic programs are described in the Table 17.

Note: The list of available programs depends on the power source.

- Set the welding parameters.
- The welding machine is now ready to weld.

! WARNING

The wire drive door and wire spool case have to be completely closed during welding.

! WARNING

Keep the gun cable as straight as possible when welding or loading electrode through cable.

! WARNING

Do not kink or pull cable around sharp corners.

- By applying the principle of occupational health and safety at welding, welding can be begun.

For 5, 6 and 7 program can set:

- Wire Feed Speed, WFS [9]
- The welding voltage [10]
- Burnback Time
- Run-in WFS
- Preflow Time/ Postflow Time
- Spot Time
- 2-Step/4-Step
- Crater
- Wave Control
 - Pinch

For 40 program can set:

- Wire Feed Speed, WFS [9]
- Power in kW [10]
- Burnback Time
- Run-in WFS
- Preflow Time/ Postflow Time
- Spot Time
- 2-Step/4-Step
- Crater
- Wave Control
 - Pinch

The 2-Step - 4-Step changes the function of the gun's trigger.

- 2 Step trigger operation turns welding on and off in direct response to the trigger. Welding process is performed when the gun's trigger is pulled.
- 4-Step mode allows to continue welding, when the gun's trigger is released. To stop welding, the gun's trigger is pulled again. 4-step mode facilitates to making long welds.

Note: 4-Step does not work during Spot Welding.

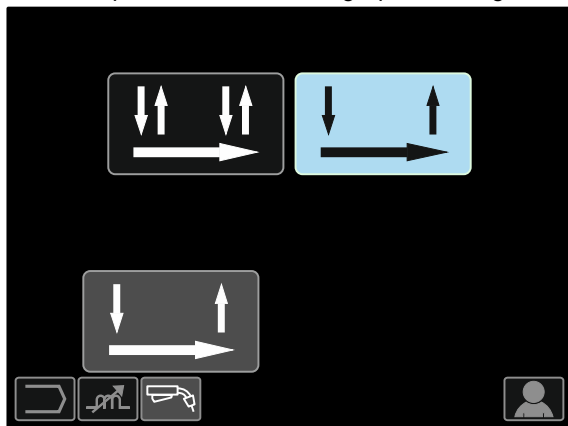

Figure 71.

Pinch controls the arc characteristics when short-arc welding. Increasing Pinch Control greater than 0.0 results in a crisper arc (more spatter) while decreasing the Pinch Control to less than 0.0 provides a softer arc (less spatter).

- Adjust range: from -10 to +10.
- Factory default, Pinch is OFF.

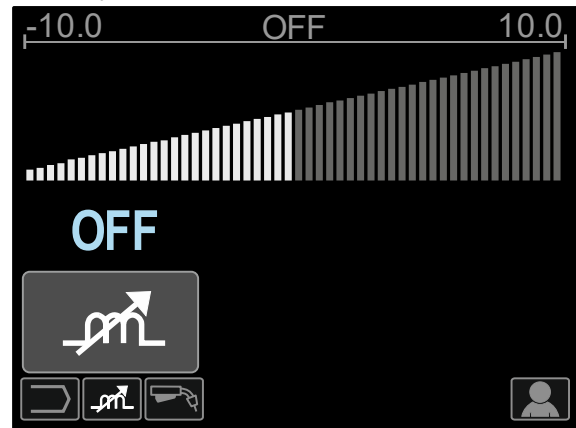

Figure 72.

Welding GMAW and FCAW-GS Process in synergic mode CV

In synergic mode, the welding voltage is not set by user. The correct welding voltage will set by the machine's software.

This value was recalled on the basis of data (input data) had been loaded:

- Wire Feed Speed, WFS [9].

Table 18. Exemplify GMAW and FCAW-GS synergic programs

Wire material	Gas	Wire diameter					
		0.8	0.9	1.0	1.2	1.4	1.6
Steel	CO ₂	93	138	10	20	24	-
Steel	ArMIX	94	139	11	21	25	107
Stainless	ArCO ₂	61	29	31	41	-	-
Stainless	Ar/He/CO ₂	63	-	33	43	-	-
Aluminum AISi	Ar	-	-	-	71	-	73
Aluminum AIMg	Ar	-	-	151	75	-	77
Metal Core	ArMIX	-	-	-	81	-	-
Cored Wire	CO ₂	-	-	-	90	-	-
Cored Wire	ArMIX	-	-	-	91	-	-

Note: The list of available programs depends on the power source.

If it is needed, the welding voltage can be adjusted by the Right Control [10]. When the Right Control is rotated, the display will show a positive or negative bar indicates if the voltage is above or below the ideal voltage.

- Preset voltage above ideal voltage

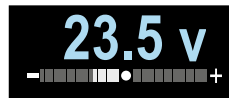

- Preset voltage at ideal voltage



- Preset voltage below ideal voltage

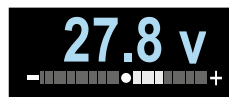

Additionally can manually set:

- Burnback
- Run-In WFS
- Preflow Time/ Postflow Time
- Spot Time
- 2-Step/4-Step
- Crater
- Wave Control
 - Pinch

The 2-Step - 4-Step changes the function of the gun's trigger.

- 2 Step trigger operation turns welding on and off in direct response to the trigger. Welding process is performed when the gun's trigger is pulled.
- 4-Step mode allows to continue welding, when the gun's trigger is released. To stop welding, the gun's trigger is pulled again. 4-step mode facilitates to making long welds.

Note: 4-Step does not work during Spot Welding.

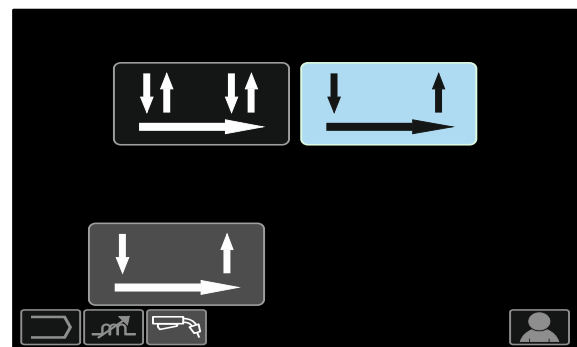

Figure 73.

Pinch controls the arc characteristics when short-arc welding. Increasing Pinch Control greater than 0.0 results in a crisper arc (more spatter) while decreasing the Pinch Control to less than 0.0 provides a softer arc (less spatter).

- Adjust range: from -10 to +10.
- Factory default, Pinch is OFF.

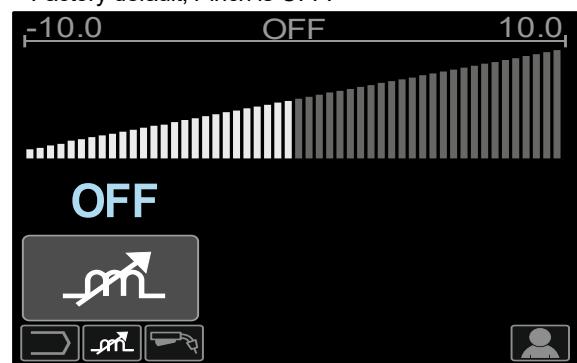

Figure 74.

Welding GMAW-P Process in synergic mode

Table 19. Exemplify GMAW-P programs

Wire material	Gas	Wire diameter					
		0.8	0.9	1.0	1.2	1.4	1.6
Steel	ArMIX	95	140	12	22	26	108
Steel (RapidArc®)	ArMIX	-	141	13	18	27	106
Steel (Precision Pulse™)	ArMIX	410	411	412	413	-	-
Stainless	ArMIX	66	30	36	46	-	-
Stainless	Ar/He/CO ₂	64	-	34	44	-	-
Metal Core	ArMIX	-	-	-	82	84	-
Ni Alloy	70%Ar/30%He	-	-	170	175	-	-
Si Bronze	Ar	-	-	192	-	-	-
Copper	ArHe	-	-	198	196	-	-
Aluminum AISi	Ar	-	-	-	72	-	74
Aluminum AIMg	Ar	-	-	152	76	-	78

Note: The list of available programs depends on the power source.

Synergic GMAW-P (Pulsed MIG) welding is ideal for low spatter, out of position. During pulse welding, the welding current continuously switches from a low level to a high level and then back again. Each pulse sends a small droplet of molten metal from the wire to the weld puddle.

Wire Feed Speed [9] is the main control parameter. As the Wire Feed Speed is adjusted, the power source adjusts the waveform parameters to maintain good welding characteristics.

Trim [10] is used as a secondary control – the value of parameter in the upper right side of display [26]. The Trim setting adjusts the arc length. Trim is adjustable from 0.50 to 1.50. 1.00 is the nominal setting.

Increasing the Trim value increases the arc length. Decreasing the Trim value decreases the arc length.

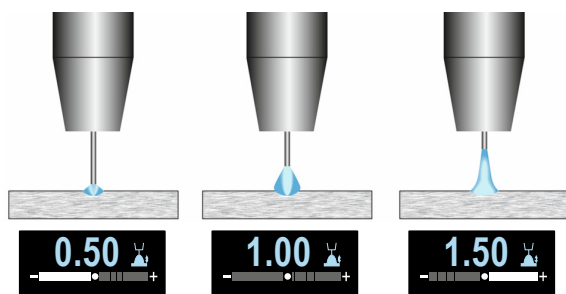

Figure 75.

When Trim is adjusted, the power source automatically recalculates the voltage, current and time of each part of the pulse waveform for the best result.

Additionally can manually set:

- Burnback
- Run-In WFS
- Preflow Time/ Postflow Time
- Spot Time
- 2-Step/4-Step
- Crater
- Wave Control
 - UltimArc™

The 2-Step - 4-Step changes the function of the gun's trigger.

- 2 Step trigger operation turns welding on and off in direct response to the trigger. Welding process is performed when the gun's trigger is pulled.
- 4-Step mode allows to continue welding, when the gun's trigger is released. To stop welding, the gun's trigger is pulled again. 4-step mode facilitates to making long welds.

Note: 4-Step does not work during Spot Welding.

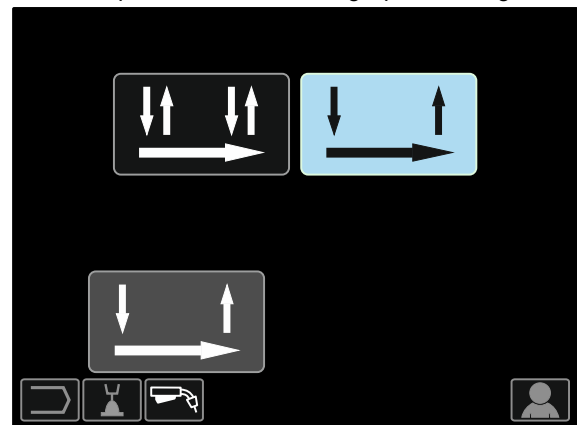

Figure 76.

UltimArc™ – for pulse welding adjusts the focus or shape of the arc. In consequence of increasing UltimArc™ Control value the arc is tight, stiff for high speed sheet metal welding.

- Adjust range: from -10 to +10
- Factory default, UltimArc™ is OFF.



Figure 77.

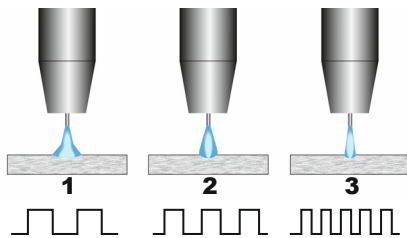

Figure 78.

1. UltimArc™ Control "-10.0": Low Frequency, Wide.
2. UltimArc™ Control OFF: Medium Frequency and Width.
3. UltimArc™ Control "+10.0": High Frequency, Focused.

Aluminum Welding GMAW- PP Process in synergic mode

Table 20. Exemplify GMAW-PP synergic programs

Wire material	Gas	Wire diameter					
		0.8	0.9	1.0	1.2	1.4	1.6
Aluminum AISi	Ar	-	-	98	99	-	100
Aluminum AlMg	Ar	-	-	101	102	-	103

Note: The list of available programs depends on the power source.

GMAW-PP (Pulse-On-Pulse®) process is used for aluminum welding. Use it to make welds with a "stacked dime" appearance, similar to GTAW welds (see Figure 79).



Figure 79.

Wire Feed Speed [9] is the main control parameter. As the Wire Feed Speed is adjusted, the power source adjusts the waveform parameters to maintain good welding characteristics. Each pulse sends a small droplet of molten metal from the wire to the weld puddle.

Trim [10] is used as a secondary control – the value of parameter in the upper right side of display [26]. The Trim setting adjusts the arc length. Trim is adjustable from 0.50 to 1.50. 1.00 is the nominal setting.

Increasing the Trim value increases the arc length. Decreasing the Trim value decreases the arc length.

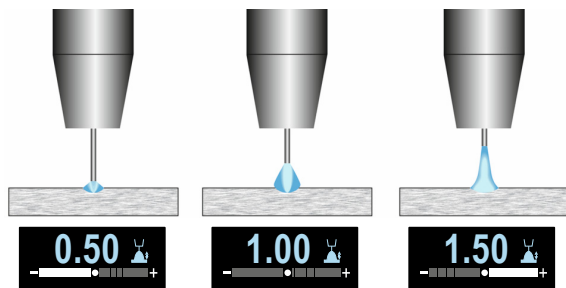

Figure 80.

When Trim is adjusted, the power source automatically recalculates the voltage, current and time of each part of the pulse waveform for the best result.

Additionally can manually set:

- Burnback Time
- Run-in WFS
- Preflow Time/ Postflow Time
- Spot Time
- 2-Step/4-Step
- Polarity
- Crater
- Wave Control:
 - Frequency

The 2-Step - 4-Step changes the function of the gun's trigger.

- 2 Step trigger operation turns welding on and off in direct response to the trigger. Welding process is performed when the gun's trigger is pulled.
- 4-Step mode allows to continue welding, when the gun's trigger is released. To stop welding, the gun's trigger is pulled again. 4-step mode facilitates to making long welds.

Note: 4-Step does not work during Spot Welding.

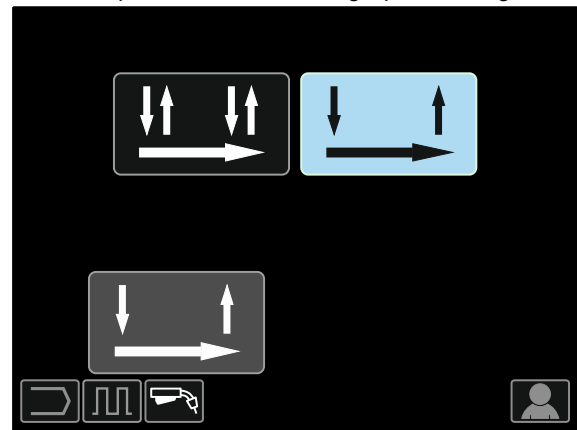

Figure 81

Frequency influences the width of the arc and the amount of heat input to the weld. If the frequency is higher:

- Improves penetration and the microstructure of the weld.
- The arc is narrower, more stable.
- Reduces the amount of heat input to the weld.
- Reduces distortions.
- Increases welding speed.

Note: Adjust range: from -10 to +10.

The frequency controls the spacing of the ripples in the weld:

- Frequency less than 0.0 – Wide weld and ripple spacing, slow travel speed. Figure 82 shows the spacing weld when the frequency is "-10".

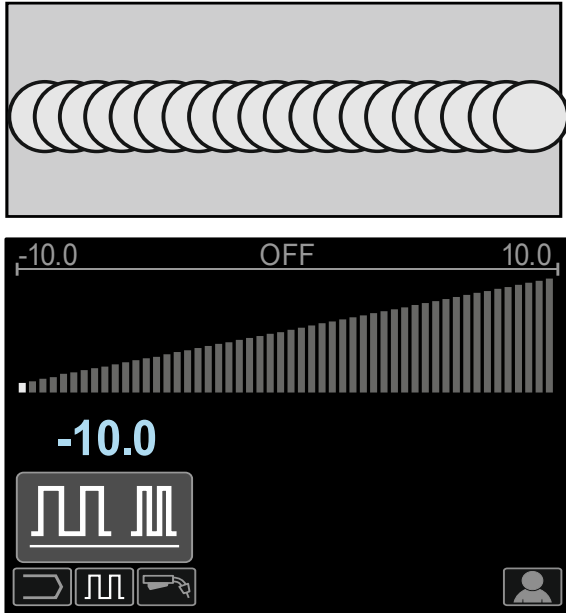

Figure 82

- Frequency greater than 0.0 – Narrow weld and ripple spacing, fast travel speed. Figure 83 shows the spacing weld when the frequency is "+10".

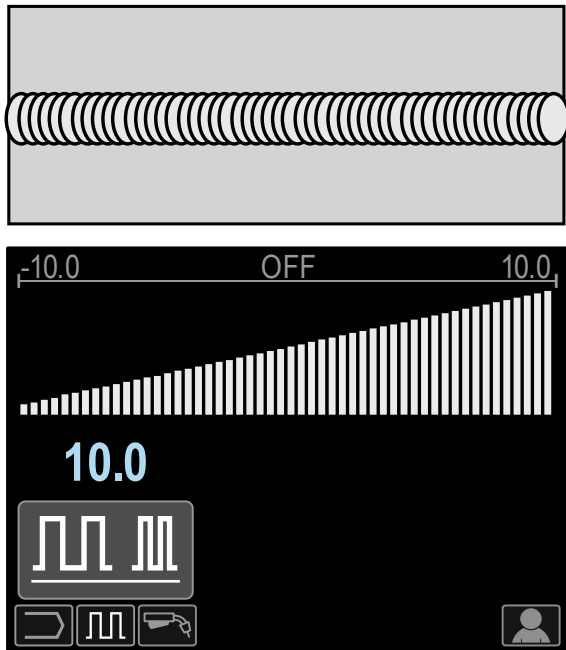

Figure 83

Welding STT® Process

Table 21. Exemplify STT® non-synergic programs

Wire material	Gas	Wire diameter					
		0.8	0.9	1.0	1.2	1.4	1.6
Steel	CO ₂	-	304	306	308	-	-
Steel	ArMIX	-	305	307	309	-	-
Stainless	HeArCO ₂	-	345	347	349	-	-
Stainless	ArMIX	-	344	346	348	-	-

Table 22. Exemplify STT® synergic programs

Wire material	Gas	Wire diameter					
		0.8	0.9	1.0	1.2	1.4	1.6
Steel	CO ₂	-	324	326	328	-	-
Steel	ArMIX	-	325	327	329	-	-
Stainless	HeArCO ₂	-	365	367	369	-	-
Stainless	ArMIX	-	364	366	368	-	-

Note: Note that STT® is available only with specially equipped Power Wave power sources, like the Power Wave 455M/STT® or the Power Wave S350 + STT® Module.

STT® (Surface Tension Transfer®) is a controlled GMAW short circuit transfer process that uses current controls to adjust the heat independent of the wire feed speed, resulting in superior arc performance, good penetration, low heat input control, reduced spatter and fumes. The STT® process makes welds that require low heat input much easier without overheating or burning through, and distortion is minimized.

STT® is also ideal for:

- Open root welding
- Welding on thin materials
- Welding on parts with poor fit-up.

During STT® welding, sense lead has to be connected to the workpiece.

Welding STT® in non-synergic mode

Manually can set:

- Wire Feed Speed, WFS [9]
- Burnback Time
- Run-in WFS
- Preflow Time/ Postflow Time
- Spot Time
- 2-Step/4-Step
- Crater
- Wave Controls:
 - Peak Current
 - Background Current
 - TailOut
 - HOT START

During the STT® welding in non-synergic mode, voltage control is disabled.

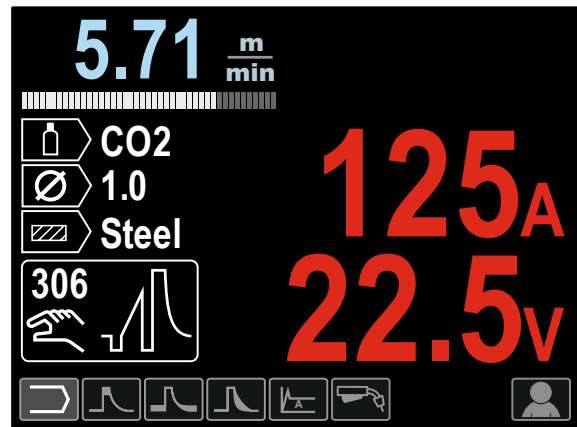

Figure 84.

Welding STT® in synergic mode

In synergic mode, the welding parameters are optimally set to the Wire Feed Speed [9].

Wire Feed Speed controls the deposition rate.

Trim [10] is used as a secondary control – the value of parameter in the upper right side of display [26]. The Trim setting adjusts the arc length. Trim is adjustable from 0.50 to 1.50. 1.00 is the nominal setting.

Additionally can manually set:

- Burnback Time
- Run-in WFS
- Preflow Time/ Postflow Time
- Spot Time
- 2-Step/4-Step
- Crater
- Wave Controls:
 - UltimArc™
 - HOT START.

The 2-Step - 4-Step changes the function of the gun's trigger.

- 2 Step trigger operation turns welding on and off in direct response to the trigger. Welding process is performed when the gun's trigger is pulled.
- 4-Step mode allows to continue welding, when the gun's trigger is released. To stop welding, the gun's trigger is pulled again. 4-step mode facilitates to making long welds.

Note: 4-Step does not work during Spot Welding.

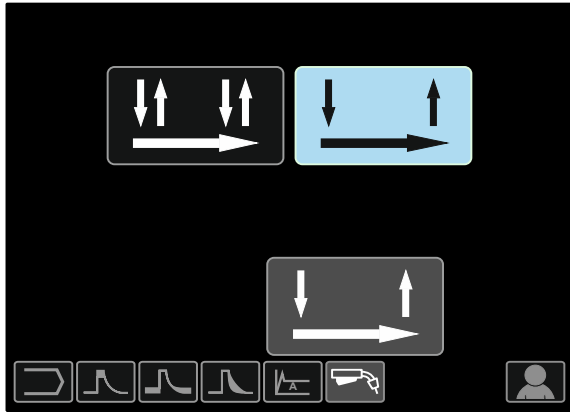

Figure 85

HOT START – value in percentage of nominal value welding current during arc start current. The control is used to set the level of the increased current and arc start current is made easy.

- Adjust range: from 0 to +10.

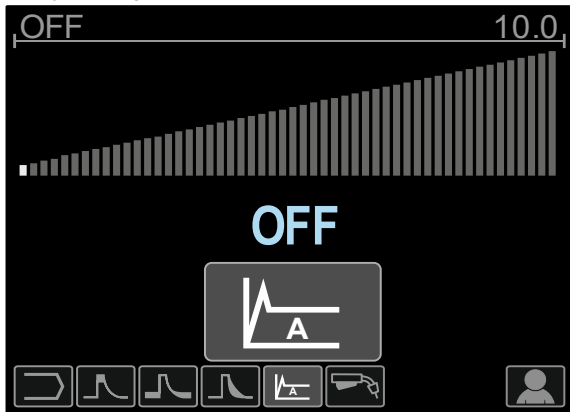

Figure 86

TailOut provides additional heat into the weld without increasing the arc length or the droplet size. Higher tailout values improve wetting and may give faster travel speeds.

- Adjust Range: from 0 to +10.



Figure 87

Background Current adjusts the overall heat input into the weld. Changing the background current changes the shape of the back bead. 100% CO₂ requires less background current than when welding with blended shielding gases.

Note: Range depends on the power source.

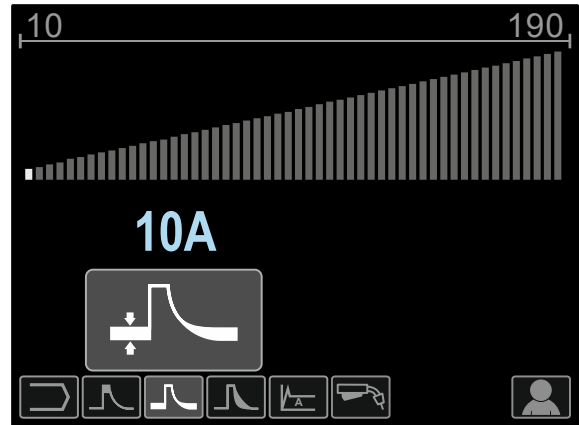

Figure 88

Peak Current controls the arc length, which also affects the shape of the root. When using 100% CO₂, the peak current will be higher than when welding with blended shielding gases. A longer arc length is required with CO₂ to reduce spatter.

Note: Range depends on the power source.



Figure 89

UltimArc™ – for pulse welding adjusts the focus or shape of the arc. In consequence of increasing UltimArc™ Control value the arc is tight, stiff for high speed sheet metal welding.

- Adjust range: from -10 to +10
- Factory default, UltimArc™ is OFF.



Figure 90.

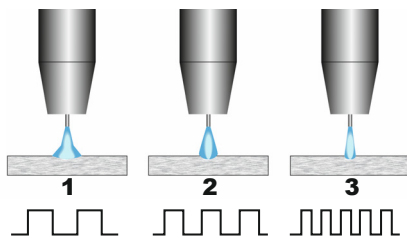

Figure 91.

1. UltimArc™ Control "-10.0": Low Frequency, Wide.
2. UltimArc™ Control OFF: Medium Frequency and Width.
3. UltimArc™ Control "+10.0": High Frequency, Focused.

Wire Spool Loading

Wire spool type S300 and BS300 can be installed on the wire spool support without adapter.

Wire spool type S200, B300 or Readi-Reel® can be installed, but the applicable adapter must be purchased. The applicable adapter can be purchased separately (see "Accessories" chapter).

Wire Spool Type S300 & BS300 Loading

WARNING

Turn the input power OFF at the welding power source before installation or changing a wire spool.

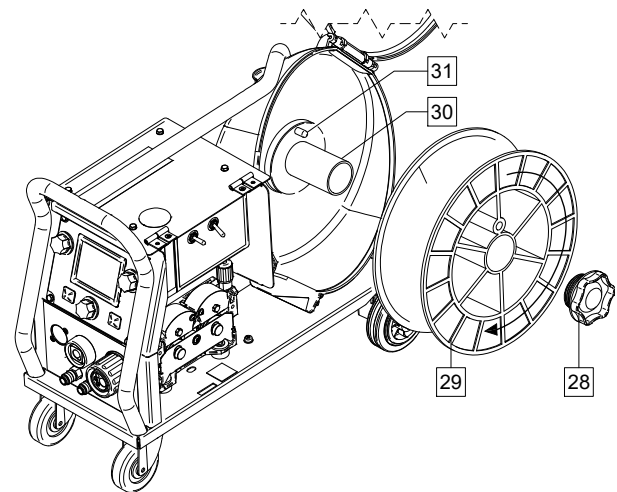

Figure 92.

- Turn the input power OFF.
- Open the spool wire case.
- Unscrew the Locking Nut [28] and remove it from the Spindle [30].
- Place the spool type S300 or BS300 [29] on the Spindle [30] making certain the Spindle Brake Pin [31] is put in the hole in back side of spool type S300 or SB300.

WARNING

Position the spool type S300 or SB300 so that it will rotate in a direction when feeding so as to be de-reeled from bottom of the spool.

- Re-install the locking nut [28]. Make sure that the locking nut is tightened.

Wire Spool Type S200 Loading

! WARNING

Turn the input power OFF at the welding power source before installation or changing a wire spool.

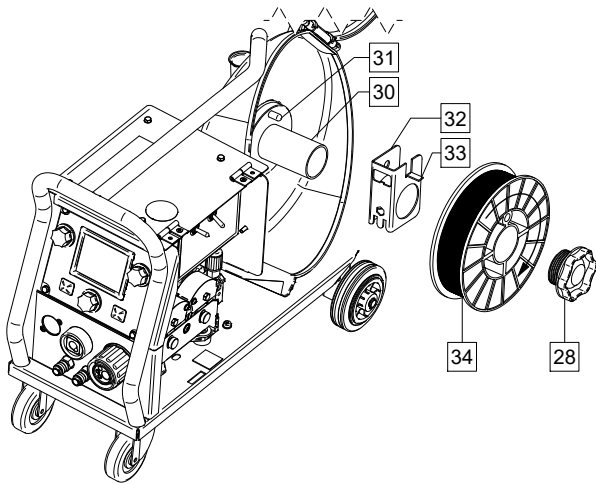

Figure 93.

- Turn the input power OFF.
- Open the spool wire case.
- Unscrew the Locking Nut [28] and remove it from the Spindle [30].
- Place the adapter of spool type S200 [32] on the spindle [30] making certain the spindle brake pin [31] is put in the hole in back side of the adapter [32]. The adapter of spool type S200 can be purchased separately (see "Accessories" chapter).
- Place the spool type S200 [34] on the spindle [30] making certain that the adapter brake pin [33] is put in the hole in the back side of the spool.

! WARNING

Position the spool type S200 so that it will rotate in a direction when feeding so as to be de-reeled from bottom of the spool.

- Re-install the locking nut [28]. Make sure that the locking nut is tightened.

Wire Spool Type B300 Loading

! WARNING

Turn the input power OFF at the welding power source before installation or changing a wire spool.

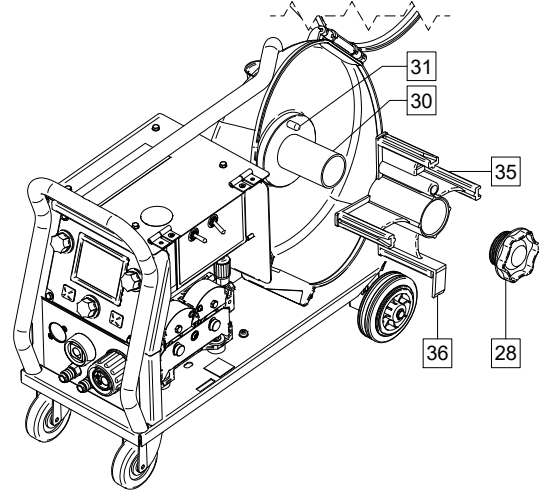

Figure 94.

- Turn the input power OFF.
- Open the spool wire case.
- Unscrew the Locking Nut [28] and remove it from the Spindle [30].
- Place the adapter of spool type B300 [35] on the spindle [30]. Make certain that the spindle brake pin [31] is put in the hole in the back side of the adapter [35]. The adapter of spool type B300 can be purchased separately (see "Accessories" chapter).
- Re-install the locking nut [28]. Make sure that the locking nut is tightened.

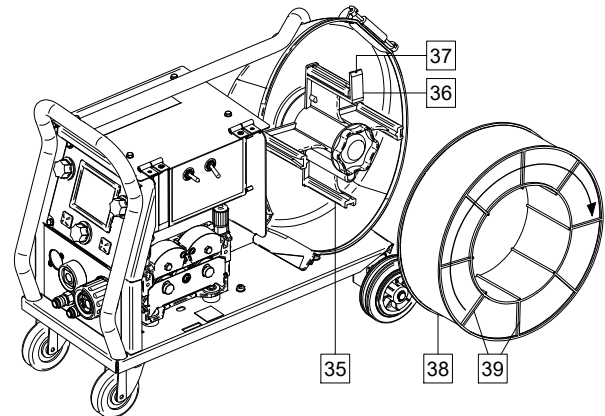

Figure 95.

- Rotate the spindle and adapter so the retaining spring [36] is at the 12 o'clock position.
- Place the spool type B300 [38] on the adapter [35]. Set one of the B300 inside cage wires [39] on the slot [37] in the retaining spring tab [36] and slide the spool onto the adapter.

! WARNING

Position the spool type B300 so that it will rotate in a direction when feeding so as to be de-reeled from bottom of the spool.

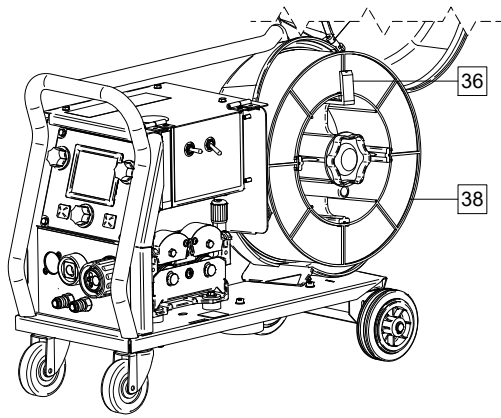

Figure 96.

Wire Spool Type Readi-Reel® Loading

! WARNING

Turn the input power OFF at the welding power source before installation or changing a wire spool.

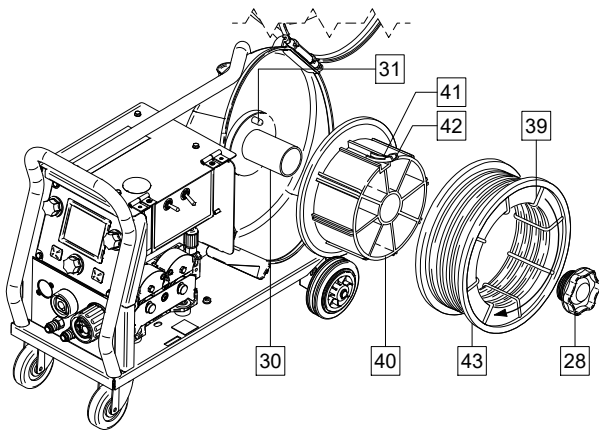

Figure 97.

- Turn the input power OFF.
- Open the spool wire case.
- Unscrew the Locking Nut [28] and remove it from the Spindle [30].
- Place the adapter of spool type Readi-Reel® [40] on the spindle [30]. Make certain that the spindle brake pin [31] is put in the hole in the back side of the adapter [40]. The adapter of spool type Readi-Reel® can be purchased separately (see "Accessories" chapter).
- Re-install the locking nut [28]. Make sure that the locking nut is tightened.
- Rotate the spindle and adapter so the retaining spring [41] is at the 12 o'clock position.
- Place the spool type Readi-Reel® [43] on the adapter [40]. Set one of the Readi-Reel® inside cage wires [39] on the slot [42] in the retaining spring tab [41].

! WARNING

Position the spool type Readi-Reel® so that it will rotate in a direction when feeding so as to be de-reeled from bottom of the spool.

Loading the Electrode Wire

- Turn the input power OFF.
- Open the spool wire case.
- Unscrew the locking nut of the sleeve.
- Load the spooled wire on the sleeve such that the spool turns clockwise when the wire is fed into the wire feeder.
- Make sure that the spindle brake pin [38] goes into the fitting hole on the spool.
- Screw in the locking nut of the sleeve.
- Open the wire drive door.
- Put on the wire roll using the correct groove corresponding to the wire diameter.
- Free the end of the wire and cut off the bent end making sure it has no burr.

! WARNING

Sharp end of the wire can hurt.

- Rotate the wire spool clockwise and thread the end of the wire into the wire feeder as far as the Euro Socket.
- Adjust force of pressure roll of the wire feeder properly.

Adjustments of Brake Torque of Sleeve

To avoid spontaneous unrolling of the welding wire the sleeve is fitted with a brake. Adjustment is carried by rotation of its screw M10, which is placed inside of the sleeve frame after unscrewing the locking nut of the sleeve.

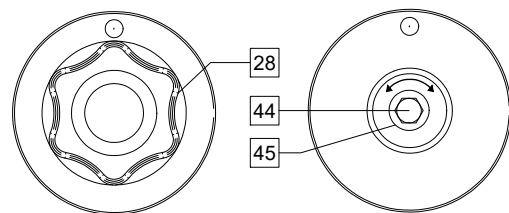

Figure 98.

- 28. Locking Nut.
- 44. Adjusting Screw M10.
- 45. Pressing Spring.

Turning the screw M10 clockwise increases the spring tension and you can increase the brake torque

Turning the screw M10 anticlockwise decreases the spring tension and you can decrease the brake torque.

After finishing of adjustment, you should screw in the locking nut again.

Adjusting Pressure Roll Force

The pressure arm controls the amount of force the drive rolls exert on the wire.

Pressure force is adjusted by turning the adjustment nut clockwise to increase force, counterclockwise to decrease force. Proper adjustment of pressure arm gives the best welding performance.

WARNING

If the roll pressure is too low the roll will slide on the wire. If the roll pressure is set too high the wire may be deformed, which will cause feeding problems in the welding gun. The pressure force should be set properly. Decrease the pressure force slowly until the wire just begins to slide on the drive roll and then increase the force slightly by turning of the adjustment nut by one turn.

Inserting Electrode Wire into Welding Gun

- Turn the input power OFF.
- Depending on welding process, connect the proper gun to the Euro Socket, the rated parameters of the gun and of the welding machine should be matched.
- Remote the nozzle from the gun and contact tip or protection cap and contact tip. Next, straighten the gun out flat.
- Insert the wire through the guide tube, over the roller and through the guide tube of Euro Socket into liner of gun. The wire can be pushed into the liner manually for a few centimetres, and should feed easily and without any force.

WARNING

If force is required it is likely that the wire has missed the liner of gun.

- Turn the input power ON.
- Depress the gun trigger to feed the wire through the gun liner until the wire comes out of the threaded end. Or the Cold Inch / Gas Purge Switch [19] can be used – keep in "Cold Inch" position until the wire comes out of the threaded end.
- When trigger or the Cold Inch / Gas Purge Switch [19] is released spool of wire should not unwind.
- Adjust wire spool brake accordingly.
- Turn the welding machine off.
- Install a proper contact tip.
- Depending on the welding process and the type of the gun, install the nozzle (GMAW process, FCAW-GS process) or protection cap (FCAW-SS process).

WARNING

Take precaution to keep eyes and hands away from the end of the gun while the wire is being come out of the threaded end.

Changing Driving Rolls

WARNING

Turn the input power OFF at the welding power source before installation or changing drive rolls and/or guides.

PF44 and PF46 are equipped with drive roll V1.0/V1.2 for steel wire.

For others wire sizes, is available the proper drive rolls kit (see "Accessories" chapter) and follow instructions:

- Turn the input power OFF.
- Release the pressure roll levers [46].
- Unscrew the fastening caps [47].
- Open the protection cover [48].
- Change the drive rolls [49] with the compatible ones corresponding to the used wire.

WARNING

Be sure that the gun liner and contact tip are also sized to match the selected wire size.

WARNING

For wires with the diameter larger than 1.6mm, the following parts are to be changed:

- The guide tube of the feeding console [50] and [51].
- The guide tube of the Euro Socket [52].
- Replace and tighten the protection cover [48] to the drive rolls.
- Screw fastening caps [47].
- Manually feed the wire from the wire reel, the wire through the guide tubes, over the roller and through the guide tube of Euro Socket into liner of gun.
- Lock the pressure roll levers [46].

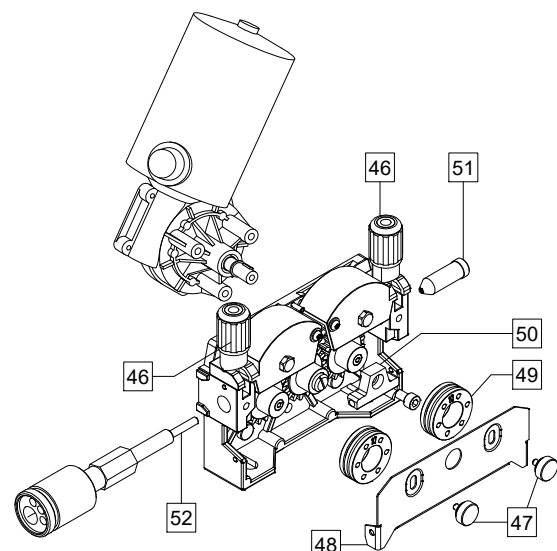

Figure 99.

Gas Connection



WARNING

- CYLINDER may explode if damaged.
- Always fix the gas cylinder securely in an upright position, against a cylinder wall rack or purpose-made cylinder cart.
- Keep cylinder away from areas where it may be damaged, heated, or electrical circuits to prevent possible explosion or fire.
- Keep cylinder away from welding or other live electrical circuits.
- Never lift welder with cylinder attached.
- Never allow welding electrode to touch cylinder.
- Build up of shielding gas may harm health or kill. Use in a well-ventilated area to avoid gas accumulation.
- Close the gas cylinder valves thoroughly when not in use to avoid leaks.

WARNING

The welding machine supports all suitable shielding gases at a maximum pressure of 5,0 bar.

WARNING

Before use, make sure that the gas cylinder contains gas suitable for the intended purpose.

- Turn off input power at the welding power source.
- Install a proper gas flow regulator to the gas cylinder.
- Connect the gas hose to the regulator using the hose clamp.
- The other end of gas hose connect to the Gas Connector [13] located on the rear panel of the machine.
- Turn on input power at the welding power source.
- Turn to open the gas cylinder valve.
- Adjust the shielding gas flow of the gas regulator.
- Check gas flow with Gas Purge Switch [19].

WARNING

To weld GMAW process with CO₂ shielding gas, CO₂ gas heater should be used.

Maintenance

WARNING

For any repair operations, modifications or maintenance, it is recommended to contact the nearest Technical Service Center or Lincoln Electric. Repairs and modifications performed by unauthorized service or personnel will cause the manufacturer's warranty to become null and void.

Any noticeable damage should be reported immediately and repaired.

Routine maintenance (everyday)

- Check condition of insulation and connections of the work leads and insulation of power lead. If any insulation damage exists replace the lead immediately.
- Remove the spatters from the welding gun nozzle. Spatters could interfere with the shielding gas flow to the arc.
- Check the welding gun condition: replace it, if necessary.
- Check condition and operation of the cooling fan. Keep clean its airflow slots.

Periodic maintenance (every 200 working hours but at least once a year)

Perform the routine maintenance and, in addition:

- Keep the machine clean. Using a dry (and low pressure) airflow, remove the dust from the external case and from the cabinet inside.
- If it is required, clean and tighten all weld terminals.

The frequency of the maintenance operations may vary in accordance with the working environment where the machine is placed.

WARNING

Do not touch electrically live parts.

WARNING

Before the case of machine will be removed, the machine has to be turned off and the power lead has to be disconnected from mains socket.

WARNING

Mains supply network must be disconnected from the machine before each maintenance and service. After each repair, perform proper tests to ensure safety.

Error's Message

Table 23. Interface Components

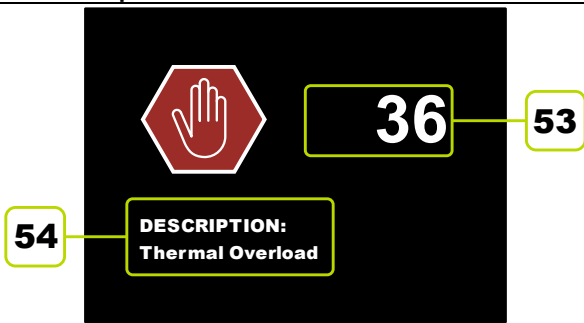
 <p>Figure 100.</p>	Interface description
	<p>53. Error Code 54. Error description.</p>

The following is a partial list of possible error codes. For a complete listing contact with Local Lincoln Authorized Field Service.

Table 24. Exemplary Error Codes.

Error Code	Symptoms	Possible Cause	Recommended Course of Action
6	Power source is not connected.	The User Interface cannot seem to communicate with the Power Source.	<ul style="list-style-type: none"> Check cable connections between the power source and the user interface.
36	The machine has shut down because it has overheated.	System detected a temperature level beyond the normal system operating limit.	<ul style="list-style-type: none"> Be sure process does not exceed duty cycle limit of the machine. Check the setup for proper air flow around and through the system. Check that the system has been properly maintained, including removal of accumulated dust and dirt from the intake and outlet louvers.
81	Motor overload, long term.	The wire drive motor has overheated. Check that the electrode slides easily through the gun and cable.	<ul style="list-style-type: none"> Remove tight bends from the gun and cable. Check that the spindle brake is not too tight. Verify the adequacy of the electrode to the welding process. Verify a high quality electrode is being used. Check drive rolls alignment and gears. Wait for the error to reset and the motor to cool (approximately 1 minute).

WARNING

If for any reason you do not understand the test procedures or are unable to perform the tests/repairs safely, contact your Local Lincoln Authorized Field Service Facility for technical troubleshooting assistance before you proceed.

Customer Assistance Policy

The business of The Lincoln Electric Company is manufacturing and selling high quality welding equipment, consumables, and cutting equipment. Our challenge is to meet the needs of our customers and to exceed their expectations. On occasion, purchasers may ask Lincoln Electric for advice or information about their use of our products. We respond to our customers based on the best information in our possession at that time. Lincoln Electric is not in a position to warrant or guarantee such advice, and assumes no liability, with respect to such information or advice. We expressly disclaim any warranty of any kind, including any warranty of fitness for any customer's particular purpose, with respect to such information or advice. As a matter of practical consideration, we also cannot assume any responsibility for updating or correcting any such information or advice once it has been given, nor does the provision of information or advice create, expand or alter any warranty with respect to the sale of our products

Lincoln Electric is a responsive manufacturer, but the selection and use of specific products sold by Lincoln Electric is solely within the control of, and remains the sole responsibility of the customer. Many variables beyond the control of Lincoln Electric affect the results obtained in applying these types of fabrication methods and service requirements.

Subject to Change – This information is accurate to the best of our knowledge at the time of printing. Please refer to www.lincolnelectric.com for any updated information.

WEEE

07/06

English



Do not dispose of electrical equipment together with normal waste!

In observance of European Directive 2012/19/EC on Waste Electrical and Electronic Equipment (WEEE) and its implementation in accordance with national law, electrical equipment that has reached the end of its life must be collected separately and returned to an environmentally compatible recycling facility. As the owner of the equipment, you should get information on approved collection systems from our local representative. By applying this European Directive you will protect the environment and human health!

Spare Parts

12/05

Part List reading instructions

- Do not use this part list for a machine if its code number is not listed. Contact the Lincoln Electric Service Department for any code number not listed.
- Use the illustration of assembly page and the table below to determine where the part is located for your particular code machine.
- Use only the parts marked "X" in the column under the heading number called for in the assembly page (# indicate a change in this printing).

First, read the Part List reading instructions above, then refer to the "Spare Part" manual supplied with the machine, that contains a picture-descriptive part number cross-reference.

REACH

11/19

Communication in accordance with Article 33.1 of Regulation (EC) No 1907/2006 – REACH.

Some parts inside this product contain:

Bisphenol A, BPA,	EC 201-245-8, CAS 80-05-7
Cadmium,	EC 231-152-8, CAS 7440-43-9
Lead,	EC 231-100-4, CAS 7439-92-1
Phenol, 4-nonyl-, branched,	EC 284-325-5, CAS 84852-15-3

in more than 0,1% w/w in homogeneous material. These substances are included in the "Candidate List of Substances of Very High Concern for Authorisation" of REACH.

Your particular product may contain one or more of the listed substances.

Instructions for safe use:

- use according to Manufacturer instructions, wash hands after use;
- keep out of reach of children, do not put in mouth,
- dispose in accordance with local regulations.

Authorized Service Shops Location

09/16

- The purchaser must contact a Lincoln Authorized Service Facility (LASF) about any defect claimed under Lincoln's warranty period.
- Contact your local Lincoln Sales Representative for assistance in locating a LASF or go to www.lincolnelectric.com/en-gb/Support/Locator.

Electrical Schematic

Refer to the "Spare Part" manual supplied with the machine.

Suggested Accessories

K14125-1	Kit - Remote Control for PF44 (12PIN).
K10095-1-15M	Remote control (welding voltage & wire feeder speed WFS).
K14091-1	Remote MIG
K870	Foot Amptrol
K14127-1	Cart for PF40/42/44/46.
K14111-1	Kit - Gas Flow Regulator.
K14121-1	Replaceable Front Panel with User Interface, A+.
K14122-1	Replaceable Front Panel with User Interface, B.
K14123-1	Replaceable Front Panel with User Interface, B+.
K14124-1	Case of remote control (PENDANT).
K14131-1	ArcLink® "T" Connector Kit.
K14135-1	ArcLink® "T" Power Connector Kit
K2909-1	6-PIN/12-PIN adapter.
K14132-1	5-PIN/12-PIN adapter.
K14128-1	Kit – Lifting Eye.
K14042-1	Adapter for spool type S200.
K10158-1	Adapter for spool type B300.
K363P	Adapter for spool type Readi-Reel®.
K10349-PG-xxM	Source/wire feeder cable (gas). Available in 5, 10 or 15m (Speedtec, Power Wave S350, S500 CE).
K10349-PGW-xxM	Source/wire feeder cable (gas and water). Available in 5, 10 or 15m. (Speedtec, Power Wave S350, S500 CE).
K10348-PG-xxM	Source/wire feeder cable (gas). Available in 5, 10 or 15m (Power Wave 455M, Power Wave 455M/STT, Power Wave 405M).
K10348-PGW-xxM	Source/wire feeder cable (gas and water). Available in 5, 10 or 15m (Power Wave 455M, Power Wave 455M/STT, Power Wave 405M).
KP10519-8	TIG – Euro adapter.
K10315-26-4	TIG Torch.
FL060583010	FLAIR 600 Gouging torch with mounted lead 2,5m.
E/H-400A-70-5M	Welding cable with electrode holder to SMAW process - 5m.

Drive rolls to 4 driven rolls

KP14017-0.8	Solid wires: V0.6 / V0.8
KP14017-1.0	V0.8 / V1.0
KP14017-1.2	V1.0 / V1.2
KP14017-1.6	V1.2 / V1.6
KP14017-1.2A	Aluminum wires: U1.0 / U1.2
KP14017-1.6A	U1.2 / U1.6
KP14017-1.1R	Cored wires: VK0.9 / VK1.1
KP14017-1.6R	VK1.2 / VK1.6

LINC GUN™

K10413-36	Gas cooled gun LG 360 G (335A 60%) – 3m, 4m, 5m.
K10413-42	Gas cooled gun LG 420 G (380A 60%) – 3m, 4m, 5m.
K10413-410	Water cooled gun LG 410 W (350A 100%) - 3m, 4m, 5m.
K10413-500	Water cooled gun LG 500 W (450A 100%) - 3m, 4m, 5m.

Connection Diagram

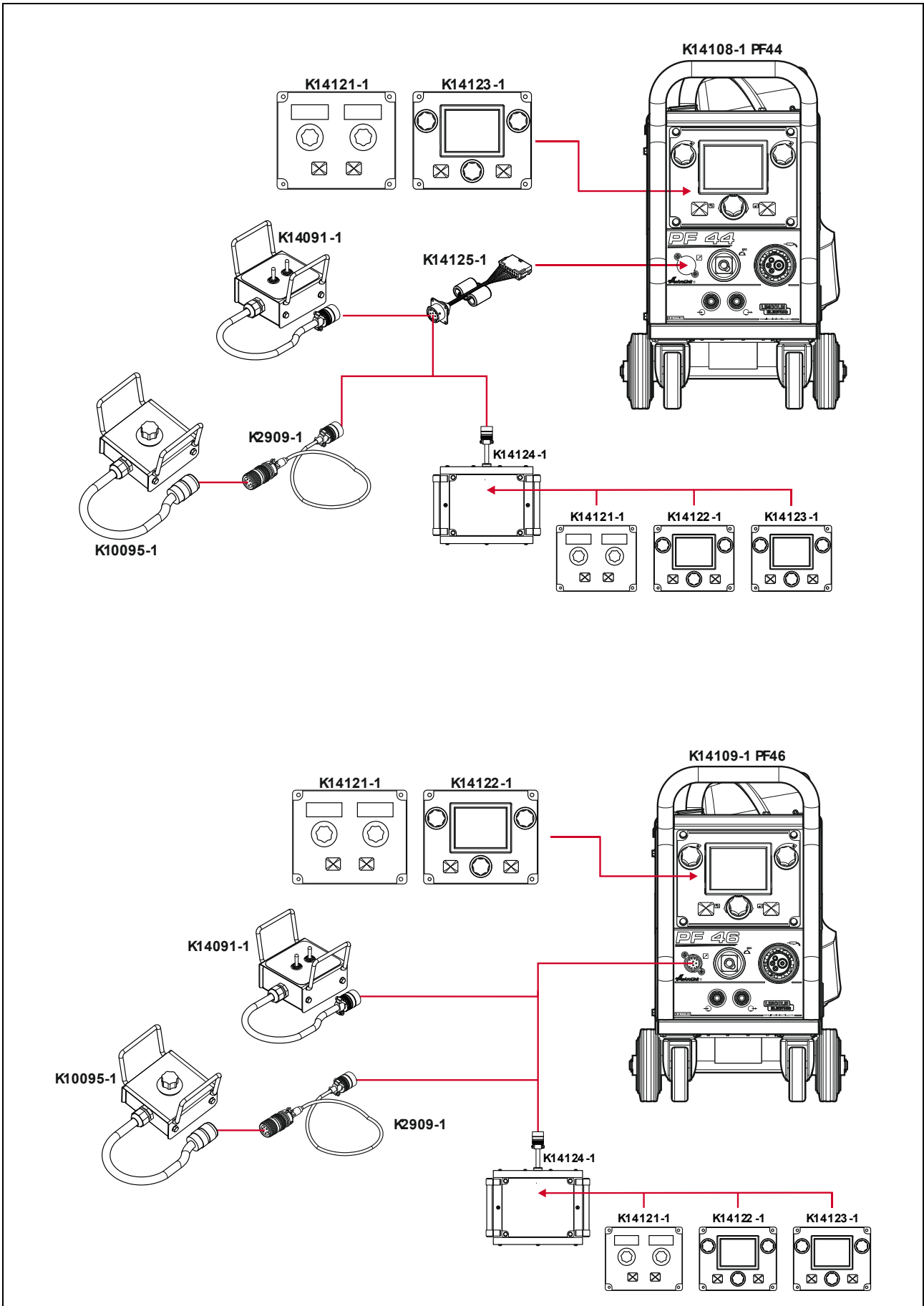

K14108-1 PF44
K14109-1 PF46

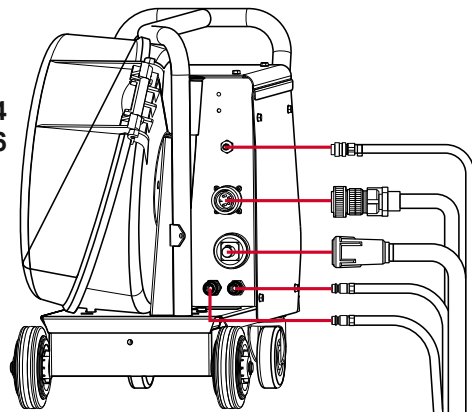

 ArcLink®

K10348-PGW-XXM
K10348-PG-XXM

K10349-PGW-XXM
K10349-PG-XXM

