

1921990
R01

Zeta G200

Zeta G200x

**Operating
manual**

Operating manual – Brugsanvisning – Gebrauchsanweisung – Manual de instrucciones – Käyttöohje – Manuel d'utilisation – Manuale d'uso – Gebruiksaanwijzing – Bruksanvisning – Instrukcja obsługi – Manual de utilização – Инструкции по эксплуатации – Bruksanvisning – 操作手册

1

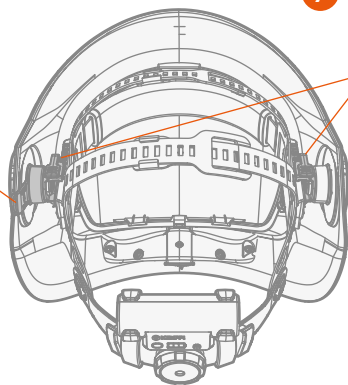
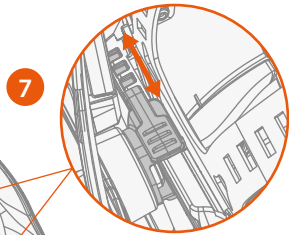
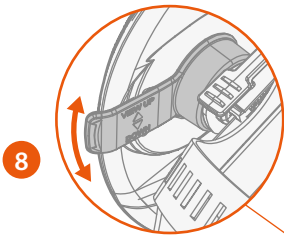
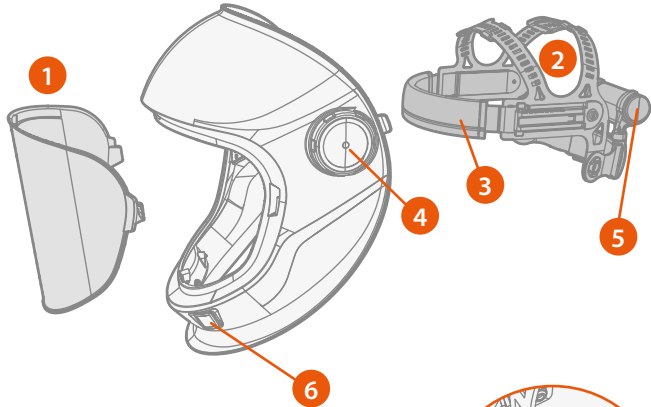
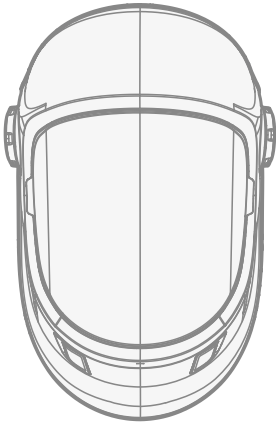

1. Introduction



1.1 Zeta G200 and G200x

Zeta G200 and G200x grinding helmets are designed for grinding, surface finishing or inspection. They are not designed to be used in welding applications or sandblasting.

Zeta G200 and G200x grinding helmets provide protection for the user's eyes and face. The Zeta G200x model has also integrated LED work lights.

1.2 About this manual

Read this manual carefully before using the equipment for the first time. Pay particular attention to the safety instructions.

	Note	Gives the user a piece of information of particular importance.
	Caution	Describes a situation that may result in damage to the equipment or system.
	Warning	Describes a potentially dangerous situation that may result in personal damage or fatal injury.

1.3 Disclaimer

While every effort has been made to ensure that the information contained in this guide is accurate and complete, no liability can be accepted for any errors or omissions. Kemppi reserves the right to change the specification of the product described at any time without prior notice. Do not copy, record, reproduce or transmit the contents of this guide without prior permission from Kemppi.

2. Safety

Warning:

- It is strictly forbidden to use any other than Kemppi branded parts or accessories with Kemppi's personal protection equipment. If you do not respect this safety regulation, serious damage for your health may occur.

- We recommend a usage period of 5 years. The period of use depends on various factors such as use, cleaning, storage and maintenance. Inspect the helmet before each use. Replace damaged or worn parts.
- Use all adjustment features for maximum protection.
- Never use a scratched or damaged visor.
- Materials which may come into contact with the wearer's skin may cause allergic reactions to susceptible individuals.
- Only operate this product within the temperature range -5...+55 °C.
- The product is not intended for use in environments with a risk of explosion.
- The helmet does not protect against explosive devices or corrosive liquids.
- The helmet gives designed protection against high speed particles only at room temperature (EN166 designation B) and only when all helmet components are properly attached, as described in the manual.
- When helmet is worn over any spectacles, they may transmit the impact of high speed particles, thus creating a hazard to the wearer.
- If the symbols of the marking are not common to different parts of the protection equipment, the lower protection level shall be assigned to the complete protection equipment.

3. Parts

- Grinding visor
- Headband, adjustable
- Sweatband, washable
- Opening/closing tightness adjuster
- LED work light battery unit (G200x model only)
- LED work lights (G200x model only)
- Distance slide adjusters (connect the headband to the helmet and adjust the distance of the helmet from the face)
- Viewing angle adjuster

4. Using helmet features

4.1 Taking into use 2

1. Adjust the helmet for your head:
 - A. Use the top bands to adjust how deep the helmet sits (c).
 - B. Use the distance slide adjuster to change the distance of the helmet from your face (b). Ensure that the helmet is comfortably as close as possible to your face and that both sides are equally positioned.
 - C. Turn the knob in the rear to tighten and secure the headband (a).
2. Turn the viewing angle adjuster to tilt the viewing angle upwards or downwards. (d)
3. Adjust the helmet's opening/closing tightness if needed (e).

4.2 Using work lights (G200x) 4

Zeta G200x helmet has LED work lights that are powered by a rechargeable Li-ion battery unit on the neckband.

1. Press the battery test button on the battery unit to check the battery level.
2. For charging, remove the battery unit from the helmet and charge the battery using the unit's USB-C connection and charging cable (charger not delivered with the product).
3. Insert the battery unit into the battery holder in the headband and connect the LED work light cable to it.
4. Use the OFF/AUTO/ON selector to turn the lights on and off. The AUTO mode turns the lights off in bright conditions (e.g. day light) and then back on.



Caution: Never use a damaged battery unit.

The LED light battery unit is not waterproof. Avoid exposure to extreme temperatures, direct sunlight, moisture, sand and dust.

Observe the battery unit while charging. If the battery unit becomes hot, smokes or there are visible deformations in the battery unit during charging, stop charging immediately.

5. Replacing parts

5.1 Removing headband 1

1. Press and hold down the distance slide adjuster (7).
2. Push the headband connector forwards, out of the distance slide adjuster.

5.2 Attaching headband 1

1. Bring the headband connector in front of the distance slide adjuster (7).
2. Press down the slide adjuster button while pushing the headband connector through the distance slide adjuster.
3. Slide the headband connector in place so that the slide adjuster pin locks into one of the grooves in the headband connector.
4. Adjust the helmet distance from your face.

5.3 Replacing grinding visor 3

1. To remove the grinding visor: Release the helmet fasteners by pulling the locking clips inwards and pull out the grinding visor (a).
2. To install the grinding visor: Place the visor clips into the helmet fasteners (b) and lock the helmet fasteners by pressing them upwards (c). Ensure that also the lower fasteners snap into place properly (d).

6. Maintenance

Inspect the helmet after each use. Replace worn or damaged parts.

6.1 Cleaning

- Clean the grinding visor with mild soap, lukewarm water and a soft cloth.
- Detach and wash the sweatband, if necessary.

7. Storage

Store the Zeta helmet in an environment with temperature between -20...+50 °C and humidity < 80 % Rh.

Store and transport the helmet and the accessories in the original bag or package.

8. Technical data

Grinding helmet	Zeta G200/G200x
Compliant with standards:	Regulation 2016/425 EN 166:2002-04, Personal eye protection, specifications AS/NZS 1337.1:2010
Type inspected by:	ECS GmbH, Hüttfeldstraße 50, 73430 Aalen, Germany. Notified Body No. 1883. SAI Global Certification Services Pty Limited, 680 George Street, Sydney NSW 2000, GPO Box 5420 Sydney NSW 2001, Australia. CCQS UK Ltd, 25 Wilton Rd, Pimlico, London SW1V 1LW, UK. Notified Body No. 1105.
Manufacturer:	Kemppi Oy PL 13, Kempinkatu 1, 15801 Lahti, Finland
Operating temperature:	-5°...+55 °C
Recommended humidity for use:	< 80 % Rh
Storage temperature:	-20...+50 °C
Materials:	Plastics: PA, PP, PC, ABS, POM Sweatband material 100 % cotton, padding foam plastic
Weight:	Zeta G200: 345 g, Zeta G200x: 485 g

LED work light	Zeta G200x only
Battery cell type:	Li-ion 3.65 V, 4 Ah, 14.6 Wh, rechargeable
Charging connector type:	USB-C
Battery life:	8 hours
Battery charging temperature:	0...+45 °C

9. Helmet and ocular markings

KMP	Identification of the manufacturer
1	Optical class
B	Symbol for mechanical strength
CE	CE marking (European Conformity)
UKCA	UKCA marking (UK Conformity)
EN 166	Standard reference

10. Ordering codes

Part	Ordering code
Headband	SP009023
Sweatband 2 pcs	SP9873018
Comfort band padding 5 pcs	SP013231
Grinding visor, clear 5 pcs	SP022580
Tear-off film, 10 pcs	SP024085

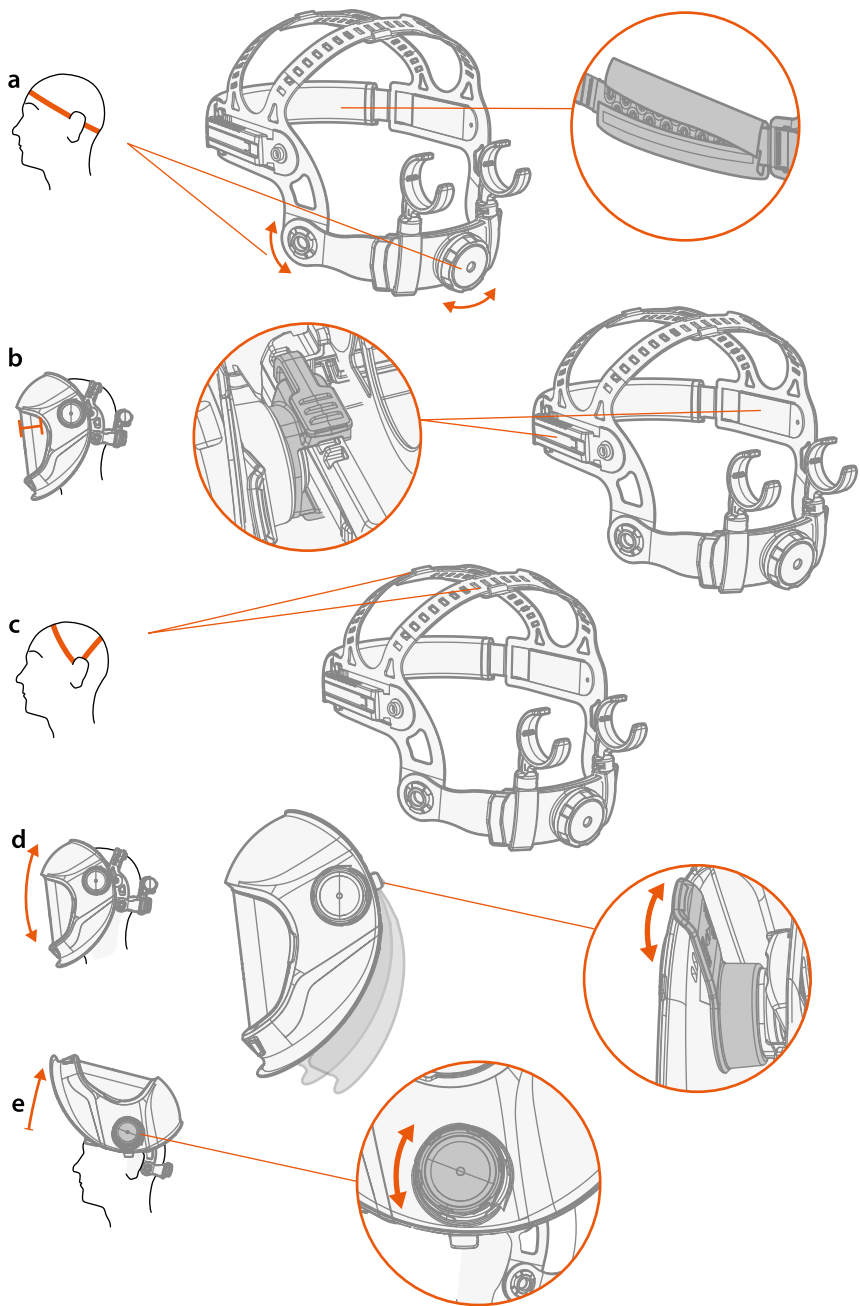

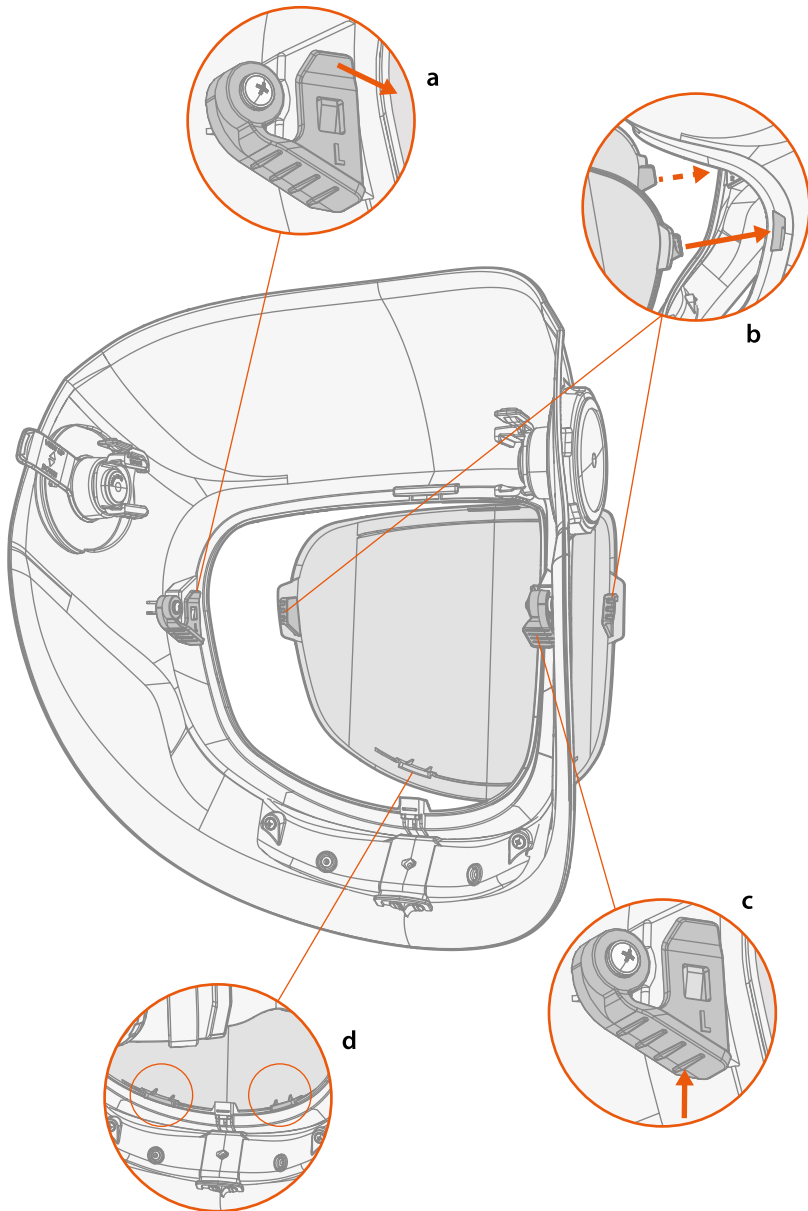

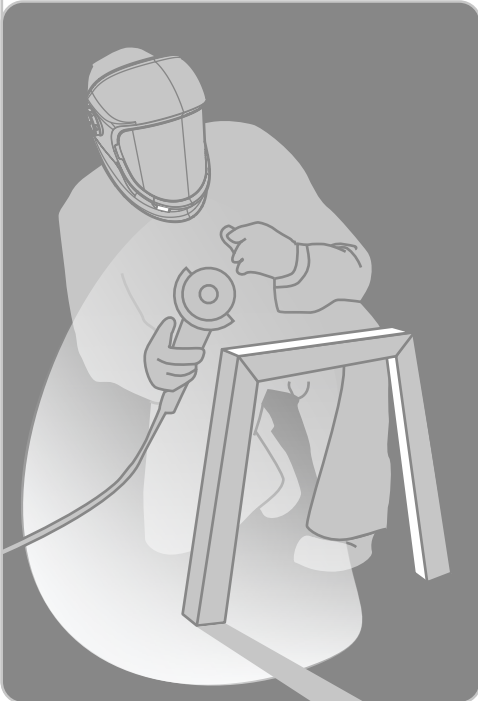
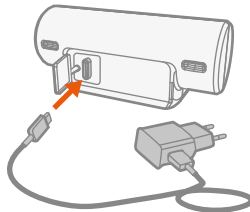
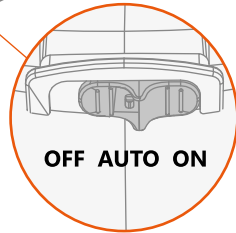
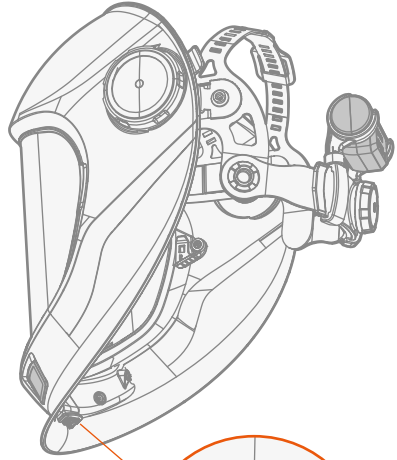
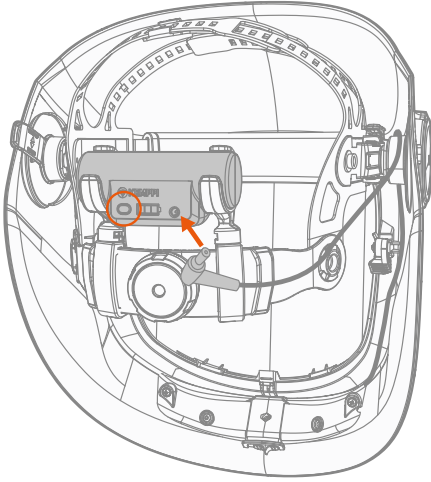



AS/NZS 1337.1
LIC 40174



Declarations of Conformity – Overensstemmelseerklæringer –
Konformitätserklärungen – Declaraciones de conformidad –
Vaatimustenmukaisuusvakuutuksia – Déclarations de conformité –
Dichiarazioni di conformità – Verklaringen van overeenstemming
– Samsvarserklæringer – Deklaracje zgodności – Declarações
de conformidade – Заявления о соответствии – Försäkran om
överensstämmelse – 符合性声明



userdoc.kemppi.com

