

**iWave 190i AC/DC**  
**iWave 230i AC/DC**  
**iWave 230i DC**

EN

Operating instructions

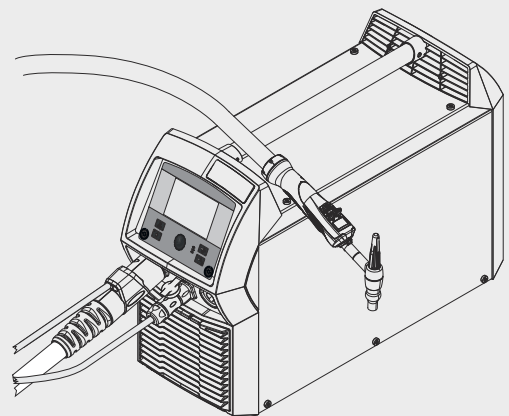

42,0426,0250,EN 013-17012022



# Contents

Safety rules.....	8
Explanation of safety notices.....	8
General.....	8
Proper use.....	9
Environmental conditions.....	9
Obligations of the operator.....	9
Obligations of personnel.....	9
Mains connection.....	10
Protecting yourself and others.....	10
Danger from toxic gases and vapours.....	10
Danger from flying sparks.....	11
Risks from mains current and welding current.....	11
Meandering welding currents.....	12
EMC Device Classifications.....	13
EMC measures.....	13
EMF measures.....	14
Specific hazards.....	14
Requirement for the shielding gas.....	15
Danger from shielding gas cylinders.....	15
Danger from escaping shielding gas.....	16
Safety measures at the installation location and during transport.....	16
Safety measures in normal operation.....	16
Noise emission values.....	17
Commissioning, maintenance and repair.....	17
Safety inspection.....	17
Disposal.....	18
Safety symbols.....	18
Data protection.....	18
Copyright.....	18
<b>General information.....</b>	<b>19</b>
General.....	21
Device concept.....	21
Functional principle.....	21
Application areas.....	21
Conformities.....	22
Bluetooth trademarks.....	22
Warning notices on the device.....	22
System components.....	24
General.....	24
Overview.....	24
Options.....	24
<b>Control elements and connections.....</b>	<b>25</b>
Control panel.....	27
General.....	27
Safety.....	27
Control panel.....	27
The favourites button.....	29
Assigning the Favourites button.....	29
Retrieving favourites.....	29
Deleting favourites.....	30
Assigning EasyJobs to the Favourites button.....	30
Connections, switches and mechanical components.....	32
Connections, switches and mechanical components.....	32
<b>Installation and commissioning.....</b>	<b>35</b>
Minimum equipment needed for welding task.....	37

General.....	37
TIG AC welding.....	37
TIG DC welding.....	37
MMA welding.....	37
Before installation and commissioning.....	38
Safety.....	38
Utilisation for intended purpose.....	38
Setup regulations.....	38
Mains connection.....	38
Generator-powered operation.....	39
Connecting the mains cable.....	40
General.....	40
Safety.....	40
Connecting the mains cable.....	40
Start-up.....	41
Safety.....	41
Remarks on the cooling unit.....	41
General.....	41
Fitting the system components.....	41
Connecting the gas cylinder.....	42
Connecting the welding torch to the power source and the cooling unit.....	42
Establishing a ground earth connection to the workpiece.....	43
Locking and unlocking the power source using the NFC key.....	44
General.....	44
Limitations.....	44
Locking and unlocking the power source using the NFC key.....	44

## **Welding**

**45**

TIG modes.....	47
Safety.....	47
Symbols and their explanations.....	47
2-step mode.....	48
4-step mode.....	48
Special 4-step mode: Variant 1.....	49
Special 4-step mode: Variant 2.....	50
Special 4-step mode: Variant 3.....	51
Special 4-step mode: Variant 4.....	52
Special 4-step mode: Variant 5.....	53
Special 4-step mode: Variant 6.....	54
Spot welding.....	55
CycleTIG.....	56
TIG welding.....	57
Safety.....	57
Preparation.....	57
TIG welding.....	58
Welding parameters for TIG DC welding.....	59
CycleTIG welding parameters.....	62
Welding parameters for TIG AC welding.....	63
Igniting the arc.....	68
General.....	68
Igniting the arc using high frequency(HF ignition).....	68
Touchdown ignition.....	69
Electrode overload.....	70
End of welding.....	70
TIG special functions.....	71
Ignition timeout function.....	71
TIG pulsing.....	71
Tacking function.....	72
CycleTIG.....	73
Manual metal arc welding, CEL welding.....	74
Safety.....	74

Preparation.....	74
Manual metal arc welding, CEL welding.....	75
Welding parameters for manual metal arc welding.....	76
Welding parameters for MMA welding with cellulose electrodes.....	77
Starting current > 100 % (HotStart).....	80
Starting current < 100 % (SoftStart).....	80
Anti-stick function.....	81
EasyJob mode.....	82
Storing EasyJob operating points.....	82
Retrieving EasyJob operating points.....	83
Deleting EasyJob operating points.....	83
Welding job.....	84
Safety.....	84
Preparation.....	84
Welding a job.....	85
<b>Setup settings</b> .....	<b>87</b>
The Setup menu.....	89
General.....	89
Accessing the Setup menu.....	89
Overview.....	90
Changing menus and parameters.....	91
The TIG menu.....	93
Parameters in the TIG DC menu.....	93
Parameters in the TIG AC menu.....	96
The MMA menu.....	100
Parameters in the rod electrode menu.....	100
The CEL menu.....	103
Parameters in the CEL menu.....	103
Ignition and mode settings.....	104
Ignition parameters.....	104
Arc monitoring.....	105
Operating mode defaults.....	106
The gas menu.....	108
Parameters in the Gas menu.....	108
The components menu.....	109
Parameters in the Components menu.....	109
Emptying the torch hosepack.....	110
Filling the torch hosepack.....	111
The documentation menu.....	113
The documentation menu.....	113
The Job menu.....	115
Saving a job.....	115
Saving a job via the Job menu.....	115
Saving a job using the adjusting dial.....	115
Loading a job.....	116
Deleting a job.....	117
Optimising job process parameters.....	117
Defaults for "Save job".....	120
EasyJobs on Favourites button.....	121
Defaults.....	122
Overview.....	122
Display.....	123
Backlighting.....	123
Languages.....	123
Time & Date.....	123
Show system data.....	124
Display additional parameters.....	125
iJob parameter display.....	126
System.....	127
Power source configurations.....	127

Reset to factory settings .....	127
Reset website password.....	127
Torch trigger I2 - cap mode.....	127
Performing R/L alignment.....	128
Network settings.....	130
General.....	130
Bluetooth on.....	130
Configuring Bluetooth devices .....	131
Network setup.....	131
Activating WLAN.....	132
WLAN settings.....	132
User management.....	133
Overview.....	133
General.....	134
General remarks.....	134
Explanation of terms .....	134
Pre-defined roles and users .....	134
Recommendation for creating roles and users.....	135
Create users and roles.....	136
Creating a user .....	136
Creating roles.....	136
Edit user / roles, deactivate user administration.....	138
Editing users .....	138
Editing roles .....	138
Deactivating user management .....	138
CENTRUM - Central User Management.....	139
Activating the CENTRUM server .....	139
Management.....	140
Trial license .....	140
Activating the trial license .....	140
System informations.....	141
Device information.....	141

**SmartManager - The power source website 143**

SmartManager - The power source website.....	145
General.....	145
Calling up the power source SmartManager .....	145
Fronius.....	145
Changing password / logging off.....	145
Language .....	146
Current system data.....	147
Current system data.....	147
Documentation, logbook.....	148
Logbook.....	148
Basic settings.....	149
Job-Data.....	150
Job data.....	150
Job overview .....	150
Editing a job .....	150
Importing a job.....	151
Exporting a job.....	151
Exporting job(s) as.....	151
Backup & Restore.....	152
General.....	152
Backup & Restore.....	152
User management.....	153
General.....	153
Users .....	153
User roles.....	153
Export & import.....	154
CENTRUM .....	154

Overview.....	155
Overview.....	155
Expanding / reducing all groups.....	155
Export component overview as .....	155
Update.....	156
Update.....	156
Function Packages.....	157
Function packages.....	157
Installing a function package.....	157
Screenshot.....	158
Screenshot.....	158
<b>Troubleshooting and maintenance</b> .....	<b>159</b>
Troubleshooting.....	161
General.....	161
Safety.....	161
Power source - troubleshooting.....	161
Care, maintenance and disposal .....	164
General.....	164
Safety.....	164
At every start-up.....	164
Every 2 months.....	164
Every 6 months.....	165
Disposal.....	165
<b>Appendix</b> .....	<b>167</b>
Average consumption values during welding.....	169
Average shielding gas consumption during TIG welding.....	169
Technical data.....	170
Overview with critical raw materials, year of production of the device.....	170
Special voltages.....	170
Versions of the appliance.....	170
iWave 190i AC/DC.....	170
iWave 190i AC/DC /MV.....	172
iWave 230i AC/DC.....	174
iWave 230i AC/DC /MV.....	175
iWave 230i DC.....	177
iWave 230i DC /MV.....	179
Explanation of footnotes.....	180
Radio parameters.....	181

# Safety rules

---

## Explanation of safety notices

### **DANGER!**

Indicates **immediate danger**.

- ▶ If not avoided, death or serious injury will result.
- 

### **WARNING!**

Indicates a **potentially hazardous situation**.

- ▶ If not avoided, death or serious injury may result.
- 

### **CAUTION!**

Indicates a **situation where damage or injury could occur**.

- ▶ If not avoided, minor injury and/or damage to property may result.
- 

### **NOTE!**

Indicates a **risk of flawed results and possible damage to the equipment**.

---

## General

The device is manufactured using state-of-the-art technology and according to recognised safety standards. If used incorrectly or misused, however, it can cause:

- injury or death to the operator or a third party,
  - damage to the device and other material assets belonging to the operating company,
  - inefficient operation of the device.
- 

All persons involved in commissioning, operating, maintaining and servicing the device must:

- be suitably qualified,
  - have sufficient knowledge of automated welding, and
  - read and carefully follow these operating instructions as well as the operating instructions for all system components.
- 

The operating instructions must always be at hand wherever the device is being used. In addition to the operating instructions, attention must also be paid to any generally applicable and local regulations regarding accident prevention and environmental protection.

---

All safety and danger notices on the device

- must be in a legible state,
  - must not be damaged,
  - must not be removed,
  - must not be covered, pasted or painted over.
- 

For the location of the safety and danger notices on the device, refer to the section headed "General" in the operating instructions for the device.

Before commissioning the device, rectify any faults that could compromise safety.

**This is for your personal safety!**



<b>Proper use</b>	The device is to be used exclusively for its intended purpose.
	The device is intended solely for the welding processes specified on the rating plate. Any use above and beyond this purpose is deemed improper. The manufacturer shall not be held liable for any damage arising from such usage.
	Proper use includes: <ul style="list-style-type: none"> <li>- carefully reading and following all the instructions given in the operating instructions</li> <li>- studying and obeying all safety and danger notices carefully</li> <li>- performing all stipulated inspection and maintenance work.</li> </ul>
	Never use the device for the following purposes: <ul style="list-style-type: none"> <li>- Thawing out pipes</li> <li>- Charging batteries</li> <li>- Starting engines</li> </ul>
	The device is designed for use in industry and the workshop. The manufacturer accepts no responsibility for any damage caused through use in a domestic setting.
	The manufacturer likewise accepts no liability for inadequate or incorrect results.

<b>Environmental conditions</b>	Operation or storage of the device outside the stipulated area will be deemed as not in accordance with the intended purpose. The manufacturer shall not be held liable for any damage arising from such usage.
	Ambient temperature range: <ul style="list-style-type: none"> <li>- during operation: -10 °C to + 40 °C (14 °F to 104 °F)</li> <li>- during transport and storage: -20 °C to +55 °C (-4 °F to 131 °F)</li> </ul>
	Relative humidity: <ul style="list-style-type: none"> <li>- up to 50% at 40 °C (104 °F)</li> <li>- up to 90% at 20 °C (68 °F)</li> </ul>
	The surrounding air must be free from dust, acids, corrosive gases or substances, etc. Can be used at altitudes of up to 2000 m (6561 ft. 8.16 in.)

<b>Obligations of the operator</b>	The operator must only allow persons to work with the device who: <ul style="list-style-type: none"> <li>- are familiar with the fundamental instructions regarding safety at work and accident prevention and have been instructed in how to use the device</li> <li>- have read and understood these operating instructions, especially the section "safety rules", and have confirmed as much with their signatures</li> <li>- are trained to produce the required results.</li> </ul>
	Checks must be carried out at regular intervals to ensure that operators are working in a safety-conscious manner.

<b>Obligations of personnel</b>	Before using the device, all persons instructed to do so undertake: <ul style="list-style-type: none"> <li>- to observe the basic instructions regarding safety at work and accident prevention</li> <li>- to read these operating instructions, especially the "Safety rules" section and sign to confirm that they have understood them and will follow them.</li> </ul>
	Before leaving the workplace, ensure that people or property cannot come to any harm in your absence.

---

**Mains connection** Devices with a higher rating may affect the energy quality of the mains due to their current consumption.

---

This may affect a number device types in terms of:

- Connection restrictions
- Criteria with regard to the maximum permissible mains impedance <sup>\*)</sup>
- Criteria with regard to the minimum short-circuit power requirement <sup>\*)</sup>

<sup>\*)</sup> at the interface with the public grid  
see "Technical data"

---

In this case, the plant operator or the person using the device should check whether the device may be connected, where appropriate by discussing the matter with the power supply company.

---

**IMPORTANT!** Ensure that the mains connection is earthed properly

---

---

**Protecting yourself and others**

Anyone working with the device exposes themselves to numerous risks, e.g.

- flying sparks and hot pieces of metal
  - Arc radiation, which can damage eyes and skin
  - Hazardous electromagnetic fields, which can endanger the lives of those using cardiac pacemakers
  - Risk of electrocution from mains current and welding current
  - Greater noise pollution
  - Harmful welding fumes and gases
- 

Suitable protective clothing must be worn when working with the device. The protective clothing must have the following properties:

- Flame-resistant
  - Insulating and dry
  - Covers the whole body, is undamaged and in good condition
  - Safety helmet
  - Trousers with no turn-ups
- 

Protective clothing refers to a variety of different items. Operators should:

- Protect eyes and face from UV rays, heat and sparks using a protective visor and regulation filter
  - Wear regulation protective goggles with side protection behind the protective visor
  - Wear stout footwear that provides insulation even in wet conditions
  - Protect the hands with suitable gloves (electrically insulated and providing protection against heat)
  - Wear ear protection to reduce the harmful effects of noise and to prevent injury
- 

Keep all persons, especially children, out of the working area while any devices are in operation or welding is in progress. If, however, there are people in the vicinity:

- Make them aware of all the dangers (risk of dazzling by the arc, injury from flying sparks, harmful welding fumes, noise, possible risks from mains current and welding current, etc.)
  - Provide suitable protective equipment
  - Alternatively, erect suitable safety screens/curtains.
- 

---

**Danger from toxic gases and vapours**

The fumes produced during welding contain harmful gases and vapours.

---

Welding fumes contain substances that cause cancer, as stated in Monograph 118 of the International Agency for Research on Cancer.

---

Use at-source extraction and a room extraction system.  
If necessary, use a welding torch with an integrated extraction device.

---

Keep your face away from welding fumes and gases.

---

Fumes and hazardous gases

- must not be breathed in
  - must be extracted from the working area using appropriate methods.
- 

Ensure an adequate supply of fresh air. Ensure that there is a ventilation rate of at least 20 m<sup>3</sup> per hour at all times.

---

Otherwise, a welding helmet with an air supply must be worn.

---

If there is any doubt about whether the extraction capacity is sufficient, the measured toxic emission values should be compared with the permissible limit values.

---

The following components are responsible, amongst other things, for the degree of toxicity of welding fumes:

- Metals used for the workpiece
  - Electrodes
  - Coatings
  - Cleaners, degreasers, etc.
  - Welding process used
- 

The relevant material safety data sheets and manufacturer's specifications for the listed components should therefore be studied carefully.

---

Recommendations for trade fair scenarios, risk management measures and for identifying working conditions can be found on the European Welding Association website under Health & Safety (<https://european-welding.org>).

---

Flammable vapours (e.g. solvent fumes) should be kept away from the arc's radiation area.

---

Close the shielding gas cylinder valve or main gas supply if no welding is taking place.

---

### **Danger from flying sparks**

Flying sparks may cause fires or explosions.

---

Never weld close to flammable materials.

---

Flammable materials must be at least 11 metres (36 ft. 1.07 in.) away from the arc, or alternatively covered with an approved cover.

---

A suitable, tested fire extinguisher must be available and ready for use.

---

Sparks and pieces of hot metal may also get into adjacent areas through small gaps or openings. Take appropriate precautions to prevent any danger of injury or fire.

---

Welding must not be performed in areas that are subject to fire or explosion or near sealed tanks, vessels or pipes unless these have been prepared in accordance with the relevant national and international standards.

---

Do not carry out welding on containers that are being or have been used to store gases, propellants, mineral oils or similar products. Residues pose an explosive hazard.

---

### **Risks from mains current and welding current**

An electric shock is potentially life threatening and can be fatal.

---

Do not touch live parts either inside or outside the device.

---

During MIG/MAG welding and TIG welding, the welding wire, the wirespool, the feed rollers and all pieces of metal that are in contact with the welding wire are live.

---

Always set the wirefeeder up on a sufficiently insulated surface or use a suitable, insulated wirefeeder holder.

---

Make sure that you and others are protected with an adequately insulated, dry base or cover for the earth or ground potential. This base or cover must extend over the entire area between the body and the earth or ground potential.

---

All cables and leads must be secured, undamaged, insulated and adequately dimensioned. Replace loose connections and scorched, damaged, or inadequately dimensioned cables and leads immediately.

Use the handle to ensure the power connections are tight before every use.

In the case of power cables with a bayonet connector, rotate the power cable around the longitudinal axis by at least 180° and pretension.

---

Do not wrap cables or leads around the body or parts of the body.

---

The electrode (rod electrode, tungsten electrode, welding wire, etc.) must

- never be immersed in liquid for cooling
  - Never touch the electrode when the power source is switched on.
- 

Double the open circuit voltage of a power source can occur between the welding electrodes of two power sources. Touching the potentials of both electrodes at the same time may be fatal under certain circumstances.

---

Arrange for the mains cable to be checked regularly by a qualified electrician to ensure the ground conductor is functioning properly.

---

Protection class I devices require a mains supply with ground conductor and a connector system with ground conductor contact for proper operation.

---

Operation of the device on a mains supply without ground conductor and on a socket without ground conductor contact is only permitted if all national regulations for protective separation are observed.

Otherwise, this is considered gross negligence. The manufacturer shall not be held liable for any damage arising from such usage.

---

If necessary, provide adequate earthing for the workpiece.

---

Switch off unused devices.

---

Wear a safety harness if working at height.

---

Before working on the device, switch it off and pull out the mains plug.

---

Attach a clearly legible and easy-to-understand warning sign to the device to prevent anyone from plugging the mains plug back in and switching it on again.

---

After opening the device:

- Discharge all live components
  - Ensure that all components in the device are de-energised.
- 

If work on live parts is required, appoint a second person to switch off the main switch at the right moment.

---

---

### **Meandering welding currents**

If the following instructions are ignored, meandering welding currents can develop with the following consequences:

- Fire hazard
  - Overheating of parts connected to the workpiece
  - Damage to ground conductors
  - Damage to device and other electrical equipment
-

Ensure that the workpiece is held securely by the workpiece clamp.

---

Attach the workpiece clamp as close as possible to the area that is to be welded.

---

Position the device with sufficient insulation against electrically conductive environments, such as insulation against conductive floor or insulation to conductive racks.

---

If power distribution boards, twin-head mounts, etc., are being used, note the following: The electrode of the welding torch / electrode holder that is not used is also live. Make sure that the welding torch / electrode holder that is not used is kept sufficiently insulated.

---

### EMC Device Classifications

Devices in emission class A:

- Are only designed for use in industrial settings
  - Can cause line-bound and radiated interference in other areas
- 

Devices in emission class B:

- Satisfy the emissions criteria for residential and industrial areas. This is also true for residential areas in which the energy is supplied from the public low-voltage mains.
- 

EMC device classification as per the rating plate or technical data.

---

### EMC measures

In certain cases, even though a device complies with the standard limit values for emissions, it may affect the application area for which it was designed (e.g. when there is sensitive equipment at the same location, or if the site where the device is installed is close to either radio or television receivers).

If this is the case, then the operator is obliged to take appropriate action to rectify the situation.

---

Check and evaluate the immunity to interference of nearby devices according to national and international regulations. Examples of equipment that may be susceptible to interference from the device include:

- Safety devices
  - Network, signal and data transfer lines
  - IT and telecommunications devices
  - Measuring and calibrating devices
- 

Supporting measures for avoidance of EMC problems:

1. Mains supply
  - If electromagnetic interference arises despite the correct mains connection, additional measures are necessary (e.g. use of a suitable line filter)
2. Welding power-leads
  - must be kept as short as possible
  - must be laid close together (to avoid EMF problems)
  - must be kept well apart from other leads
3. Equipotential bonding
4. Earthing of the workpiece
  - If necessary, establish an earth connection using suitable capacitors.
5. Shield, if necessary
  - Shield other devices nearby
  - Shield the entire welding installation

---

**EMF measures**

Electromagnetic fields may pose as yet unknown risks to health:

- Effects on the health of persons in the vicinity, e.g. those with pacemakers and hearing aids
  - Individuals with pacemakers must seek advice from their doctor before approaching the device or any welding that is in progress
  - For safety reasons, maintain as large a distance as possible between the welding power-leads and the head/torso of the welder
  - Do not carry welding power-leads and hosepacks over the shoulders or wind them around any part of the body
- 

**Specific hazards**

Keep hands, hair, clothing and tools away from moving parts. For example:

- Fans
  - Cogs
  - Rollers
  - Shafts
  - Wirespools and welding wires
- 

Do not reach into the rotating cogs of the wire drive or into rotating drive components.

---

Covers and side panels may only be opened/removed while maintenance or repair work is being carried out.

---

During operation

- Ensure that all covers are closed and all side panels are fitted properly.
  - Keep all covers and side panels closed.
- 

The welding wire emerging from the welding torch poses a high risk of injury (piercing of the hand, injuries to the face and eyes, etc.).

---

Therefore, always keep the welding torch away from the body (devices with wirefeeder) and wear suitable protective goggles.

---

Never touch the workpiece during or after welding - risk of burns.

---

Slag can jump off cooling workpieces. The specified protective equipment must therefore also be worn when reworking workpieces, and steps must be taken to ensure that other people are also adequately protected.

---

Welding torches and other parts with a high operating temperature must be allowed to cool down before handling.

---

Special provisions apply in areas at risk of fire or explosion

- observe relevant national and international regulations.
- 

Power sources for work in areas with increased electric risk (e.g. near boilers) must carry the "Safety" sign. However, the power source must not be located in such areas.

---

Risk of scalding from escaping coolant. Switch off cooling unit before disconnecting coolant flow or return lines.

---

Observe the information on the coolant safety data sheet when handling coolant. The coolant safety data sheet may be obtained from your service centre or downloaded from the manufacturer's website.

---

Use only suitable load-carrying equipment supplied by the manufacturer when transporting devices by crane.

- Hook chains or ropes onto all suspension points provided on the load-carrying equipment.
  - Chains and ropes must be at the smallest angle possible to the vertical.
  - Remove gas cylinder and wirefeeder (MIG/MAG and TIG devices).
-

If the wirefeeder is attached to a crane holder during welding, always use a suitable, insulated wirefeeder hoisting attachment (MIG/MAG and TIG devices).

If the device has a carrying strap or handle, this is intended solely for carrying by hand. The carrying strap is not to be used if transporting with a crane, counterbalanced lift truck or other mechanical hoist.

All lifting tackle (straps, handles, chains, etc.) used in connection with the device or its components must be tested regularly (e.g. for mechanical damage, corrosion or changes caused by other environmental factors).

The testing interval and scope of testing must comply with applicable national standards and directives as a minimum.

Odourless and colourless shielding gas may escape unnoticed if an adapter is used for the shielding gas connection. Prior to assembly, seal the device-side thread of the adapter for the shielding gas connection using suitable Teflon tape.

### **Requirement for the shielding gas**

Especially with ring lines, contaminated shielding gas can cause damage to equipment and reduce welding quality.

Meet the following requirements regarding shielding gas quality:

- Solid particle size < 40 µm
- Pressure condensation point < -20 °C
- Max. oil content < 25 mg/m<sup>3</sup>

Use filters if necessary.

### **Danger from shielding gas cylinders**

Shielding gas cylinders contain gas under pressure and can explode if damaged. As the shielding gas cylinders are part of the welding equipment, they must be handled with the greatest of care.

Protect shielding gas cylinders containing compressed gas from excessive heat, mechanical impact, slag, naked flames, sparks and arcs.

Mount the shielding gas cylinders vertically and secure according to instructions to prevent them falling over.

Keep the shielding gas cylinders well away from any welding or other electrical circuits.

Never hang a welding torch on a shielding gas cylinder.

Never touch a shielding gas cylinder with an electrode.

Risk of explosion - never attempt to weld a pressurised shielding gas cylinder.

Only use shielding gas cylinders suitable for the application in hand, along with the correct and appropriate accessories (regulator, hoses and fittings). Only use shielding gas cylinders and accessories that are in good condition.

Turn your face to one side when opening the valve of a shielding gas cylinder.

Close the shielding gas cylinder valve if no welding is taking place.

If the shielding gas cylinder is not connected, leave the valve cap in place on the cylinder.

The manufacturer's instructions must be observed as well as applicable national and international regulations for shielding gas cylinders and accessories.

---

**Danger from escaping shielding gas**

Risk of suffocation from the uncontrolled escape of shielding gas

---

Shielding gas is colourless and odourless and, in the event of a leak, can displace the oxygen in the ambient air.

- Ensure an adequate supply of fresh air with a ventilation rate of at least 20 m<sup>3</sup>/hour.
  - Observe safety and maintenance instructions on the shielding gas cylinder or the main gas supply.
  - Close the shielding gas cylinder valve or main gas supply if no welding is taking place.
  - Check the shielding gas cylinder or main gas supply for uncontrolled gas leakage before every start-up.
- 

**Safety measures at the installation location and during transport**

A device toppling over could easily kill someone. Place the device on a solid, level surface such that it remains stable

- The maximum permissible tilt angle is 10°.
- 

Special regulations apply in rooms at risk of fire or explosion

- Observe relevant national and international regulations.
- 

Use internal directives and checks to ensure that the workplace environment is always clean and clearly laid out.

---

Only set up and operate the device in accordance with the degree of protection shown on the rating plate.

---

When setting up the device, ensure there is an all-round clearance of 0.5 m (1 ft. 7.69 in.) to ensure that cooling air can flow in and out freely.

---

When transporting the device, observe the relevant national and local guidelines and accident prevention regulations. This applies especially to guidelines regarding the risks arising during transport.

---

Do not lift or transport operational devices. Switch off devices before transport or lifting.

---

Before transporting the device, allow coolant to drain completely and detach the following components:

- Wirefeeder
  - Wirespool
  - Shielding gas cylinder
- 

After transporting the device, the device must be visually inspected for damage before commissioning. Any damage must be repaired by trained service technicians before commissioning the device.

---

---

**Safety measures in normal operation**

Only operate the device when all safety devices are fully functional. If the safety devices are not fully functional, there is a risk of

- injury or death to the operator or a third party
  - damage to the device and other material assets belonging to the operator
  - inefficient operation of the device
- 

Any safety devices that are not functioning properly must be repaired before switching on the device.

---

Never bypass or disable safety devices.

---

Before switching on the device, ensure that no one is likely to be endangered.

---

Check the device at least once a week for obvious damage and proper functioning of safety devices.

---



---

Always fasten the shielding gas cylinder securely and remove it beforehand if the device is to be transported by crane.

---

Only the manufacturer's original coolant is suitable for use with our devices due to its properties (electrical conductivity, anti-freeze agent, material compatibility, flammability, etc.).

---

Only use suitable original coolant from the manufacturer.

---

Do not mix the manufacturer's original coolant with other coolants.

---

Only connect the manufacturer's system components to the cooling circuit.

---

The manufacturer accepts no liability for damage resulting from use of other system components or a different coolant. In addition, all warranty claims will be forfeited.

---

Cooling Liquid FCL 10/20 does not ignite. The ethanol-based coolant can ignite under certain conditions. Transport the coolant only in its original, sealed containers and keep well away from any sources of ignition.

---

Used coolant must be disposed of properly in accordance with the relevant national and international regulations. The coolant safety data sheet may be obtained from your service centre or downloaded from the manufacturer's website.

---

Check the coolant level before starting to weld, while the system is still cool.

---

#### Noise emission values

The device generates a maximum sound power level of > 80 dB(A) (ref. 1pW) when idling and in the cooling phase following operation at the maximum permissible operating point under maximum rated load conditions according to EN 60974-1.

---

It is not possible to provide a workplace-related emission value during welding (or cutting) as this is influenced by both the process and the environment. All manner of different welding parameters come into play, including the welding process (MIG/MAG, TIG welding), the type of power selected (DC or AC), the power range, the type of weld metal, the resonance characteristics of the workpiece, the workplace environment, etc.

---

#### Commissioning, maintenance and repair

It is impossible to guarantee that bought-in parts are designed and manufactured to meet the demands made of them, or that they satisfy safety requirements.

- Use only original spare and wearing parts (also applies to standard parts).
  - Do not carry out any modifications, alterations, etc. to the device without the manufacturer's consent.
  - Components that are not in perfect condition must be replaced immediately.
  - When ordering, please give the exact designation and part number as shown in the spare parts list, as well as the serial number of your device.
- 

The housing screws provide the ground conductor connection for earthing the housing parts.

Only use original housing screws in the correct number and tightened to the specified torque.

---

#### Safety inspection

The manufacturer recommends that a safety inspection of the device is performed at least once every 12 months.

---

The manufacturer recommends that the power source be calibrated during the same 12-month period.

---

- A safety inspection should be carried out by a qualified electrician
- after any changes are made
  - after any additional parts are installed, or after any conversions
  - after repair, care and maintenance has been carried out
  - at least every twelve months.
- 

For safety inspections, follow the appropriate national and international standards and directives.

---

Further details on safety inspection and calibration can be obtained from your service centre. They will provide you on request with any documents you may require.

---

## **Disposal**

Do not dispose of this device with normal domestic waste! To comply with the European Directive on Waste Electrical and Electronic Equipment and its implementation as national law, electrical equipment that has reached the end of its life must be collected separately and returned to an approved recycling facility. Any device that you no longer require must either be returned to your dealer or given to one of the approved collection and recycling facilities in your area. Ignoring this European Directive may have potentially adverse affects on the environment and your health!

---

## **Safety symbols**

Devices with the CE mark satisfy the essential requirements of the low-voltage and electromagnetic compatibility directives (e.g. relevant product standards of the EN 60 974 series).

Fronius International GmbH hereby declares that the device is compliant with Directive 2014/53/EU. The full text on the EU Declaration of Conformity can be found at the following address: <http://www.fronius.com>

---

Devices marked with the CSA test mark satisfy the requirements of the relevant standards for Canada and the USA.

---

## **Data protection**

The user is responsible for the safekeeping of any changes made to the factory settings. The manufacturer accepts no liability for any deleted personal settings.

---

## **Copyright**

Copyright of these operating instructions remains with the manufacturer.

---

The text and illustrations are all technically correct at the time of printing. We reserve the right to make changes. The contents of the operating instructions shall not provide the basis for any claims whatsoever on the part of the purchaser. If you have any suggestions for improvement, or can point out any mistakes that you have found in the instructions, we will be most grateful for your comments.

# **General information**



## Device concept

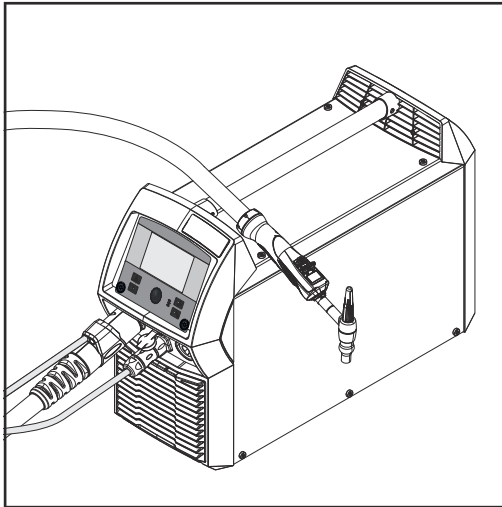

The iWave 230i DC, iWave 190i AC/DC and iWave 230i AC/DC TIG power sources are fully digitised, microprocessor-controlled inverter power sources.

Their modular design and potential for system add-ons ensure a high degree of flexibility. The devices can be adapted to any situation.

The power sources are generator-compatible. They are exceptionally sturdy in day-to-day operation thanks to the protected control elements and their powder-coated housings.

The iWave-Stromquellen sind mit der Funktion eines have a TIG pulsed arc function with a wide frequency range.

To optimise the ignition sequence in TIG AC welding, the iWave AC/DC takes into account not only the diameter of the electrode, but also its current temperature, calculated with reference to the preceding welding time and welding off-time.

## Functional principle

The central control and regulation unit of the power sources is coupled with a digital signal processor. The central control and regulation unit and signal processor control the entire welding process.

During the welding process, the actual data is measured continuously and the device responds immediately to any changes. Control algorithms ensure that the desired target state is maintained.

This results in:

- a precise welding process,
- exact reproducibility of all results
- excellent weld properties.

## Application areas

The devices are used in workshops and industry for manual TIG applications with unalloyed and low-alloy steel and high-alloy chrome-nickel steels.

The iWave AC/DC power sources perform exceptionally well when it comes to welding aluminium, aluminium alloys and magnesium due to the variable AC frequency.

---

**Conformities****FCC**

This equipment complies with the limit values for an EMC device class A digital device pursuant to Part 15 of the FCC Rules. These limit values are intended to provide an adequate level of protection against harmful emissions when the device is being used in an industrial environment. This device generates and uses high-frequency energy and can cause interference to radio communications if it is not installed and used according to the Operating Instructions.

The use of this device in residential areas will probably cause harmful interference, in which case the user will be obliged to correct the interference at their own expense.

FCC ID: QKWSPBBCU1

---

**Industry Canada RSS**

This device complies with the Industry Canada licence-exempt RSS standards. Its use is subject to the following conditions:

- (1) The device must not cause any harmful interference.
- (2) The device must be able to cope with any interference, including that which could adversely affect its operation.

IC: 12270A-SPBBCU1

---

**EU**

Conformity with Directive 2014/53 / EU - Radio Equipment Directive (RED)

When installing the antennae to be used for this transmitter, it is essential to maintain a minimum distance of 20 cm from all people. They must not be installed or operated with any other antenna or transmitter.

OEM integrators and end users must be aware of the operating conditions of the transmitter in order to comply with the radio frequency exposure guidelines.

---

**NOM / Mexico**

Operation of this device is subject to the following two conditions:

- (1) This device must not cause any harmful interference,  
and
  - (2) This device must accept any interference received, including interference that may cause undesired operation.
- 

**Bluetooth trademarks**

The Bluetooth® word mark and logos are registered trademarks owned by Bluetooth SIG, Inc. and any use of such marks by Fronius International GmbH is under license. Other trademarks and trade names are those of their respective owners.

---

**Warning notices on the device**

Warning notices and safety symbols are affixed to power sources with the CSA test mark for use in North America (USA and Canada). These warning notices and safety symbols must not be removed or painted over. They warn against incorrect operation, as this may result in serious injury and damage.

<b>⚠ WARNING</b>		<b>⚠ AVERTISSEMENT</b>	
<b>Do Not Remove, Destroy, or Cover This Label</b>		<b>Ne pas retirer, détruire ni couvrir cette étiquette</b>	
	<p><b>PROTECT yourself and others. ARC PROCESSES can be hazardous.</b></p> <ul style="list-style-type: none"> <li>• Before use, read and follow all labels, the manufacturer's instruction manual, employer's safety practices, and Material Safety Data Sheets (MSDSs)</li> <li>• Only qualified persons are to install, use, or service this equipment • Pacemaker wearers keep away</li> <li>• Damaged or modified batteries may exhibit unpredictable behaviour resulting in fire, explosion or risk of injury.</li> </ul>		<p><b>SE PROTÉGER et protéger les autres. Les PROCÉDÉS À L'ARC ÉLECTRIQUE peuvent être dangereux.</b></p> <ul style="list-style-type: none"> <li>• Avant utilisation, lire et respecter l'ensemble des étiquettes, les instructions de service du fabricant, les pratiques de sécurité de l'employeur et les fiches techniques de sécurité du matériau. • Seules des personnes qualifiées sont autorisées à installer, utiliser ou assurer l'entretien de cet équipement. • Les personnes portant un stimulateur cardiaque doivent rester à l'écart. • Les batteries endommagées ou modifiées peuvent avoir un comportement imprévisible susceptible de provoquer un incendie, une explosion ou un risque de blessure.</li> </ul>
	<p><b>ELECTRIC SHOCK can kill.</b></p> <ul style="list-style-type: none"> <li>• Do not touch live electrical parts. • Always wear dry insulating gloves. • Insulate yourself from work and ground. • Disconnect input power before servicing unit. • Welding wire and drive parts may be at welding voltage.</li> </ul>		<p><b>Les DÉCHARGES ÉLECTRIQUES peuvent être mortelles.</b></p> <ul style="list-style-type: none"> <li>• Ne pas toucher les composants électriques sous tension. • Toujours porter des gants isolants secs. • S'isoler de la zone de travail et de la terre. • Déconnecter l'alimentation d'entrée avant de procéder à l'entretien de l'unité. • Le fil d'apport et les composants d'entraînement peuvent être porteurs de la tension de soudage.</li> </ul>
	<p><b>FUMES AND GASES can be hazardous to your health.</b></p> <ul style="list-style-type: none"> <li>• Keep your head out of the fumes. • Use enough ventilation, exhaust at the arc, or both to keep fumes and gases from your breathing zone and the general area. • Under abusive conditions, liquid may be ejected from the battery; avoid contact.</li> </ul>		<p><b>Les FUMÉES ET GAZ peuvent être nocifs pour la santé.</b></p> <ul style="list-style-type: none"> <li>• Garder la tête à l'écart des fumées. • Utiliser une ventilation suffisante, un échappement au niveau de l'arc électrique, voire les deux pour maintenir les fumées et les gaz à l'écart de la zone de respiration et de la zone générale. • En cas d'utilisation abusive, du liquide peut être éjecté de la batterie; éviter tout contact.</li> </ul>
	<p><b>SPARKS AND SPATTER can cause fire or explosion.</b></p> <ul style="list-style-type: none"> <li>• Do not use near flammable material. • Do not use on closed containers.</li> </ul>		<p><b>La FORMATION DE PROJECTIONS ET D'ÉTINCELLES peut provoquer un incendie ou une explosion.</b></p> <ul style="list-style-type: none"> <li>• Ne pas utiliser à proximité d'un matériau inflammable. • Ne pas utiliser sur des contenants fermés.</li> </ul>
	<p><b>ARC RAYS can injure eyes and burn skin. NOISE can damage hearing.</b></p> <ul style="list-style-type: none"> <li>• Wear correct eye, ear, and body protection.</li> </ul>	<p><b>Les RAYONS D'ARC ÉLECTRIQUE peuvent provoquer des blessures oculaires et des brûlures. Le BRUIT peut endommager l'ouïe.</b></p> <ul style="list-style-type: none"> <li>• Porter une protection oculaire, auditive et corporelle adaptée.</li> </ul>	

See American National Standard Z49.1, "Safety in Welding, Cutting, and Allied Processes", download at [www.aws.org](http://www.aws.org) published by the American Welding Society, 550 NW LeJeune Road, Miami, FL 33126; OSHA Safety and Health Standards, 29 CFR 1910, download at [www.osha.gov](http://www.osha.gov) available from the U.S. Government Printing Office. CSA, W117.2 Code for Safety in welding, cutting, and allied processes 42.0409.5074

\* MV power sources: 1 ~ 100 - 230 V

Safety symbols on the rating plate:



Welding is dangerous. The following basic requirements must be met:

- Welders must be sufficiently qualified
- Suitable protective equipment must be used
- All persons not involved in the welding process must be kept at a safe distance



Do not use the functions described here until you have fully read and understood the following documents:

- These Operating Instructions
- All the Operating Instructions for the system components, especially the safety rules

# System components

---

## General

The iWave DC and iWave AC/DC power sources can be used with a wide variety of system add-ons and options.

---

## Overview

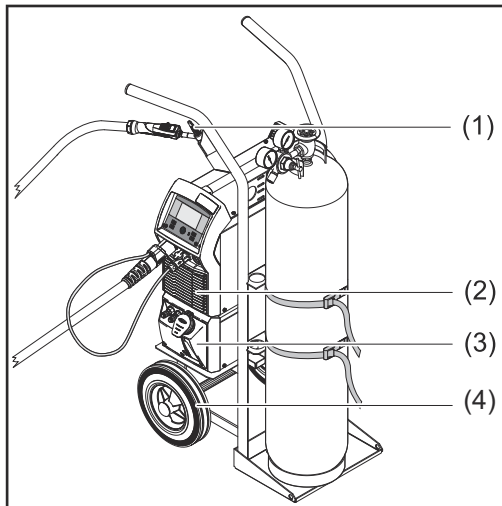

- (1) TIG welding torch
- (2) Power sources
- (3) Cooling units (only for iWave 230i DC and iWave 230i AC/DC)
- (4) Trolley with gas cylinder holder

Not illustrated:

- Remote controls
  - Pedal remote controls
  - Electrode cable
  - Grounding cable
- 

## Options

### **OPT/i Ethernet iWave 190i/230i**

Option for a permanent network connection

---

### **Carrying strap option**

---

### **OPT/i Pulse Pro**

Function package for the extended pulse function (the Base current and Duty cycle parameters can be set, extended pulse frequency range)

---

### **OPT/i Jobs**

Function package for Job mode (EasyJobs, save and edit jobs)

---

### **OPT/i Documentation**

Option for the documentation function

---

### **OPT/i Limit Monitoring**

Option for specifying the limit values for the welding current, welding voltage and wire speed

---

### **OPT/i CycleTIG**

Enhanced TIG stitch welding

---

### **OPT/i Custom NFC - ISO 14443A**

Option to use a customer-specific frequency band for key cards

---

### **OPT/i OPC-UA**

Standardised data interface protocol

---

### **OPT/i MQTT**

Standardised data interface protocol

---



# **Control elements and connections**



# Control panel

## General

### NOTE!

Due to software updates, you may find that your device has certain functions that are not described in these Operating Instructions or vice versa.

Certain illustrations may also differ slightly from the actual controls on your device, but these controls function in exactly the same way.

## Safety

### ⚠ WARNING!

**Danger from incorrect operation and work that is not carried out properly.**

This can result in serious personal injury and damage to property.

- ▶ All the work and functions described in this document must only be carried out by technically trained and qualified personnel.
- ▶ Read and understand this document in full.
- ▶ Read and understand all safety rules and user documentation for this device and all system components.

## Control panel

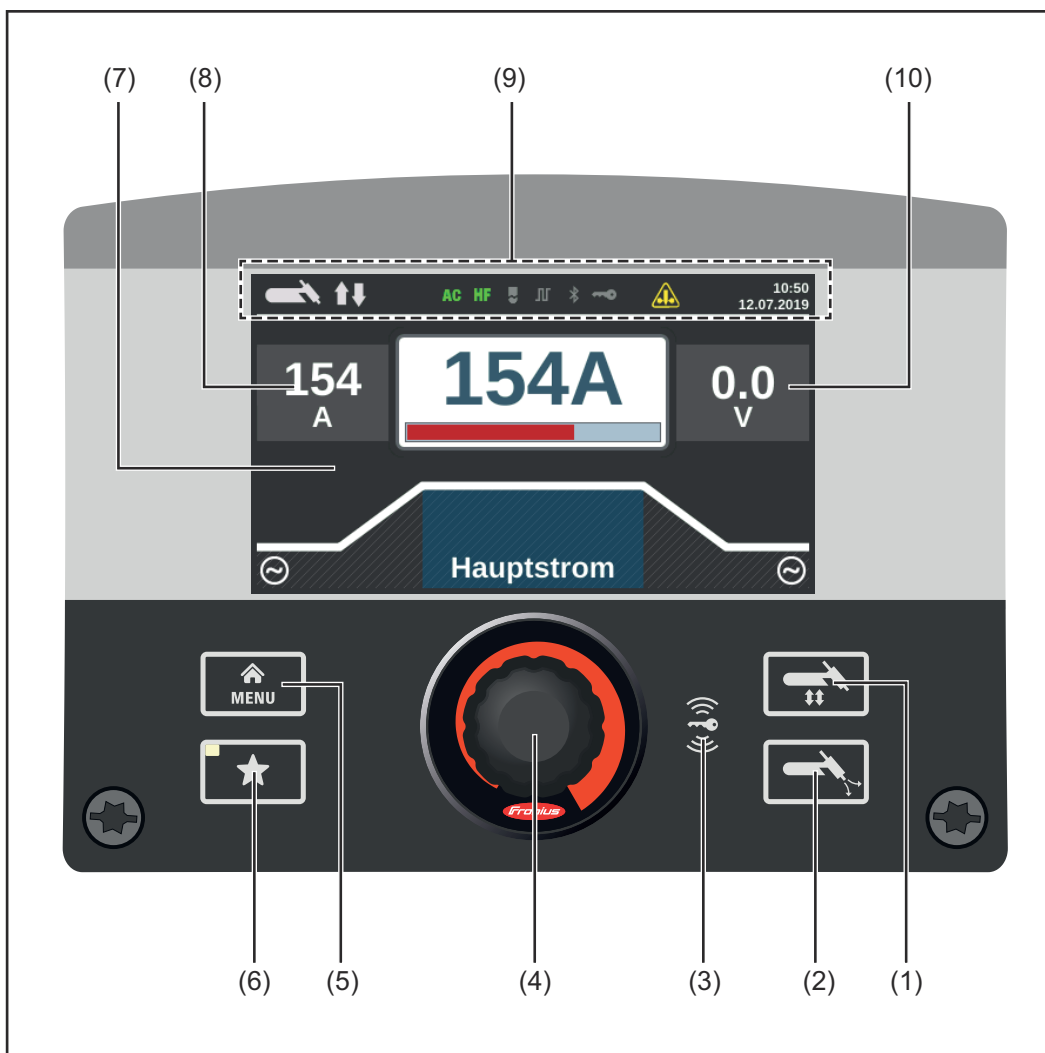

No.	Function
(1)	<p><b>Mode/welding process button</b> For selecting welding processes and mode</p>
(2)	<p><b>Gas-test button</b> To set the required shielding gas flow rate on the gas pressure regulator After pressing the gas-test button, shielding gas flows for 30 seconds. Press the button again to stop the gas flow prematurely.</p>
(3)	<p><b>Key card reader for NFC keys</b> Only in certified countries To lock/unlock the power source using NFC keys</p> <p>NFC key = NFC card or NFC key ring</p>
(4)	<p><b>Adjusting dial with turn/press function</b></p> <ul style="list-style-type: none"> <li>- To select elements, set values and scroll through lists</li> <li>- To save jobs when the FP Job function package is present: if the adjusting dial is pressed for more than 3 seconds, the selected welding parameters are saved as a job. An overview of the most important parameters will be displayed. For more about how to save a job, see Setup settings / the Job menu / Save job starting on page <a href="#">115</a></li> </ul>
(5)	<p><b>Menu key</b> To open the Setup menu</p>
(6)	<p><b>Favourites button</b> To save/retrieve preferred settings</p>
(7)	<p><b>Display</b></p>
(8)	<p><b>Hold indicator - welding current</b> At the end of each welding operation, the actual values for the welding current and welding voltage are stored - HOLD lights up.</p>
(9)	<p><b>Status bar</b> The status bar displays the following information:</p> <ul style="list-style-type: none"> <li>- Current welding process</li> <li>- Current operating mode</li> <li>- Selected current type</li> <li>- Active functions (e.g. high frequency ignition, tacking, pulsing, etc.)</li> <li>- Indication of electrode overload</li> <li>- Status of the power source (locked/unlocked)</li> <li>- Active Bluetooth connection</li> <li>- Time</li> <li>- Date</li> </ul> <p>The information shown in the status bar varies according to which welding process has been selected.</p>
(10)	<p><b>Hold indicator - welding voltage</b> At the end of each welding operation, the actual values for the welding current and welding voltage are stored - HOLD lights up.</p>

# The favourites button

## Assigning the Favourites button

The Favourites button can be assigned a parameter from the following Setup menus:



This parameter can then be called up and changed directly on the control panel.

- 1 Select the desired parameter in the Setup menu

More information about the Setup menu can be found from page [87](#) onwards

- 2 To assign the selected parameter to the Favourites button, press the Favourites button for approx. 5 seconds



A confirmation message is displayed.

- 3 Press the adjusting dial to confirm

The selected parameter is now assigned to the Favourites button.

**IMPORTANT!** Saving a favourite overwrites the previously saved favourite without warning.

## Retrieving favourites

- 1 Press the Favourites button briefly



The assigned parameter is displayed:

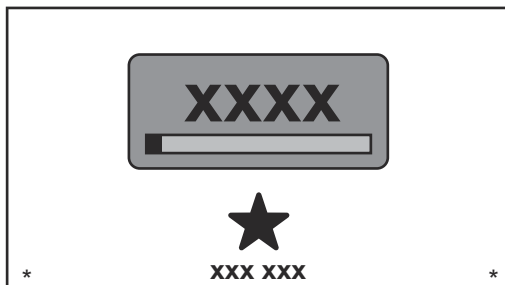

The retrieved parameter can be changed by turning the adjusting dial (blue background).

The new value takes effect immediately.

Press and turn the adjusting dial to choose from the available welding parameters.

---

## Deleting favourites

- 1 Press the Favourites button for longer than 5 seconds



The assigned parameter is deleted and a message is displayed.

- 2 Press the adjusting dial to confirm
- 

## Assigning EasyJobs to the Favourites button

If the FP Job function package is present on the power source, EasyJobs can be assigned to the Favourites button.

**IMPORTANT!** If EasyJobs are assigned to the Favourites button, any previously saved favourite parameter will no longer be accessible using that button.

- 1 Select the Job menu from the Setup menu

More information about the Setup menu can be found from page [115](#) onwards

- 2 In the Job menu, set the "EasyJobs on favorites button" parameter to "on"

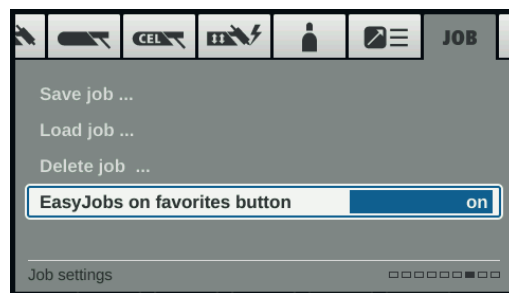

- 3 Press the Menu key



Five EasyJob buttons for the welding parameters are displayed as icons.

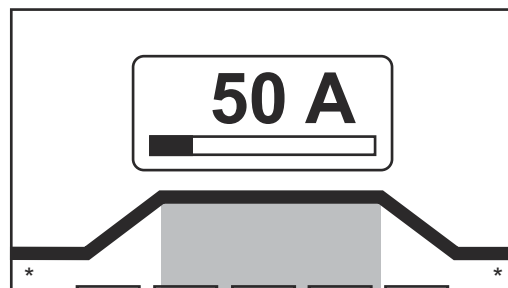

4 Press the Favourites button



The 5 EasyJob buttons are displayed and can be selected by turning and pressing the adjusting dial.

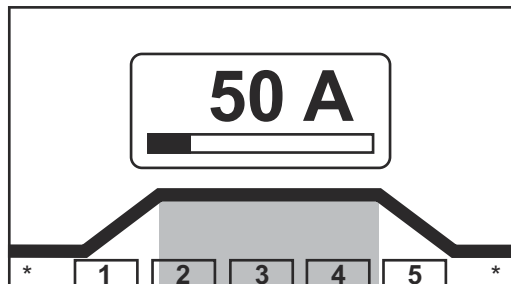

More information about using EasyJobs can be found in the "EasyJob mode" section starting on page [82](#).

# Connections, switches and mechanical components

## Connections, switches and mechanical components

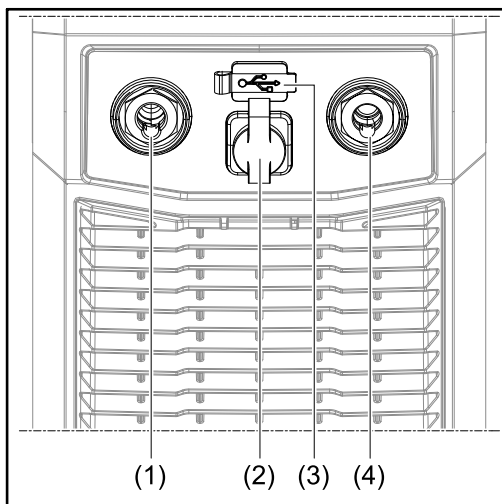

Front

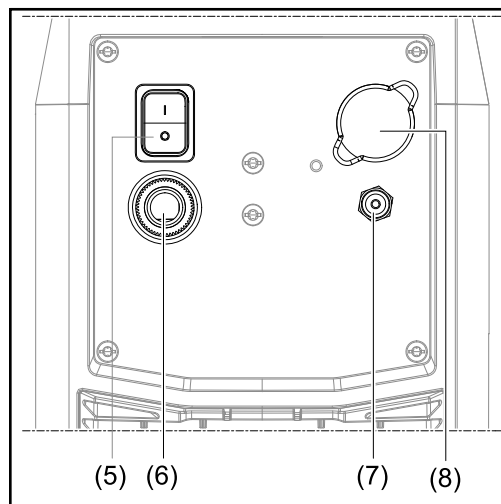

Rear

No.	Function
-----	----------

(1)	<b>(-) current socket with integrated gas connection</b>
-----	--

To connect:

- the TIG welding torch
- the electrode cable for manual metal arc welding

Symbols on iWave DC power sources:



Symbols on iWave AC/DC power sources:



(2)	<b>TMC connection (TIG Multi Connector)</b>
-----	---

- to connect the TIG welding torch control plug
- to connect pedal remote controls
- to connect the remote control during MMA welding

(3)	<b>USB port</b>
-----	-----------------

For connecting USB flash drives (such as service dongles and licence keys).  
**IMPORTANT!** The USB port is not electrically isolated from the welding circuit. This means that devices that establish an electrical connection with another device must not be connected to the USB port.

(4)	<b>(+) current socket</b>
-----	---------------------------

For connecting the grounding cable

Symbols on iWave DC power sources:





Symbols on iWave AC/DC power sources

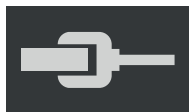

---

**(5) Mains switch**

For switching the power source on and off

Mains switch for MV devices:

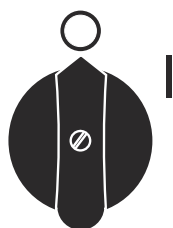

---

**(6) Mains cable with strain relief device**

On MV devices:

Mains cable connection

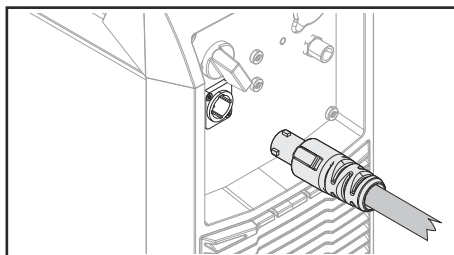

---

**(7) Shielding gas connection**

---

**(8) Blanking cover**

for Ethernet option

---



# **Installation and commissioning**



# Minimum equipment needed for welding task

---

## General

Depending on which welding process you intend to use, a certain minimum equipment level will be needed in order to work with the power source. The welding processes and the minimum equipment levels required for the welding task are then described.

---

## TIG AC welding

- Power source iWave AC/DC
  - Grounding cable
  - TIG welding torch with rocker switch
  - Gas connection (shielding gas supply), with pressure regulator
  - Filler metals (as required by the application)
- 

## TIG DC welding

- Power source
  - Grounding cable
  - TIG welding torch
  - Shielding gas supply with pressure regulator
  - Filler metals (as required by the application)
- 

## MMA welding

- Power source
- Grounding (earthing) cable
- Electrode holder
- Rod electrodes (as required by the application)

# Before installation and commissioning

---

## Safety



### WARNING!

#### **Danger from incorrect operation and work that is not carried out properly.**

This can result in serious personal injury and damage to property.

- ▶ All the work and functions described in this document must only be carried out by technically trained and qualified personnel.
  - ▶ Read and understand this document in full.
  - ▶ Read and understand all safety rules and user documentation for this device and all system components.
- 

## Utilisation for intended purpose

The power source is intended exclusively for TIG and MMA welding. Utilisation for any other purpose, or in any other manner, shall be deemed to be not in accordance with the intended purpose. The manufacturer shall not be liable for any damage resulting from such improper use.

Proper use also includes:

- following all the information in the operating instructions
  - carrying out all the specified inspection and servicing work
- 

## Setup regulations

The device is tested to IP 23 protection, meaning:

- Protection against penetration by solid foreign bodies with diameters > 12.5 mm (0.49 in.)
- Protection against spraywater at any angle up to 60° to the vertical

The device can be set up and operated outdoors in accordance with degree of protection IP 23.

Avoid direct wetting (e.g. from rain).



### WARNING!

#### **Danger from machines toppling over or falling.**

This can result in serious personal injury and damage to property.

- ▶ Set up the device securely on an even, solid surface.
  - ▶ Check all screw connections are tightly fastened after installation.
- 

The venting duct is a very important safety device. When choosing the installation location, ensure that the cooling air can enter and exit unhindered through the air ducts on the front and back of the device. Electroconductive metallic dust must not be allowed to get sucked directly into the device (e.g. from grinding work).

---

## Mains connection

The devices are designed for the mains voltage specified on the rating plate. If your version of the appliance does not come with mains cables and plugs ready-fitted, these must be fitted in accordance with national regulations and standards. For details of fuse protection of the mains lead, please see the technical data.

**⚠ CAUTION!**

**Danger due to insufficiently dimensioned electrical installations.**

This can result in damage to property.

- ▶ Dimension the mains lead and its fuse to suit the local power supply. The technical data shown on the rating plate applies.

**Generator-powered operation**

The power source is generator-compatible.

In order to dimension the required generator output, the maximum apparent power  $S_{1\max}$  of the power source is required.

The maximum apparent power  $S_{1\max}$  of the power source can be calculated as follows:

$$S_{1\max} = I_{1\max} \times U_1$$

See device rating plate or technical data for  $I_{1\max}$  and  $U_1$  values

The generator apparent power  $S_{\text{GEN}}$  needed is calculated using the following rule of thumb:

$$S_{\text{GEN}} = S_{1\max} \times 1.35$$

A smaller generator may be used when not welding at full power.

**IMPORTANT!** The generator apparent power  $S_{\text{GEN}}$  must always be higher than the maximum apparent power  $S_{1\max}$  of the power source.

When using single-phase devices with a 3-phase generator, note that the specified generator apparent power is often only available as a whole across all three phases of the generator. If necessary, obtain further information on the single-phase power of the generator from the generator manufacturer.

**NOTE!**

**The voltage delivered by the generator must never exceed the upper or lower limits of the mains voltage tolerance range.**

Details of the mains voltage tolerance can be found in the "Technical data" section.

# Connecting the mains cable

---

## General

If power sources are delivered without a mains cable fitted, a mains cable that is suitable for the connection voltage must be connected to the power source before commissioning.

The mains cable is included in the scope of supply of the power source.

---

## Safety



### WARNING!

#### **Danger from incorrect operation and work that is not carried out properly.**

This can result in serious personal injury and damage to property.

- ▶ All the work and functions described in this document must only be carried out by technically trained and qualified personnel.
  - ▶ Read and understand this document in full.
  - ▶ Read and understand all safety rules and user documentation for this device and all system components.
- 

## Connecting the mains cable

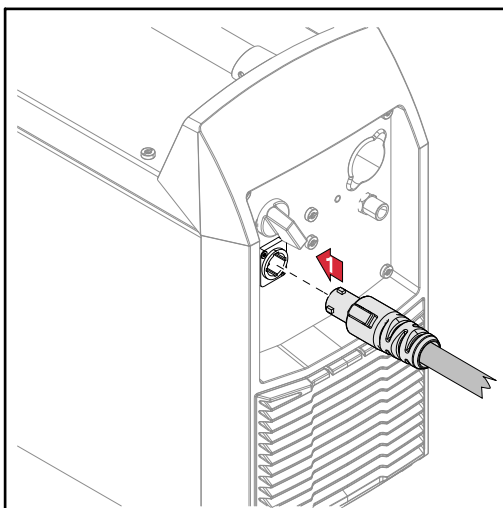

- 1 Connect the mains cable:
  - Plug in the mains cable
  - Turn the mains cable 45° to the right until you hear it latch into place



## Safety



### WARNING!

#### **Danger from electrical current.**

This can result in serious personal injury and damage to property.

- ▶ Before starting work, switch off all devices and components involved and disconnect them from the grid.
- ▶ Secure all devices and components involved so they cannot be switched back on.
- ▶ After opening the device, use a suitable measuring instrument to check that electrically charged components (such as capacitors) have been discharged.



### WARNING!

#### **Danger of electrical current due to electrically conductive dust in the device.**

This can result in severe personal injury and damage to property.

- ▶ Only operate the device if an air filter is fitted. The air filter is a very important safety device for achieving IP 23 protection.

## Remarks on the cooling unit

The iWave 230i DC and iWave 230i AC/DC power sources can be operated with a cooling unit.

A cooling unit is recommended for the following applications:

- Hosepacks over 5 m long
- TIG AC welding
- In general, where welding is performed in higher power ranges

The cooling unit is powered from the power source. The cooling unit is ready for operation when the mains switch of the power source is in the "I" position.

More information on the cooling unit can be found in the Operating Instructions for the cooling unit.

## General

This section describes how to commission the power source:

- for the main TIG welding application
- with reference to a standard configuration for a TIG welding system

The standard configuration consists of the following system components:

- Power source
- TIG manual welding torch
- Pressure regulator
- Gas cylinder

## Fitting the system components

For more detailed information about installing and connecting the system components, please refer to the appropriate Operating Instructions.

## Connecting the gas cylinder

### **WARNING!**

- There is a high risk of very serious injury and damage if a gas cylinder falls over.**
- ▶ Place gas cylinders on a solid, level surface in such a way that they remain stable.
  - ▶ Secure gas cylinders to prevent them from toppling over: Fix the safety strap at the same height as the top part of the cylinder.
  - ▶ Never fix the safety strap around the neck of the cylinder.
  - ▶ Observe the safety rules of the gas cylinder manufacturer.

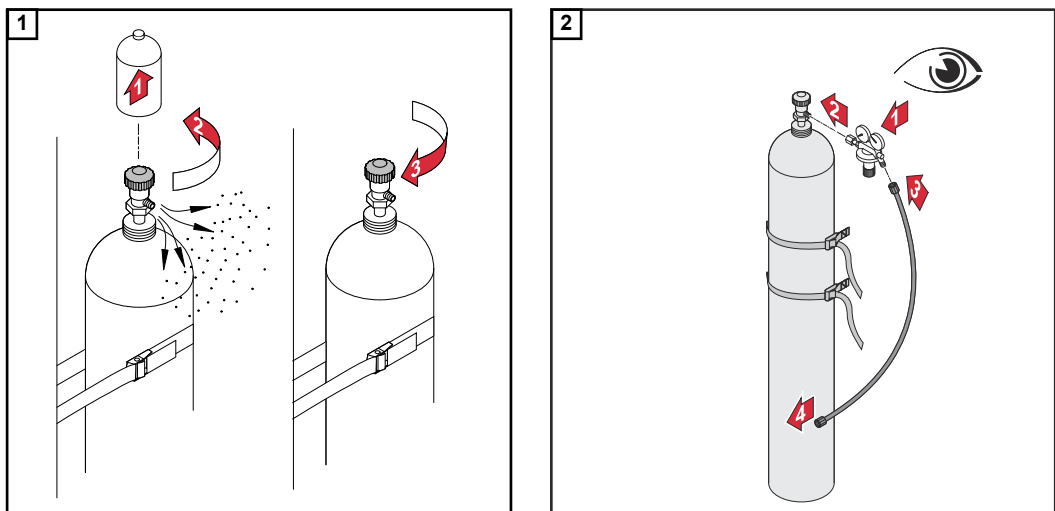

### When using a TIG welding torch with an integral gas connection:

- 3 Use the gas hose to connect the pressure regulator to the shielding gas connection on the rear of the power source
- 4 Tighten the union nut on the gas hose

### When using a TIG welding torch with no integral gas connection:

- 3 Connect the TIG welding torch gas hose to the pressure regulator

### **NOTE!**

When using a MultiControl (MC) cooling unit, please see the Operating Instructions of the cooling unit for a description of the gas connection.

## Connecting the welding torch to the power source and the cooling unit

### **NOTE!**

Do not use pure tungsten electrodes (colour-coded green) on iWave DC power sources.

- 1 Set up the welding torch in accordance with the welding torch Operating Instructions

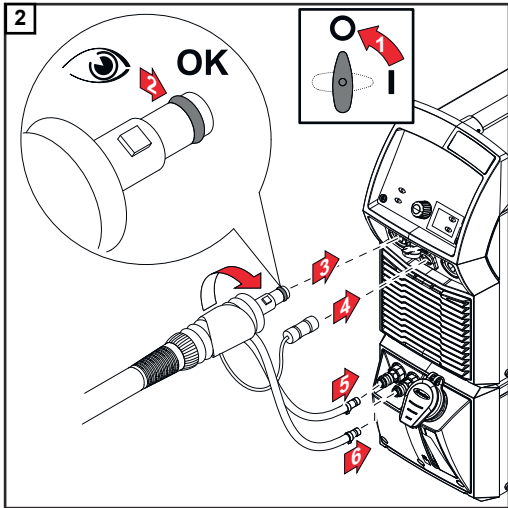

During welding, check at regular intervals that the coolant is flowing properly.

**NOTE!**

- Before each start-up:**
- ▶ Check the sealing ring on the welding torch connection.
  - ▶ Check coolant level.

**Establishing a ground earth connection to the workpiece**

**1** Turn the mains switch to the "O" position

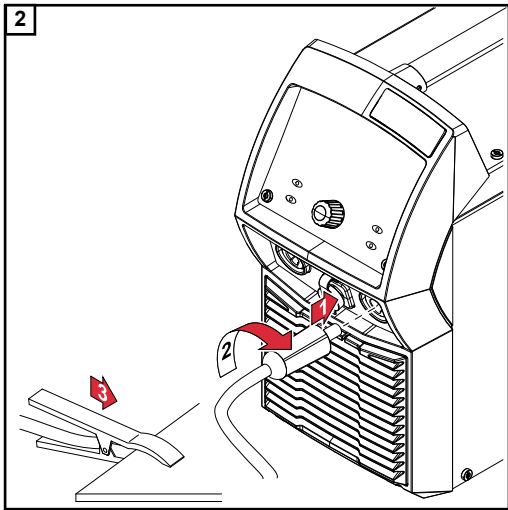

# Locking and unlocking the power source using the NFC key

## General

NFC key = NFC card or NFC key ring

The power source can be locked using an NFC key, e.g. to prevent unauthorised access or welding parameters being changed without permission.

A contactless system on the control panel allows the power source to be locked and unlocked.

The power source must be switched on before it can be locked or unlocked.

## Limitations

Locking and unlocking of the power source is only permitted in certified countries.

## Locking and unlocking the power source using the NFC key

### Locking the power source



- 1 Hold the NFC key on the NFC key reader

The key icon in the status bar lights up.

The power source is now locked. Only the welding parameters can be viewed and adjusted using the adjusting dial.

Any attempt to call a locked function will result in a notification being displayed.

### Unlocking the power source

- 1 Hold the NFC key on the NFC key reader

The key icon in the status bar is no longer lit. All functions of the power source are available again without restriction.

### NOTE!

More information about locking and unlocking the power source can be found in the "Defaults - Management / Administration" section on page [134](#).

# **Welding**



Safety

**⚠ WARNING!**

**Danger from incorrect operation.**

Possible serious injury and damage to property.

- ▶ Do not use the functions described here until you have read and completely understood these Operating Instructions.
- ▶ Do not use the functions described here until you have fully read and understood all of the Operating Instructions for the system components, in particular the safety rules!

See the "The Setup menu" section for information on the settings, setting range and units of measurement of the available welding parameters.

**Symbols and their explanations**

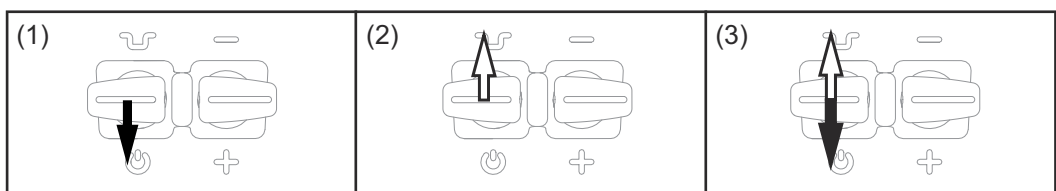

(1) Pull back and hold the torch trigger (2) Release the torch trigger (3) Pull back the torch trigger briefly (< 0.5 s)

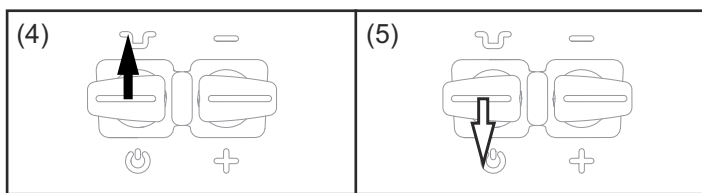

(4) Push forward and hold the torch trigger (5) Release the torch trigger

GPr	Gas pre-flow
SPt	Spot welding time
I <sub>S</sub>	Starting current: Carefully warm up with low welding current to position the filler metal correctly
I <sub>E</sub>	Final current: To avoid local overheating of the base material by heat accumulation at the end of the welding. This eliminates any risk of weld seam drop-through.
t <sub>UP</sub>	UpSlope: The starting current is steadily increased until it reaches the main current (welding current) I <sub>1</sub>
t <sub>DOWN</sub>	DownSlope: Continuous reduction of the welding current until it reaches the final current
I <sub>1</sub>	Main current (welding current): Uniform thermal input into the base material heated by advancing heat

$I_2$	Reduced current: Intermediate lowering of the welding current in order to prevent any local over-heating of the base material
GPO	Gas post-flow

### 2-step mode

- Welding: Pull back and hold the torch trigger
- End of welding: Release the torch trigger

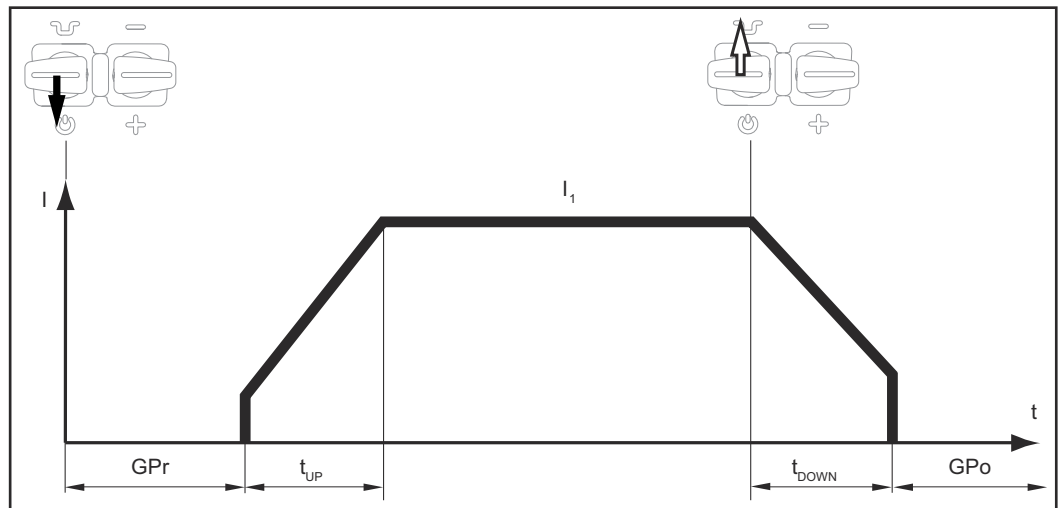

2-step mode

### 4-step mode

- Start of welding with starting current  $I_S$ : Pull back and hold the torch trigger
- Welding with main current  $I_1$ : Release the torch trigger
- Lowering to final current  $I_E$ : Pull back and hold the torch trigger
- End of welding: Release the torch trigger

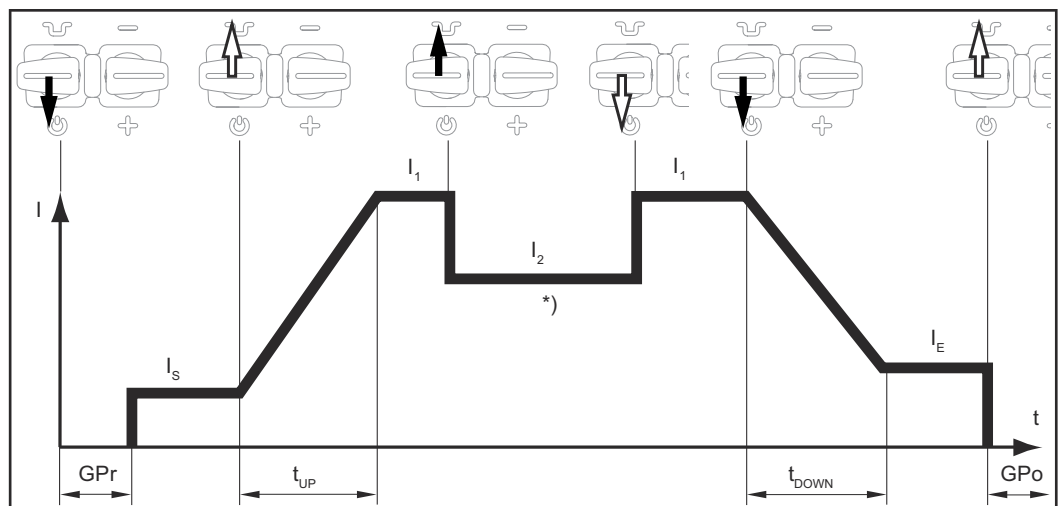

4-step mode

\*) Intermediate lowering

Intermediate lowering during the main current phase reduces the welding current to the specified reduced current  $I_2$ .



- To activate intermediate lowering, push forward and hold the torch trigger
- To revert to the main current, release the torch trigger

**Special 4-step mode:  
Variant 1**

Briefly pull back the torch trigger to start intermediate lowering to the specified reduced current  $I_2$ . Briefly pull back the torch trigger a second time, to restore the main current  $I_1$ .

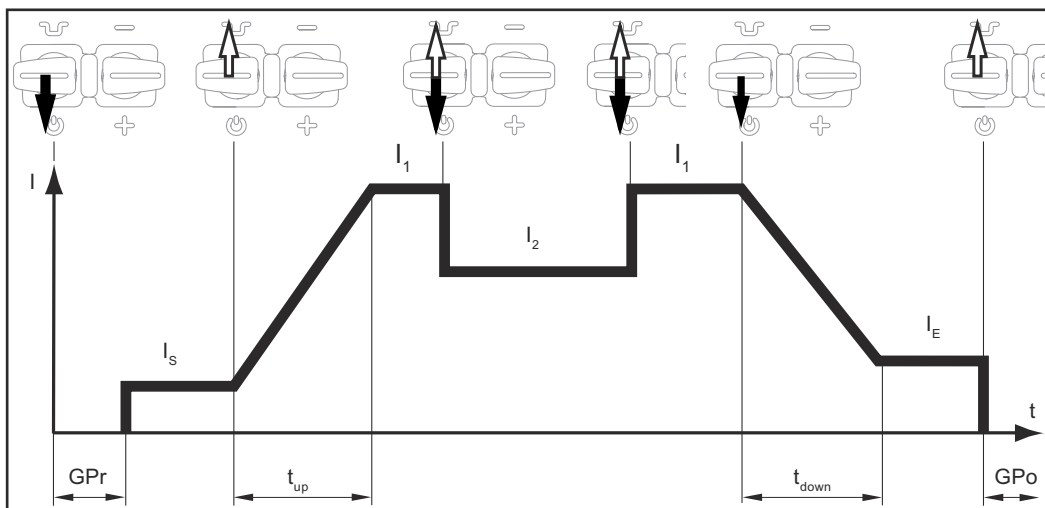

Special 4-step mode: Variant 1

Variant 1 of the special 4-step mode is activated with the following parameter setting:



- Starting current time = off
- Final current time = off
- Reduced current slope 1 = off
- Reduced current slope 2 = off



Operating mode defaults

- $I_2$  via torch trigger = on
- Reduced current button function =  $I_2$

**Special 4-step mode:  
Variant 2**

Intermediate lowering takes place in variant 2 on the basis of the selected reduced current slope 1/2 values:

- Push forward and hold the torch trigger: the welding current continuously drops at the set reduced current slope 1 value until it reaches the specified reduced current  $I_2$ . It remains at the reduced current value  $I_2$  until the torch trigger is released.
- When the torch trigger is released: the welding current rises at the specified reduced current slope 2 value until it reaches the main current value  $I_1$ .

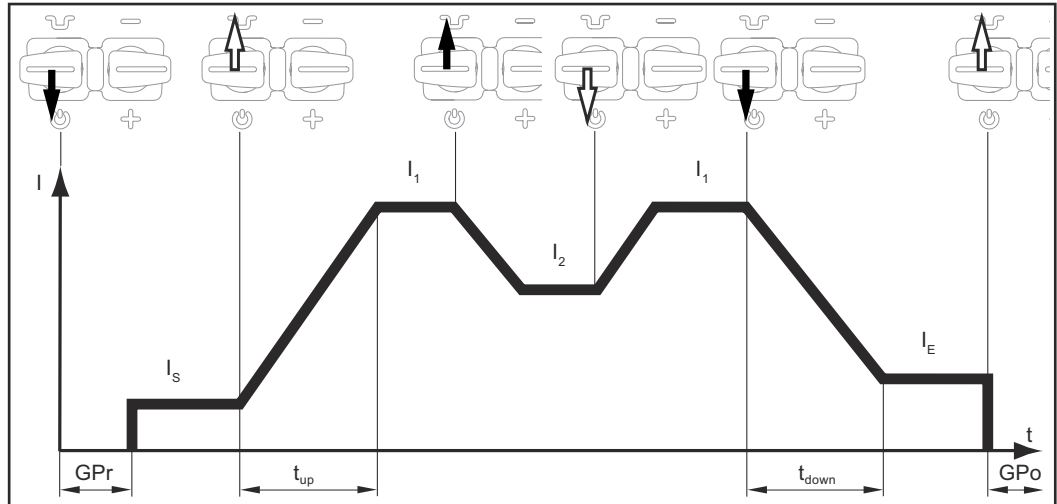

Special 4-step mode: Variant 2

Variant 2 of the special 4-step mode is activated with the following parameter setting:



- Starting current time = off
- Final current time = off
- Reduced current slope 1 = on
- Reduced current slope 2 = on



Operating mode defaults

- I2 via torch trigger = off
- Reduced current button function = I2

**Special 4-step mode:  
Variant 3**

In variant 3, push forward and hold the torch trigger to start intermediate lowering of the welding current. Release the torch trigger to resume the main current  $I_1$ .

When the torch trigger is pulled back, welding ends immediately without DownSlope and final current.

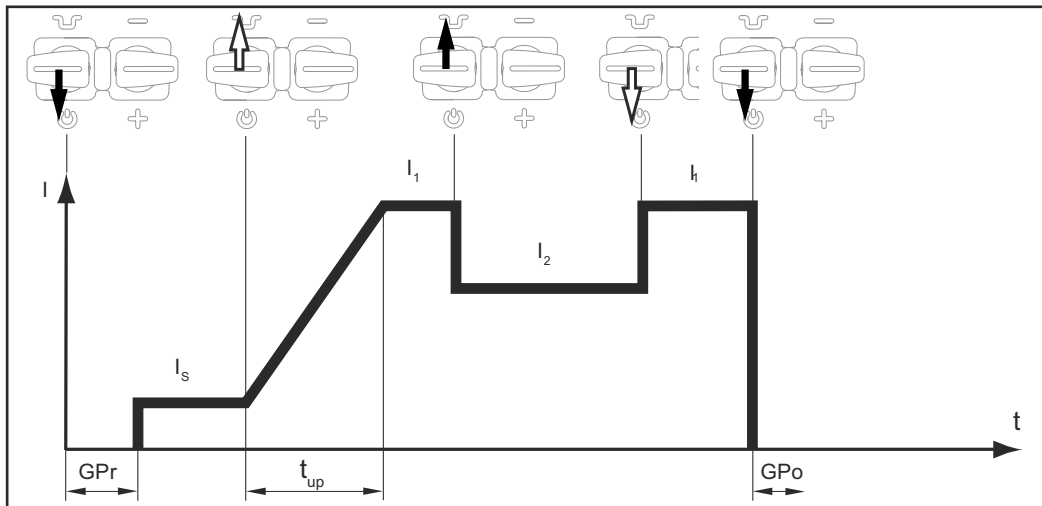

*Special 4-step mode: Variant 3*

Variant 3 of the special 4-step mode is activated with the following parameter setting:



- Starting current time = off
- Final current time = 0.01 s
- Reduced current slope 1 = off
- Reduced current slope 2 = off



Operating mode defaults

- I2 via torch trigger = off
- Reduced current button function = I2

**Special 4-step mode:  
Variant 4**

- Welding start-up and welding: briefly pull back and release the torch trigger - the welding current will rise at the specified UpSlope value from the starting current  $I_s$  until it reaches the main current value  $I_1$ .
- Push forward and hold the torch trigger for intermediate lowering
- Release the torch trigger to resume the main current  $I_1$
- End of welding: briefly pull back and release the torch trigger

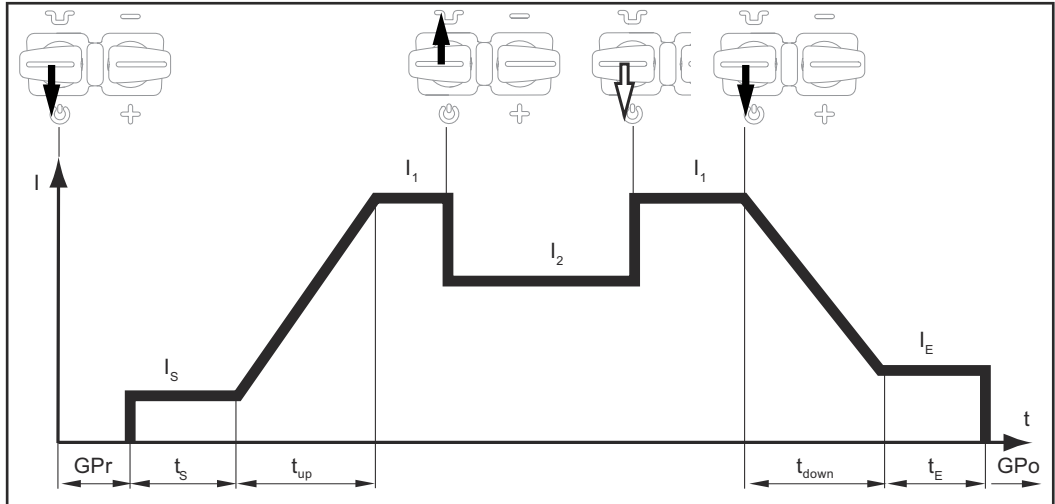

Special 4-step mode: Variant 4

Variant 4 of the special 4-step mode is activated with the following parameter setting:



- Starting current time = on
- Final current time = on
- Reduced current slope 1 = off
- Reduced current slope 2 = off



Operating mode defaults

- I2 via torch trigger = off
- Reduced current button function = I2

**Special 4-step mode:  
Variant 5**

Variant 5 allows the welding current to be increased and reduced without an Up/Down torch.

- The longer the torch trigger is held in the forward position during welding, the more the welding current increases (up to the maximum).
- The welding current remains constant when the torch trigger is released.
- The longer the torch trigger is pushed forward again, the more the welding current decreases.

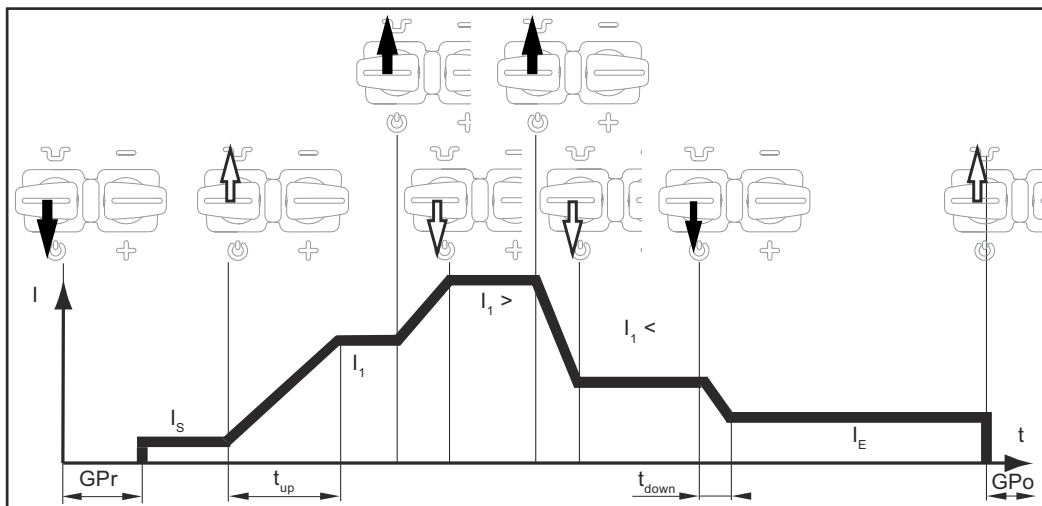

Special 4-step mode: Variant 5

Variant 5 of the special 4-step mode is activated with the following parameter setting:



- Starting current time = off
- Final current time = off
- Reduced current slope 1 = off
- Reduced current slope 2 = off



Operating mode defaults

- I2 via torch trigger = off or on
- Reduced current button function = I1

**Special 4-step mode:  
Variant 6**

- Welding start-up with starting current  $I_s$  and UpSlope: Pull back and hold the torch trigger
- Intermediate lowering to  $I_2$  and changing from  $I_2$  back to the main current  $I_1$ : briefly press ( $< 0.5$  s) and release the torch trigger
- End the welding process: press the torch trigger for longer ( $> 0.5$  s) and release.

The process is automatically ended after the DownSlope phase and the final current phase.

If the torch trigger is pressed briefly ( $< 0.5$  s) and released during either the DownSlope phase or the final current phase, then an UpSlope will take effect until it reaches the main current and the welding process will continue.

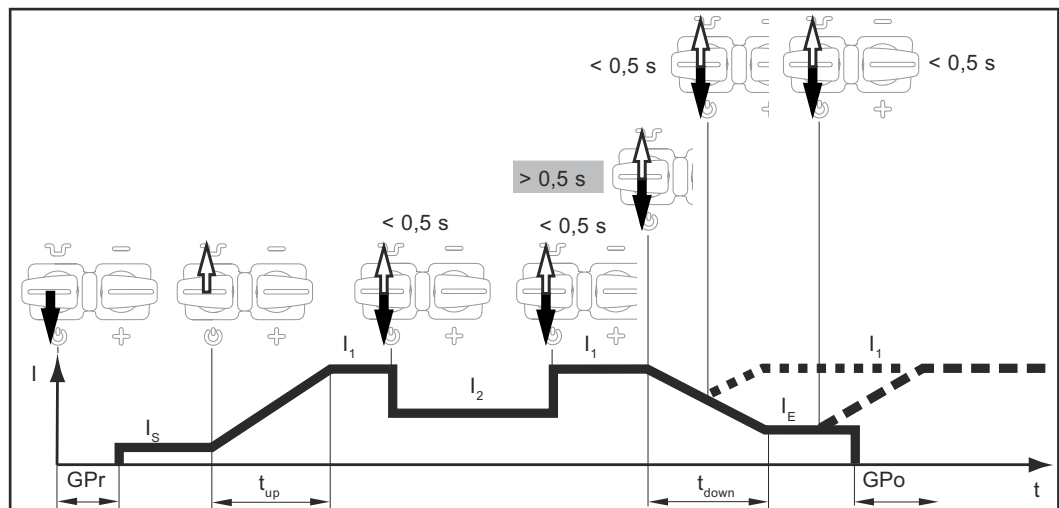

Special 4-step mode: Variant 6

Variant 6 of the special 4-step mode is activated with the following parameter setting:



- Starting current time = off
- Final current time = on
- Reduced current slope 1 = off
- Reduced current slope 2 = off



Operating mode defaults

- I2 via torch trigger = on
- Reduced current button function = I2

## Spot welding

When the spot welding operating mode is selected, the symbol for spot welding appears on the status indicator next to the welding process symbol:



- Welding: briefly pull back the torch trigger  
The welding time corresponds to the value set for the spot welding time setup parameter.
- To end the welding process prematurely: pull the torch trigger back again

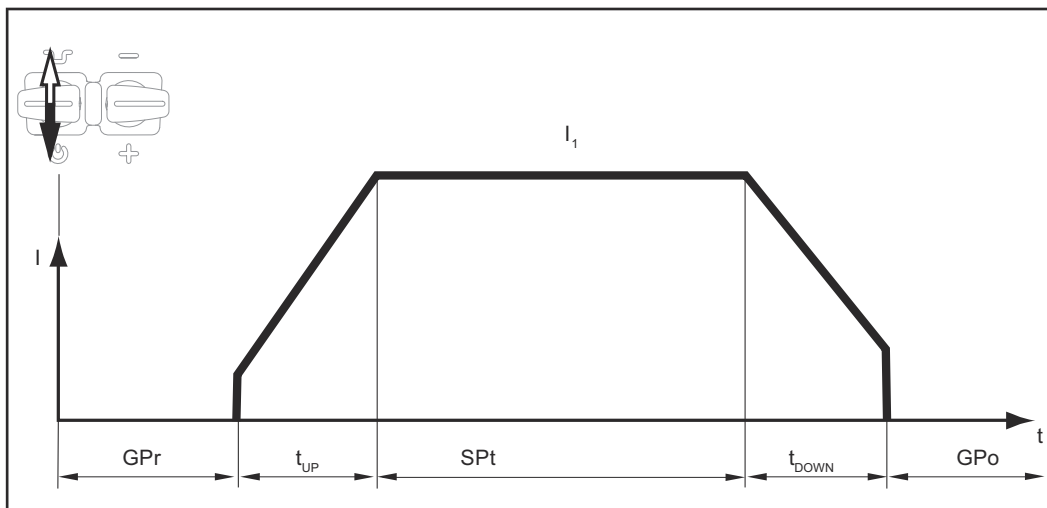

## CycleTIG

### CycleTIG

Enhanced stitch welding process for DC welding

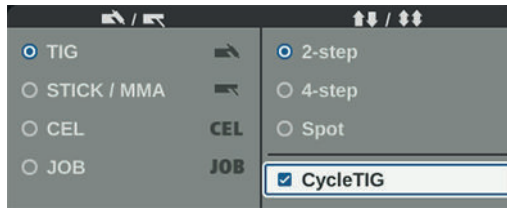

*CycleTig activated*

When the CycleTIG function is activated, the following parameters are available:

- (1) Interval time
- (2) Interval break time
- (3) Interval cycles
- (4) Base current

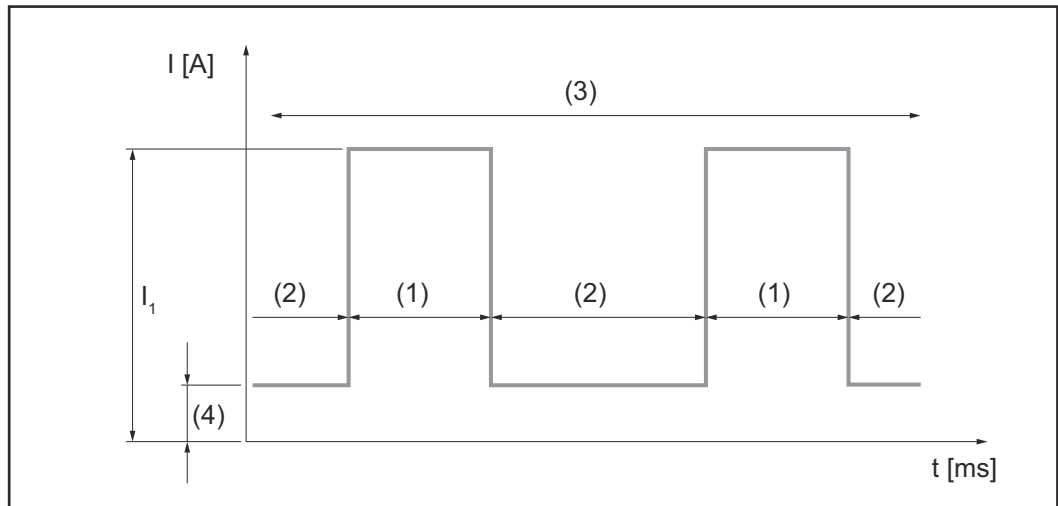

#### **NOTE!**

For more details on CycleTIG, see from page [73](#).  
Description of the CycleTIG parameters from page [62](#).



## Safety

### **WARNING!**

#### **Danger from incorrect operation and work that is not carried out properly.**

This can result in serious personal injury and damage to property.

- ▶ All the work and functions described in this document must only be carried out by technically trained and qualified personnel.
- ▶ Read and understand this document in full.
- ▶ Read and understand all safety rules and user documentation for this device and all system components.

### **WARNING!**

#### **Danger from electrical current.**

This can result in serious personal injury and damage to property.

- ▶ Before starting work, switch off all devices and components involved and disconnect them from the grid.
- ▶ Secure all devices and components involved so they cannot be switched back on.
- ▶ After opening the device, use a suitable measuring instrument to check that electrically charged components (such as capacitors) have been discharged.

## Preparation

- 1 Plug in the mains plug

### **CAUTION!**

#### **Risk of injury and damage to property from electric shock.**

As soon as the mains switch is in the "I" position, the tungsten electrode of the welding torch is live.

- ▶ Ensure that the tungsten electrode does not touch any persons or electrically conductive or earthed parts (e.g. housing, etc.).

- 2 Move the mains switch to the "I" position

The Fronius logo appears on the display.

## TIG welding

- 1 Press the welding process / operating mode key



The welding processes and operating modes are displayed.

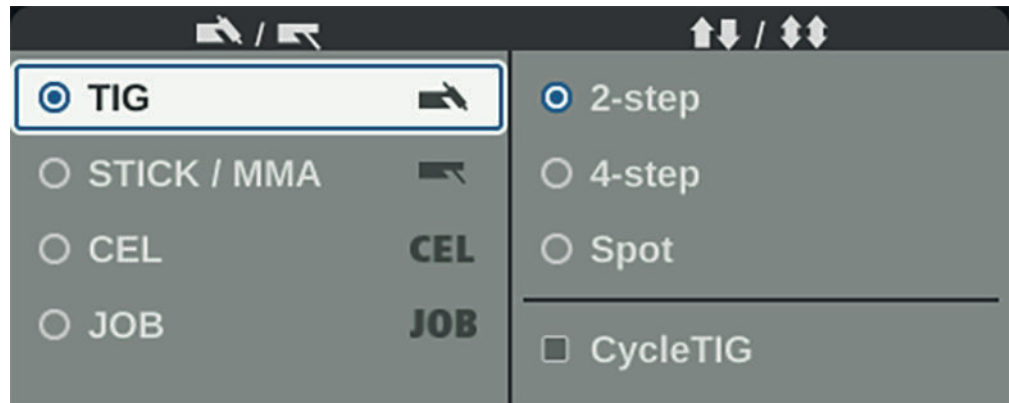

- 2 Select the desired welding process by turning the adjusting dial
- 3 Confirm the selection by pressing the adjusting dial
- 4 Select the desired operating mode by turning the adjusting dial
- 5 Confirm the selection by pressing the adjusting dial

After a short period of time or after pressing the welding process / operating mode key, the available TIG welding parameters are displayed.

- 6 Turn the adjusting dial to select the required parameter
- 7 Press the adjusting dial

The value of the welding parameter is highlighted in blue and can now be changed.

- 8 Turn the adjusting dial: change the value of the parameter
- 9 Press the adjusting dial
- 10 If required, set further parameters in the Setup menu  
(For details, see the "Setup settings" chapter, starting on page 87)
- 11 Open the gas cylinder valve
- 12 Press the Gas-test button



The test gas flow lasts for a maximum of 30 seconds. Press the button again to stop the gas flow prematurely.

- 13 Turn the adjusting screw on the underside of the pressure regulator until the manometer indicates the desired shielding gas flow rate

**NOTE!**

All welding parameter set values that have been set using the adjusting dial remain stored until the next time they are changed.

This applies even if the power source was switched off and on again in the interim.

14 Start welding (ignite the arc)

### Welding parameters for TIG DC welding

The polarity welding parameter is only available on iWave AC/DC power sources. If the polarity welding parameter is set to DC-, the following welding parameters are available:

xxA = actual current value depending on the specified main current

#### Starting current

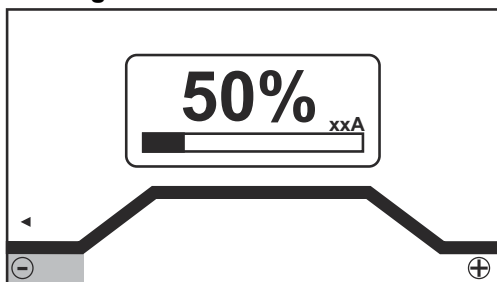

Starting current, 2-step mode and spot welding



Starting current, 4-step mode

Setting range: 0 - 200% (of main current)

Factory setting: 50%

**IMPORTANT!** The starting current is saved separately for TIG AC welding and TIG DC-welding.

#### UpSlope

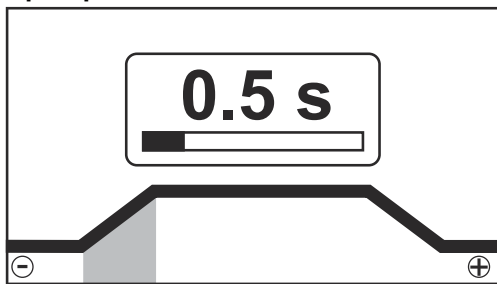

UpSlope, 2-step mode and spot welding

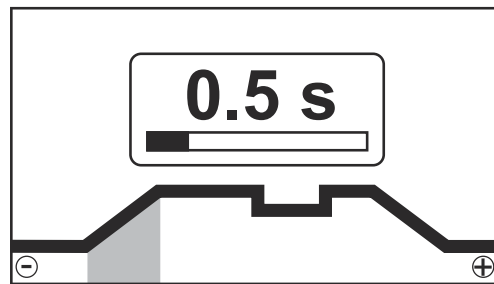

UpSlope, 4-step mode

Setting range: off; 0.1 - 30.0 s

Factory setting: 0.5 s

**IMPORTANT!** The saved UpSlope value applies to both the 2-step and 4-step modes.

## Main current ( $I_1$ )

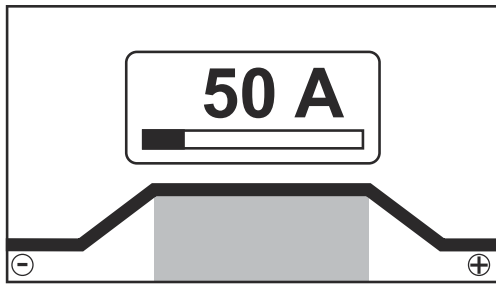

Main current, 2-step mode and spot welding

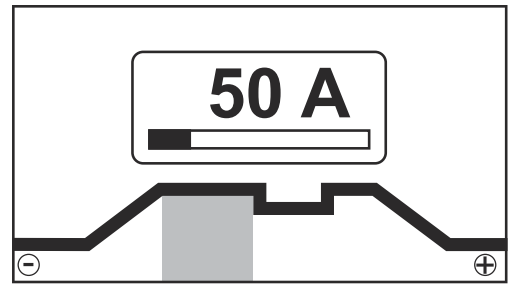

Main current, 4-step mode

Setting range: 3 - 190 A ... iWave 190i, 3 - 230 A ... iWave 230i

Factory setting: -

**IMPORTANT!** On welding torches with the Up/Down Function, the entire setting range can be selected while the device is idling.

## Reduced current ( $I_2$ )

only in 4-step mode

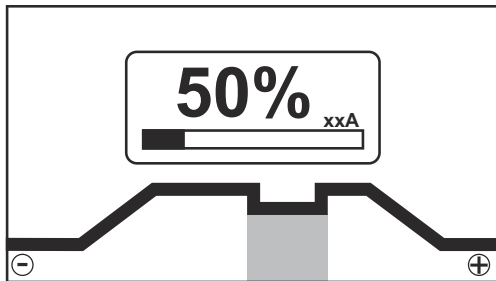

Reduced current  $I_2 < \text{Main current } I_1$

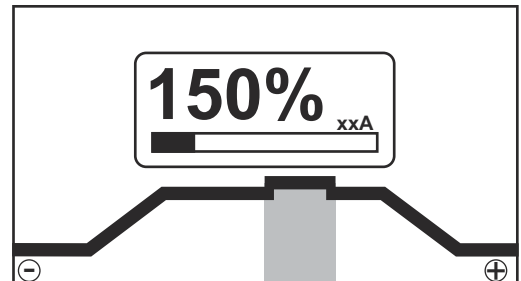

Reduced current  $I_2 > \text{Main current } I_1$

Setting range: 0 - 200% (of main current  $I_1$ )

Factory setting: 50%

$I_2 < 100\%$

short-term, adapted reduction of the welding current  
(e.g. when changing the welding wire during the welding process)

$I_2 > 100\%$

short-term, adjusted increase in welding current  
(e.g. to weld over tacked spots at higher power)

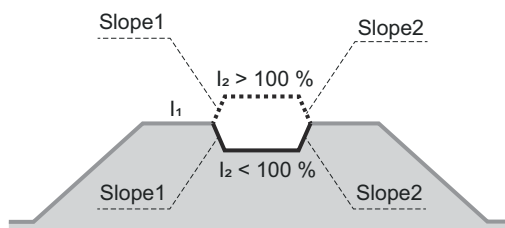

The values for Slope1 and Slope2 can be set using the TIG menu.

### DownSlope

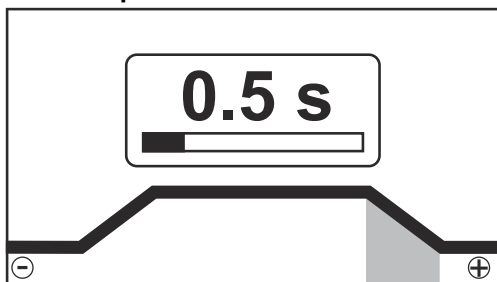

DownSlope, 2-step mode and spot welding

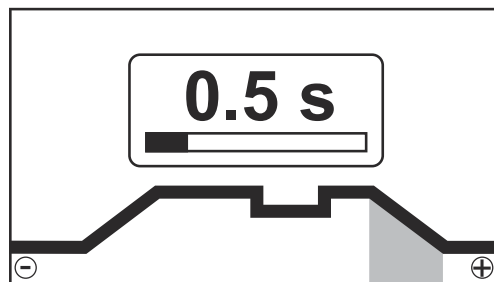

DownSlope, 4-step mode

Setting range: off; 0.1 - 30.0 s

Factory setting: 1.0 s

**IMPORTANT!** The saved DownSlope value applies to both the 2-step and 4-step modes.

### Final current

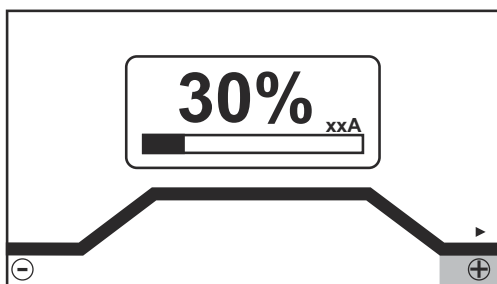

Final current, 2-step mode and spot welding

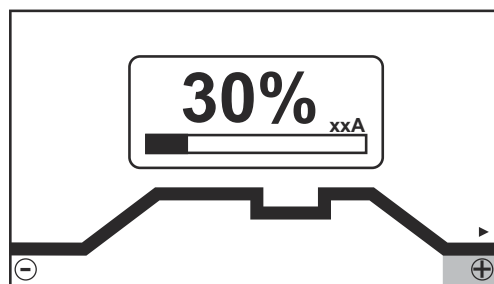

Final current, 4-step mode

Setting range: 0 - 100% (of main current)

Factory setting: 30%

### Electrode diameter

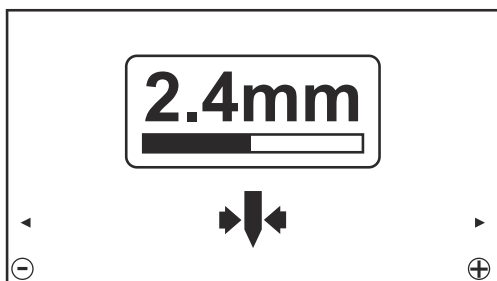

Setting range: off; 1.0 - 4.0 mm

Factory setting: 2.4 mm

## Polarity

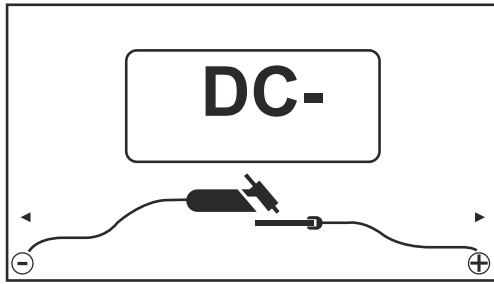

Setting range: DC-/AC  
Factory setting: DC-

---

## CycleTIG welding parameters

If the CycleTIG function is activated, the CycleTIG welding parameters are displayed after the main current for the TIG DC welding parameters:

---

### Interval cycles

for setting how many cycles are to be repeated

Setting range: Permanent / 1 - 2000  
Factory setting: Permanent

---

### Interval time

for setting the length of time the welding current  $I_1$  is active

Setting range: 0.02 - 2.00 s  
Factory setting: 0.5 s

---

### Interval break time

for setting the length of time the base current is active

Setting range: 0.02 - 2.00 s  
Factory setting: 0.5 s

---

### Base current

for setting the interval base current to which the current is reduced during the interval break time

Setting range: off / 3 - max. A  
Factory setting: off

---

## Welding parameters for TIG AC welding

The polarity welding parameter is only available on iWave AC/DC power sources. If the polarity welding parameter is set to AC, the following welding parameters are available:

xxA = actual current value depending on the specified main current

### Starting current

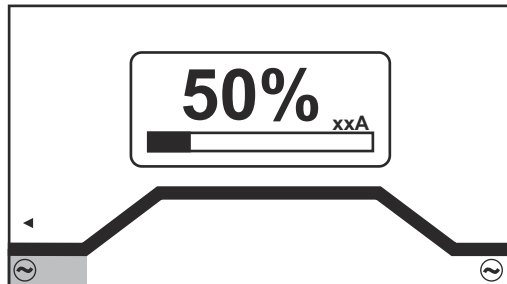

Starting current, 2-step mode and spot welding

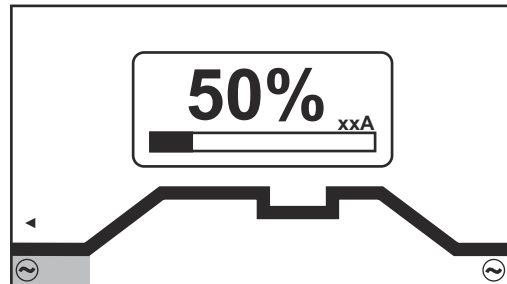

Starting current, 4-step mode

Setting range: 0 - 200% (of main current)  
Factory setting: 50%

**IMPORTANT!** The starting current is saved separately for TIG AC welding and TIG DC-welding.

### UpSlope

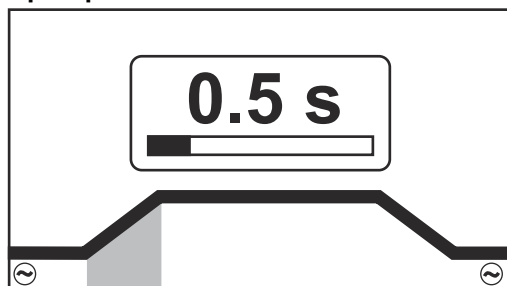

UpSlope, 2-step mode and spot welding

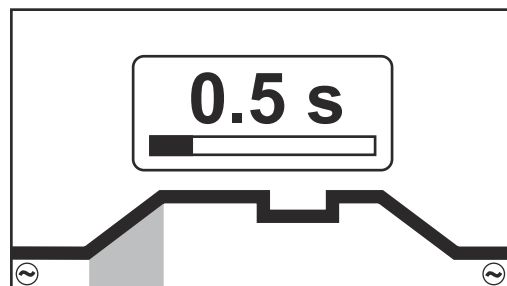

UpSlope, 4-step mode

Setting range: off; 0.1 - 30.0 s  
Factory setting: 0.5 s

**IMPORTANT!** The saved UpSlope value applies to both the 2-step and 4-step modes.

### Main current (I<sub>1</sub>)

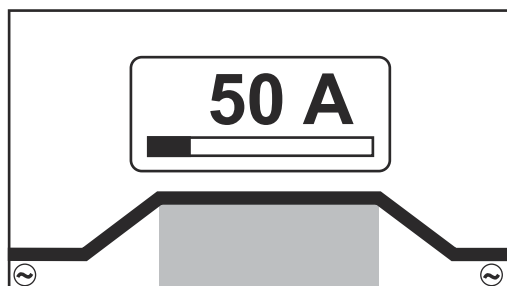

Main current, 2-step mode and spot welding

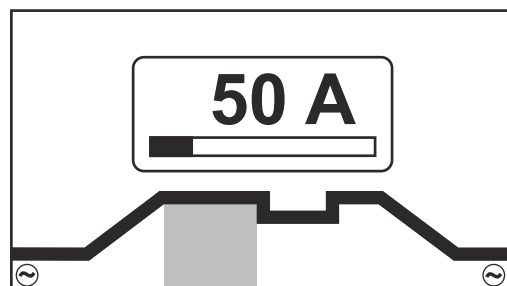

Main current, 4-step mode

Setting range: 3 - 190 A ... iWave 190i, 3 - 230 A ... iWave 230i  
Factory setting: -

**IMPORTANT!** On welding torches with the Up/Down Function, the entire setting range can be selected while the device is idling.

## Reduced current ( $I_2$ )

only in 4-step mode

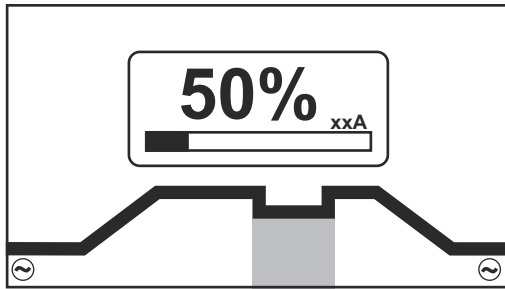

Reduced current  $I_2 < \text{Main current } I_1$

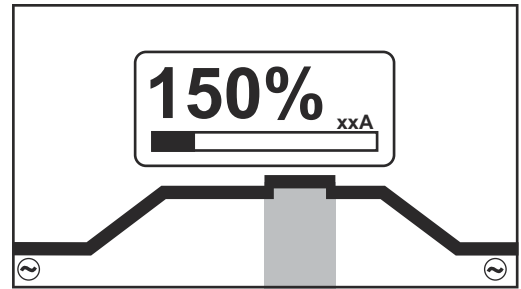

Reduced current  $I_2 > \text{Main current } I_1$

Setting range: 0 - 200% (of main current  $I_1$ )

Factory setting: 50%

$I_2 < 100\%$

short-term, adapted reduction of the welding current  
(e.g. when changing the welding wire during the welding process)

$I_2 > 100\%$

short-term, adjusted increase in welding current  
(e.g. to weld over tacked spots at higher power)

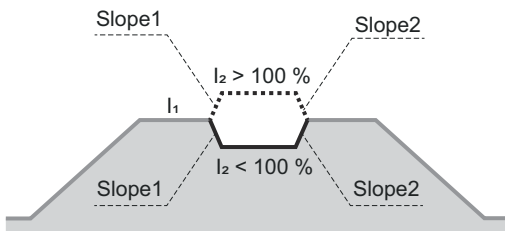

The values for Slope1 and Slope2 can be set using the TIG menu.

## DownSlope

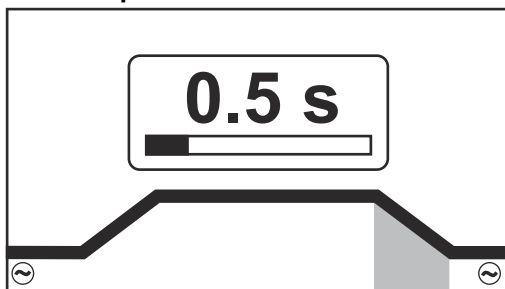

DownSlope, 2-step mode and spot welding

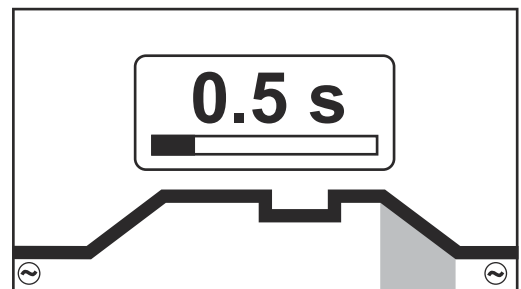

DownSlope, 4-step mode

Setting range: off; 0.1 - 30.0 s

Factory setting: 1.0 s

**IMPORTANT!** The saved DownSlope value applies to both the 2-step and 4-step modes.



**Final current**

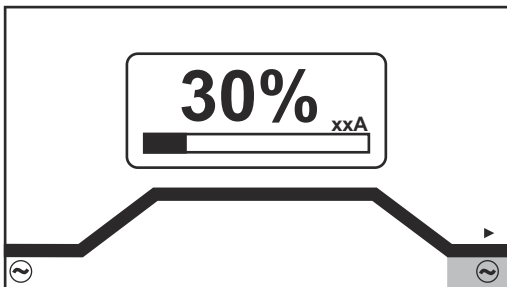

Final current, 2-step mode and spot welding

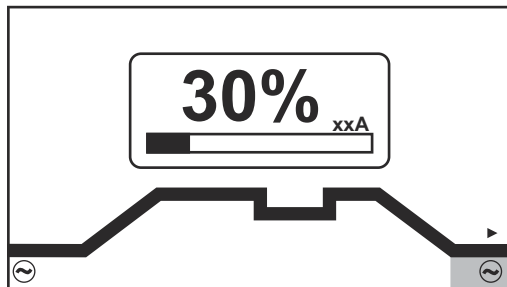

Final current, 4-step mode

Setting range: 0 - 100% (of main current)

Factory setting: 30%

**Balance**

on iWave AC/DC only

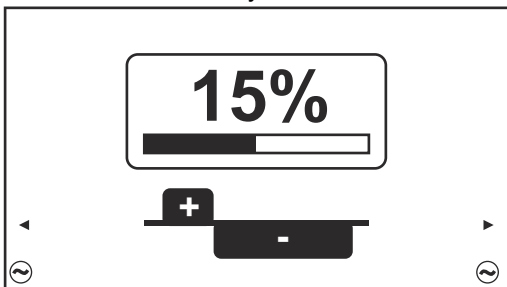

Balance = 15%

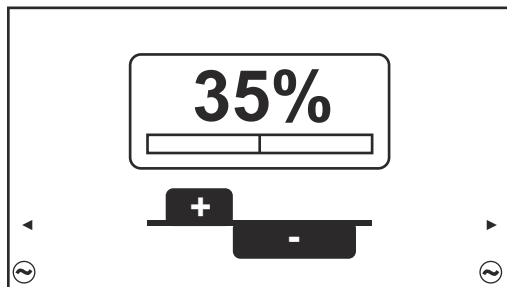

Balance = 35%

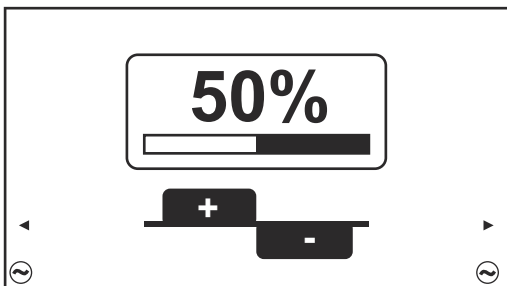

Balance = 50%

Setting range: 15 - 50%

Factory setting: 35%

15: highest fusing power, lowest cleaning action

50: highest cleaning action, lowest fusing power

Effect of the balance on the waveshape:

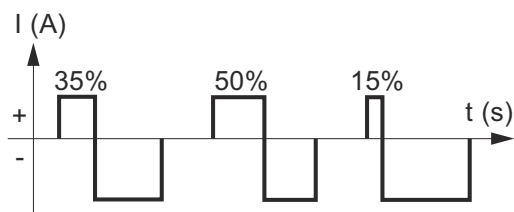

## Electrode diameter

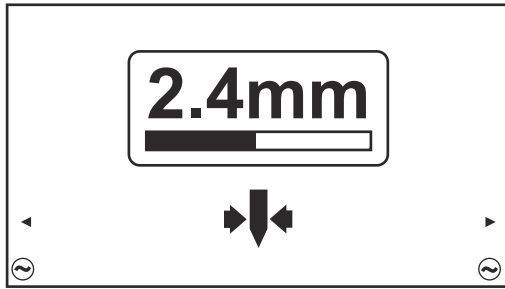

Setting range: off; 1.0 - 4.0 mm  
Factory setting: 2.4 mm

---

## Cap mode

on iWave AC/DC only

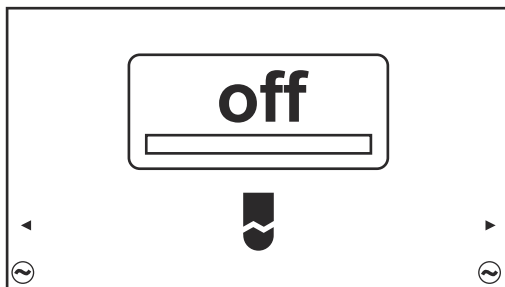

Setting range: off / on  
Factory setting: off

off

Automatic cap-shaping function is deactivated

on

For the entered diameter of the tungsten electrode, the optimum cap is formed during the welding start.

A separate cap-shaping action on a test workpiece is not required.

After this, the automatic cap-shaping function is reset and deactivated again.

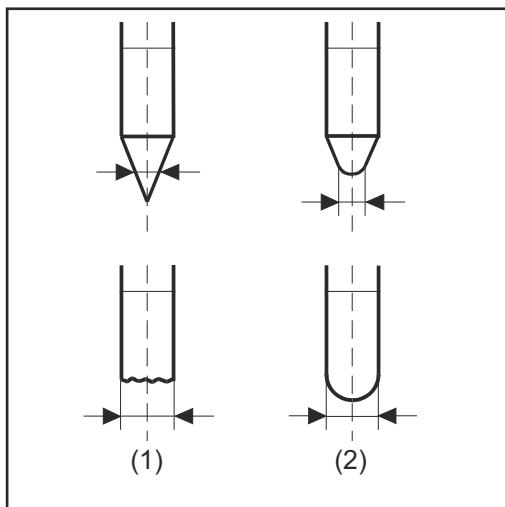

(1) ... before ignition

(2) ... after ignition

Cap mode must be activated separately for each tungsten electrode.

**NOTE!**

The automatic cap-shaping function is not necessary if a sufficiently large cap has already formed at the tip of the tungsten electrode.

---

**Polarity**

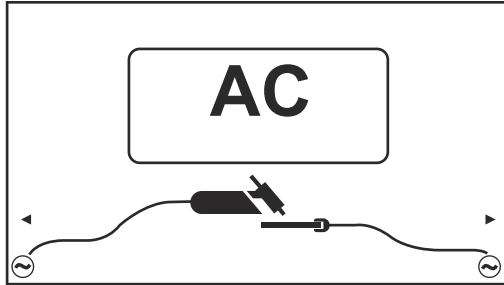

Setting range: DC-/AC  
Factory setting: DC-

---

# Igniting the arc

## General

To ensure the best ignition sequence in the TIG AC welding process, the iWave AC/DC power sources take account of:

- the diameter of the tungsten electrode
- the current temperature of the tungsten electrode with reference to the preceding welding and weld-off times

## Igniting the arc using high frequency (HF ignition)

### ⚠ CAUTION!

#### Risk of injury due to shock caused by electric shock

Although Fronius devices comply with all relevant standards, high-frequency ignition can transmit a harmless but noticeable electric shock under certain circumstances.

- ▶ Use prescribed protective clothing, especially gloves!
- ▶ Only use suitable, completely intact and undamaged TIG hosepacks!
- ▶ Do not work in damp or wet environments!
- ▶ Take special care when working on scaffolding, work platforms, in forced positions (out-of-position welding), in tight, difficult to access or exposed areas!

HF ignition is activated when a time value has been set for the ignition timeout setup parameter in the HF menu.

The HF ignition indicator lights up in the status bar on the control panel.



Unlike touchdown ignition, HF ignition eliminates the risk of contamination of the tungsten electrode and the workpiece.

Procedure for HF ignition:

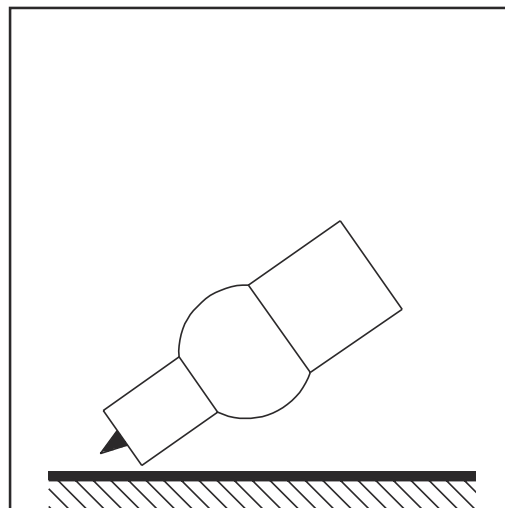

- 1 Place the gas nozzle down on the ignition location, ensuring there is a gap of approx. 2 to 3 mm (5/64 to 1/8 in.) between the tungsten electrode and the workpiece. Gap exists.

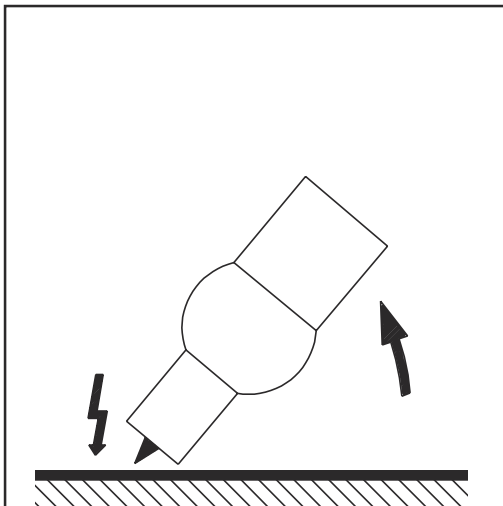

- 2 Increase the tilt angle of the welding torch and actuate the torch trigger according to the mode you have selected

The arc ignites without the electrode touching down on the workpiece.

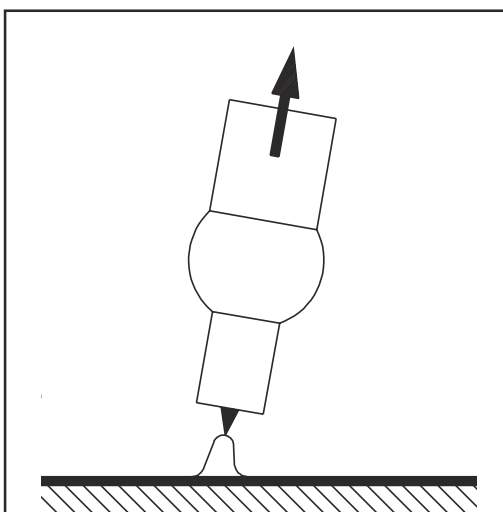

- 3 Tilt the welding torch back into the normal position
- 4 Carry out welding

### Touchdown ignition

If the ignition timeout setup parameter is set to off, HF ignition is deactivated. The welding arc is ignited by touching the workpiece with the tungsten electrode.

Procedure for igniting the arc using touchdown ignition:

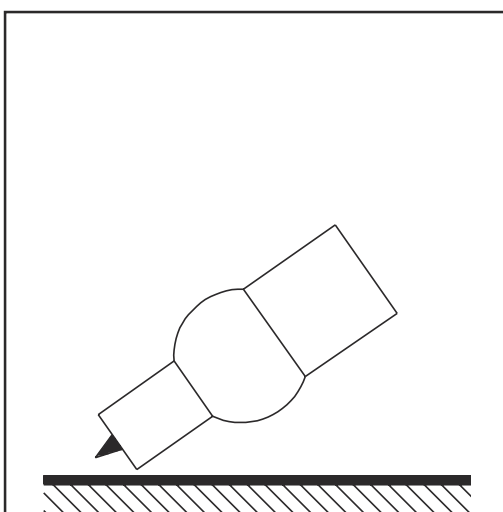

- 1 Place the gas nozzle down on the ignition location, ensuring there is a gap of approx. 2 to 3 mm (5/64 to 1/8 in.) between the tungsten electrode and the workpiece. Gap exists

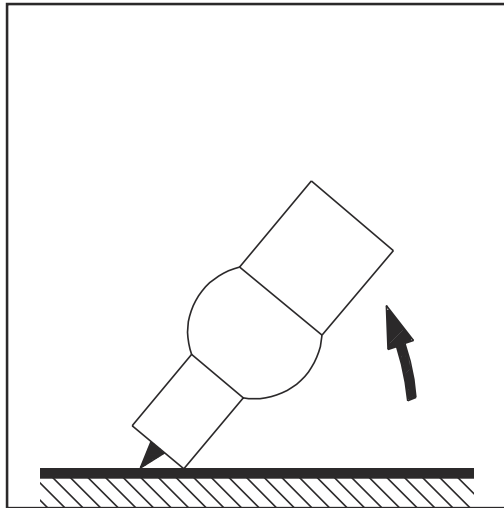

**2** Actuate the torch trigger

shielding gas flows

**3** Gradually tilt the welding torch up until the tungsten electrode touches the workpiece

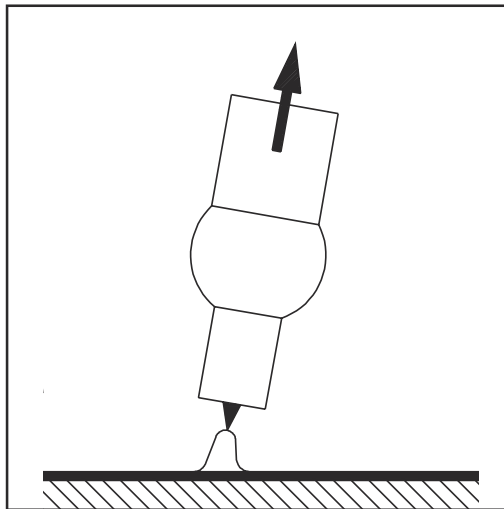

**4** Raise the welding torch and rotate it into its normal position

The arc ignites.

**5** Carry out welding

### Electrode overload

If the tungsten electrode is overloaded, material can detach from the electrode that then contaminates the weld pool.



If the tungsten electrode is overloaded, the "Electrode overload" indicator in the status bar of the control panel lights up.

The "Electrode overload" indicator depends on the electrode diameter and welding current that have been set.

### End of welding

**1** Depending on the set mode, finish welding by releasing the torch trigger

**2** Wait for the set gas post-flow and hold welding torch in position over the end of the weld seam

# TIG special functions

## Ignition timeout function

The power source has an ignition timeout function.

Once the torch trigger is pressed, gas pre-flow begins immediately. Ignition then begins. If an arc does not appear within the time specified in the Setup menu, the power source cuts out automatically.

The settings for the parameter Ignition timeout are described in the section "The HF menu" from page 104 onwards.

## TIG pulsing

The welding current set at the start of welding is not always ideal for the welding process as a whole:

- if the amperage is too low, the base material will not melt sufficiently
- if overheating occurs, the liquid weld pool may drip

The TIG pulsing function (TIG welding with pulsing welding current) offers a remedy: a low base current (2) rises steeply to the significantly higher pulse current and, depending on the set duty cycle (5), drops back to the base current (2).

In TIG pulsing, small sections of the welding location melt quickly and then solidify again quickly.

In manual applications using TIG pulsing, the welding wire is applied in the maximum current phase (only possible in the low frequency range: 0.25 - 5 Hz). Higher pulse frequencies are mainly used in automatic mode to stabilise the arc.

TIG pulsing is used for out-of-position welding of steel pipes or when welding thin sheets.

Mode of operation of TIG pulsing when TIG DC welding is selected:

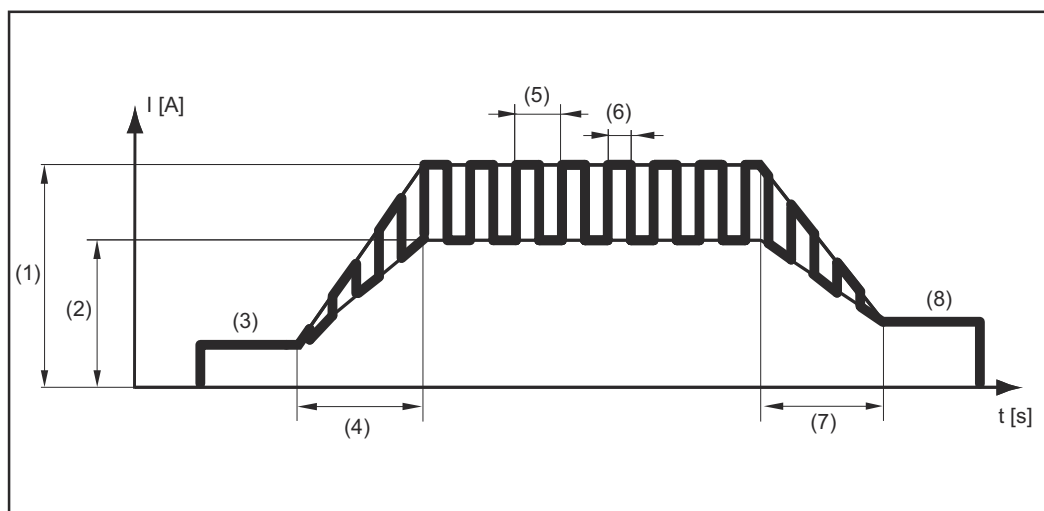

TIG pulsing - welding current curve

Legend:

- (1) Main current, (2) Base current, (3) Starting current, (4) UpSlope, (5) Pulse frequency  
 \*)  
 (6) Duty cycle, (7) DownSlope, (8) Final current

\*)  $(1/F-P = \text{time interval between two pulses})$

## Tacking function

The tacking function is available for the TIG DC welding process.

When a time period is specified for the tacking setup parameter (4), the tacking function is assigned to 2-step mode and 4-step mode. The operating sequence of the modes remains unchanged.

The tacking (TAC) indicator lights up in the status bar on the display:



During this period, there is a pulsed welding current that makes the weld pool run together better when two parts are being tacked.

Mode of operation of tacking function for TIG DC welding:

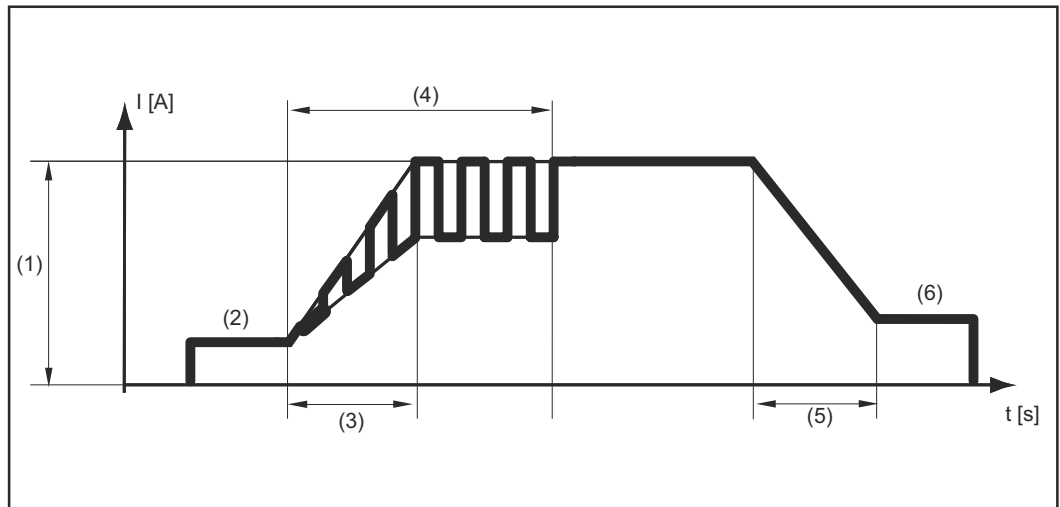

Tacking function - welding current curve

Legend:

(1) Main current, (2) Starting current, (3) UpSlope, (4) Duration of pulsed welding current for tacking, (5) DownSlope, (6) Final current

### NOTE!

#### The following points apply to the pulsed welding current:

The power source automatically regulates the pulsing parameters depending on the set main current (1).

There is no need to set any pulsing parameters.

The pulsed welding current begins

- after the end of the starting-current phase (2)
- with the UpSlope phase (3)

Depending on what tacking period has been set, the pulsed welding current may continue up to and including the final current phase (6) (tacking setup parameter (4) set to "on").

After the tacking time has elapsed, welding continues at a constant welding current, and any pulsing parameters that may have been set continue to be available.



## CycleTIG

The CycleTIG stitch welding process is available for the TIG DC welding process. The welding result is influenced and controlled by different parameter combinations.

The main advantages of CycleTIG are easy control of the weld pool, targeted heat input and fewer temper colours.

### CycleTIG variations

#### CycleTIG + low base current

- For out-of-position welding, edge applications and orbital welding
- Well suited to joins on heavy/light-gauge sheets
- Excellent weld characteristics
- HF ignition only at welding start
- Long electrode service life
- Good control of the weld pool
- Targeted heat input

#### CycleTIG + reversed polarity ignition = on + base current = off

- For repair work (e.g. edge applications)
- Targeted heat input
- Biggest advantage in combination with the HF ignition ignition setting = Touch HF
- HF ignition at every cycle (!)
- Very short electrode service life (!)

Recommendation: iWave AC/DC with the reversed polarity ignition ignition setting = auto

#### CycleTIG + tacking

- For tacking light-gauge sheets, orbital applications and for joins on heavy and light-gauge sheets
- HF ignition only at welding start
- Long electrode service life
- Good control of the weld pool
- Targeted heat input
- Excellent seam appearance
- Tacking function generates automatic pulse setting

#### CycleTIG + pulse

CycleTIG can be used individually with all pulse settings. This allows pulsing in both the high power and low power phases.

- For tacking light-gauge sheets and for cladding applications
- For joins on heavy/light-gauge sheets
- HF ignition only at welding start
- Long electrode service life
- Good control of the weld pool
- Targeted heat input
- Excellent seam appearance
- Individual pulse settings possible
- More parameters to set

# Manual metal arc welding, CEL welding

## Safety

### **WARNING!**

#### **Danger from incorrect operation and work that is not carried out properly.**

This can result in serious personal injury and damage to property.

- ▶ All the work and functions described in this document must only be carried out by technically trained and qualified personnel.
- ▶ Read and understand this document in full.
- ▶ Read and understand all safety rules and user documentation for this device and all system components.

### **WARNING!**

#### **Danger from electrical current.**

This can result in serious personal injury and damage to property.

- ▶ Before starting work, switch off all devices and components involved and disconnect them from the grid.
- ▶ Secure all devices and components involved so they cannot be switched back on.
- ▶ After opening the device, use a suitable measuring instrument to check that electrically charged components (such as capacitors) have been discharged.

## Preparation

- 1 Move the mains switch to the "O" position
- 2 Disconnect the mains plug
- 3 Remove the TIG welding torch

**IMPORTANT!** Observe the instructions on the packaging of the rod electrode when selecting the appropriate type of current and for correctly connecting the electrode cable and grounding cable.

- 4 Plug in and latch the grounding cable:  
in the (+) current socket ... for DC- welding (=/-)  
in the (-) current socket ... for DC+ welding (=/+)
- 5 Use the other end of the grounding cable to establish a connection to the workpiece
- 6 Plug in the electrode cable and turn it clockwise to latch it in place:  
in the (-) current socket ... for DC- welding (=/-)  
in the (+) current socket ... for DC+ welding (=/+)
- 7 Plug in the mains plug

### **CAUTION!**

#### **Risk of injury and damage to property from electric shock.**

As soon as the mains switch is in the "I" position, the rod electrode in the electrode holder is live.

- ▶ Make sure the rod electrode does not touch any persons or electrically conductive or earthed parts (e.g. the housing, etc.).

- 8 Move the mains switch to the "I" position

The Fronius logo appears on the display.

## Manual metal arc welding, CEL welding

- 1 Press the Mode button



The welding processes and operating modes are displayed.

- 2 Select the electrode (Stick / MMA) or CEL welding process (turn and press the adjusting dial)

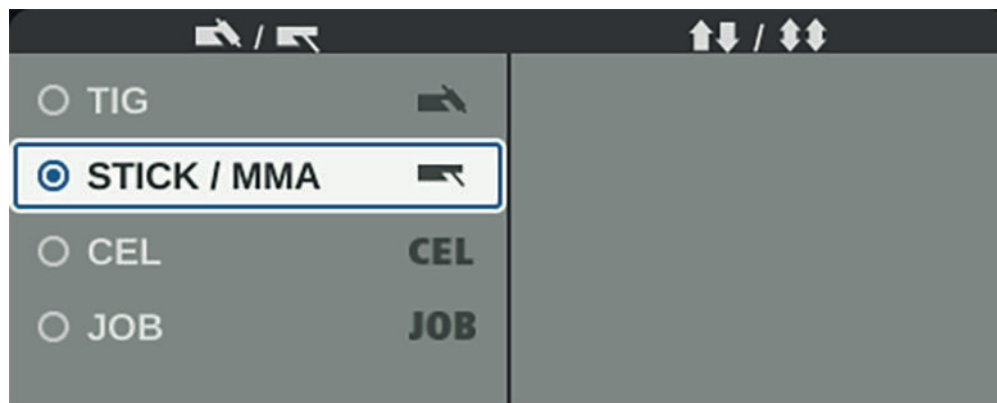

If the MMA welding process is selected, any cooling unit present is automatically deactivated. It is not possible to switch it on.

- 3 Turn the adjusting dial to select the Polarity parameter:  
DC- / DC+ / AC ... during MMA welding  
DC- / DC+ ... during MMA welding with cellulose electrodes
- 4 Press the adjusting dial
- 5 Set the polarity for the rod electrodes to be used by turning the adjusting dial
- 6 Confirm the selection by pressing the adjusting dial
- 7 Turn the adjusting dial to select further welding parameters
- 8 Press the adjusting dial

The value of the parameter is highlighted in blue and can now be changed.

- 9 Turn the adjusting dial: change the value of the parameter
- 10 Press the adjusting dial
- 11 If required, set further parameters in the Setup menu  
(For details, see the "Setup settings" chapter, starting on page 87)

### NOTE!

**All welding parameter set values that have been set using the adjusting dial remain stored until the next time they are changed.**

This applies even if the power source was switched off and on again in the interim.

- 12 Start welding

**Welding parameters for manual metal arc welding**

\* Depending on the selected current type, (+), (-) or the alternating current symbol is displayed here.

xxA = actual current value depending on the specified main current

**Starting current**

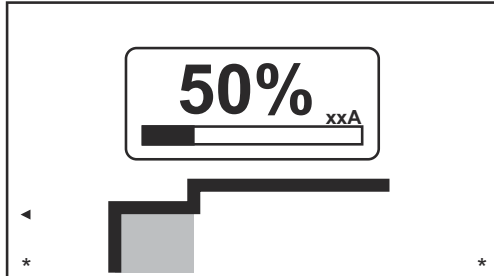

Starting current: starting current < main current ("SoftStart")

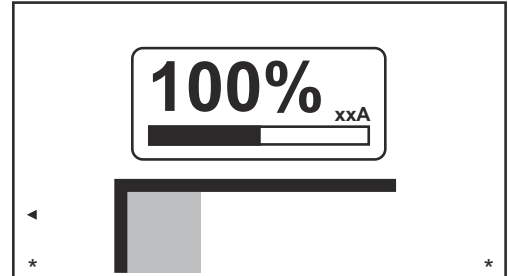

Starting current: starting current = main current

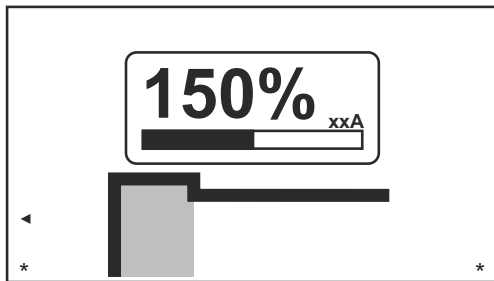

Starting current: starting current > main current ("HotStart")

Setting range: 0 - 200% (of main current)  
Factory setting: 150%

**Main current**

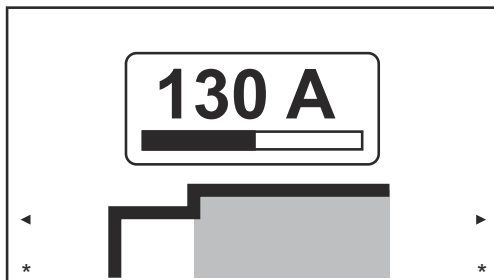

Main current: starting current < main current ("Soft-Start")

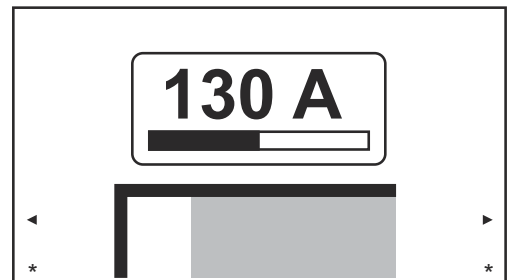

Main current: starting current = main current

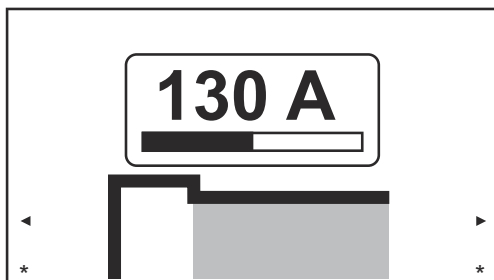

Main current: starting current > main current ("HotStart")

Setting range: 0 - 190 A ... iWave 190i, 0 - 230 A ... iWave 230i  
Factory setting:-

## Arc-force dynamic

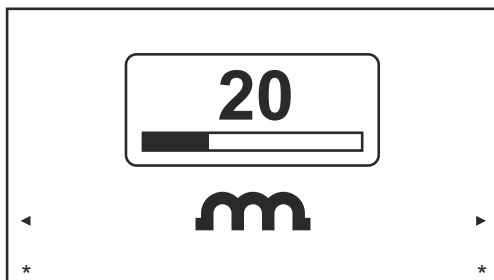

To obtain optimum welding results, it will sometimes be necessary to adjust the arc-force dynamic.

Setting range: 0 - 100% (of main current)

Factory setting: 20

0 ... soft and low-spatter arc

100 ... harder and more stable arc

Functional principle:

At the instant of droplet transfer or in the event of a short circuit, there is a momentary rise in amperage. In order to obtain a stable arc, the welding current is temporarily increased. If the rod electrode threatens to sink into the weld pool, this measure prevents the weld pool solidifying, as well as preventing more prolonged short circuiting of the arc. This largely prevents the rod electrode from sticking.

## Polarity

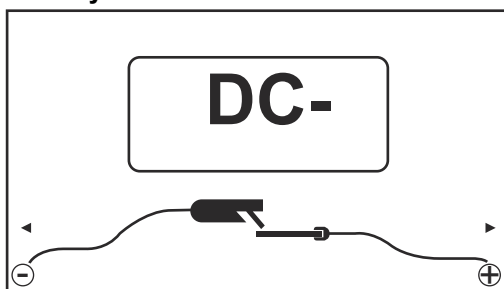

*Polarity, set to DC-*

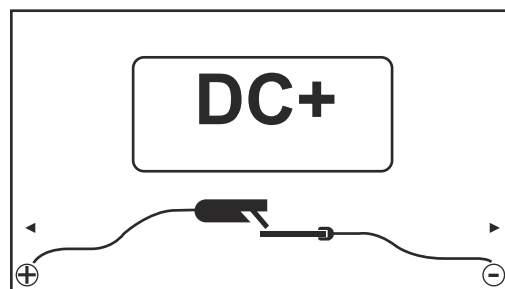

*Polarity, set to DC+*

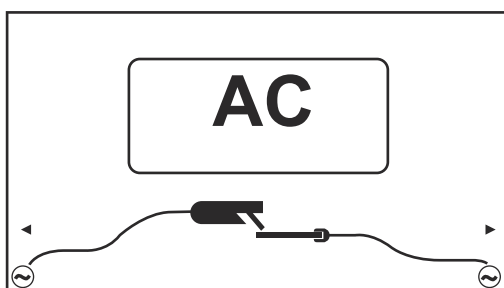

*Polarity, set to AC*

Setting range: DC- / DC+ / AC

Factory setting: DC-

## Welding parameters for MMA welding with cellulose electrodes

\* Depending on the selected current type, (+) or (-) is displayed here.

xxA = actual current value depending on the specified main current

### Starting current

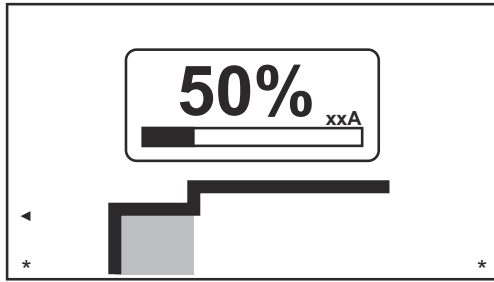

Starting current: starting current < main current ("SoftStart")

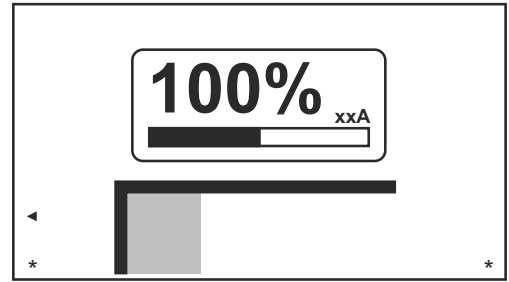

Starting current: starting current = main current

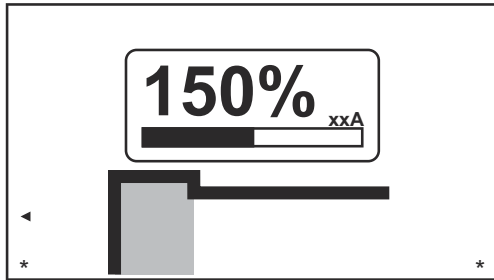

Starting current: starting current > main current ("HotStart")

Setting range: 0 - 200% (of main current)  
Factory setting: 150%

### Main current

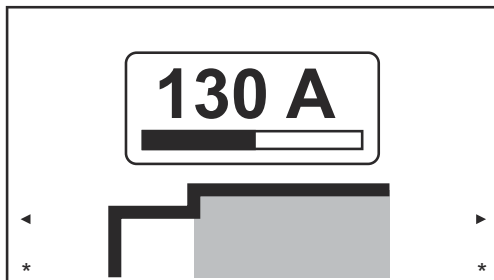

Main current: starting current < main current ("Soft-Start")

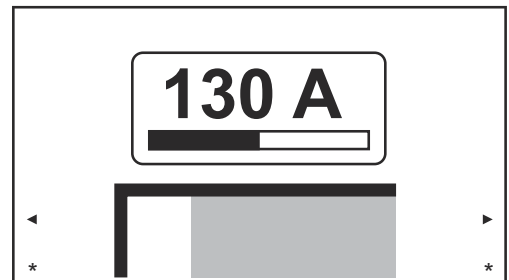

Main current: starting current = main current

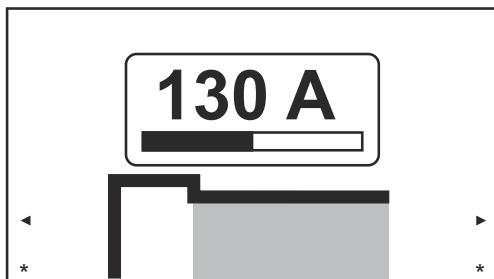

Main current: starting current > main current ("HotStart")

Setting range: 0 - 190 A ... iWave 190i, 0 - 230 A ... iWave 230i  
Factory setting: -

### Arc-force dynamic

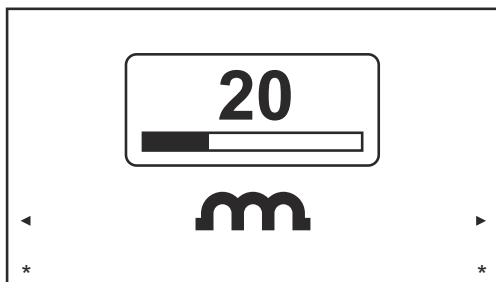

To obtain optimum welding results, it will sometimes be necessary to adjust the arc-force dynamic.

Setting range: 0 - 100% (of main current)

Factory setting: 20

0 ... soft and low-spatter arc

100 ... harder and more stable arc

Functional principle:

At the instant of droplet transfer or in the event of a short circuit, there is a momentary rise in amperage. In order to obtain a stable arc, the welding current is temporarily increased. If the rod electrode threatens to sink into the weld pool, this measure prevents the weld pool solidifying, as well as preventing more prolonged short circuiting of the arc. This largely prevents the rod electrode from sticking.

### Polarity

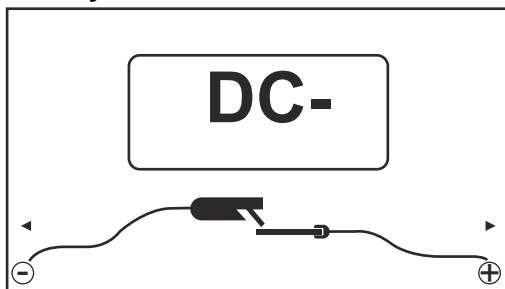

*Polarity, set to DC-*

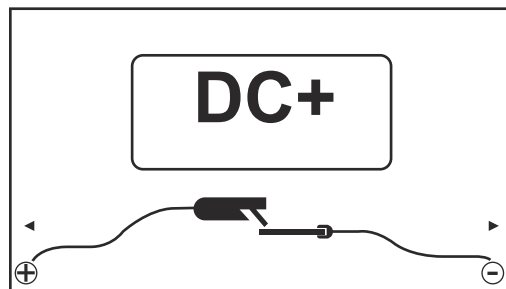

*Polarity, set to DC+*

Setting range: DC- / DC+

Factory setting: DC-

**Starting current > 100 % (Hot-Start)**

**Advantages**

- Improved ignition properties, even when using electrodes with poor ignition properties
- Better fusion of the base material in the start-up phase, meaning fewer cold-shut defects
- Largely prevents slag inclusions

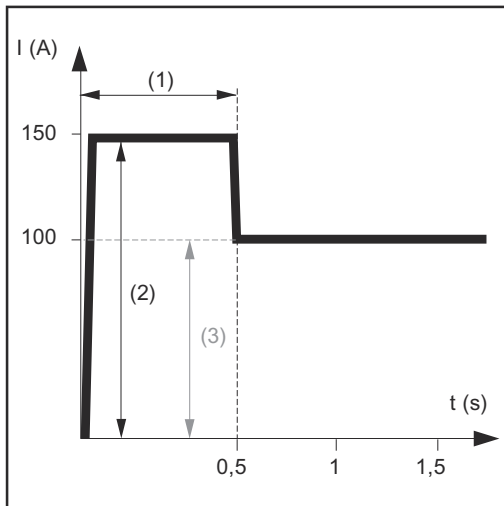

Example with a starting current > 100% (HotStart)

- (1) Starting current time  
0-2 s, factory setting 0.5 s
- (2) Starting current  
0-200%, factory setting 150%
- (3) Main current = pre-set welding current  $I_1$

**Mode of operation**

during the specified starting current time (1), the welding current  $I_1$  (3) is increased to the starting current (2).

The starting current time is set in the Setup menu.

**Starting current < 100 % (SoftStart)**

A starting current < 100% (SoftStart) is intended for basic electrodes. Ignition takes place at a low welding current. Once the arc is stable, the welding current continues to rise until it reaches the welding current command value.

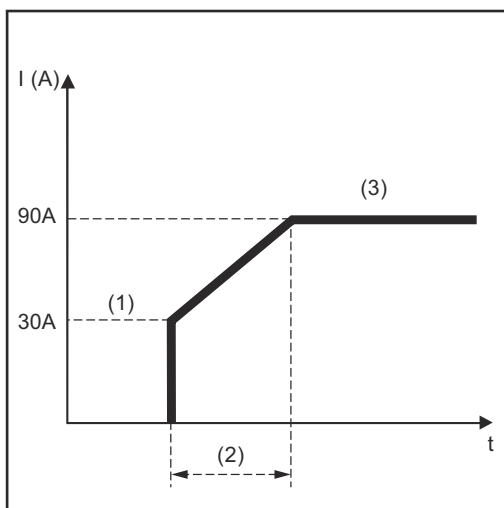

Example with a starting current < 100% (SoftStart)

**Benefits:**

- Improved ignition properties for electrodes that ignite at low welding currents
- Largely prevents slag inclusions
- Reduces welding spatter

- (1) Starting current
- (2) Starting current time
- (3) Main current

The starting current time is set in the rod electrodes menu.



---

**Anti-stick function**

As the arc becomes shorter, the welding voltage may drop so far that the rod electrode will tend to stick. This may also cause the rod electrode to burn out.

Electrode burn-out is prevented by activating the anti-stick function. If the rod electrode begins to stick, the power source immediately switches the welding current off. After the rod electrode has been detached from the workpiece, the welding process can be continued without any problems.

The anti-stick function can be activated and deactivated in the rod electrodes menu.

# EasyJob mode

## Storing EasyJob operating points

### NOTE!

The EasyJobs are stored under job numbers 1 - 5 and can also be retrieved from the Job menu.

Storing an EasyJob overwrites any other job saved under the same number!

Prerequisite:

EasyJobs must be assigned to the Favourites button (see "Assigning EasyJobs to the Favourites button", starting on page 30).

- 1 Set the welding process, mode and welding parameters
- 2 Press the Favourites button

The 5 EasyJob buttons are opened.

- 3 Turn the adjusting dial and select the desired storage location



- 4 To save the current welding settings, press and hold the adjusting dial for about 3 seconds

The size and colour of the button changes.



After about 3 seconds, the button is displayed in green.



The settings have now been stored. The most recently stored settings will be active. An active EasyJob is indicated by a flag on the EasyJob button.



An occupied storage location is displayed in black, e.g.:

Storage location 1 ... occupied and active

Storage location 2 ... selected

Storage location 3 ... free

Storage location 4 ... free

Storage location 5 ... free



### Retrieving EasyJob operating points

- 1 Press the Favourites button

The 5 EasyJob buttons are opened.

- 2 Turn the adjusting dial and select the desired storage location



- 3 To retrieve a saved EasyJob operating point, press the adjusting dial briefly (< 3 seconds)

The size and colour of the button changes.

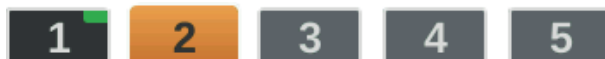

The EasyJob buttons are then minimised and the active EasyJob is indicated by a flag.



### Deleting EasyJob operating points

- 1 Press the Favourites button

The 5 EasyJob buttons are opened.

- 2 Turn the adjusting dial and select the storage location to be deleted



- 3 To delete an EasyJob operating point, press and hold the adjusting dial for about 5 seconds

The button

- first changes its size and colour;
- it changes to a green colour after about 3 seconds;  
The saved operating point is overwritten with the current settings.
- is highlighted in red (= delete) after a total of 5 seconds.



The EasyJob operating point has been deleted.

# Welding job

---

## Safety



### WARNING!

#### **Danger from incorrect operation and work that is not carried out properly.**

This can result in serious personal injury and damage to property.

- ▶ All the work and functions described in this document must only be carried out by technically trained and qualified personnel.
  - ▶ Read and understand this document in full.
  - ▶ Read and understand all safety rules and user documentation for this device and all system components.
- 



### WARNING!

#### **Danger from electrical current.**

This can result in serious personal injury and damage to property.

- ▶ Before starting work, switch off all devices and components involved and disconnect them from the grid.
  - ▶ Secure all devices and components involved so they cannot be switched back on.
  - ▶ After opening the device, use a suitable measuring instrument to check that electrically charged components (such as capacitors) have been discharged.
- 

## Preparation

- 1 Set up and install the power source in accordance with the welding job
- 2 Plug in the mains plug



### CAUTION!

#### **Risk of injury and damage to property from electric shock.**

As soon as the mains switch is in the "I" position, the tungsten electrode of the welding torch is live.

- ▶ Ensure that the tungsten electrode does not touch any persons or electrically conductive or earthed parts (e.g. housing, etc.).
- 

- 3 Move the mains switch to the "I" position

## Welding a job

- 1 Press the Mode button



The welding processes and operating modes are displayed.

- 2 Select "JOB" (turn adjusting dial and press)

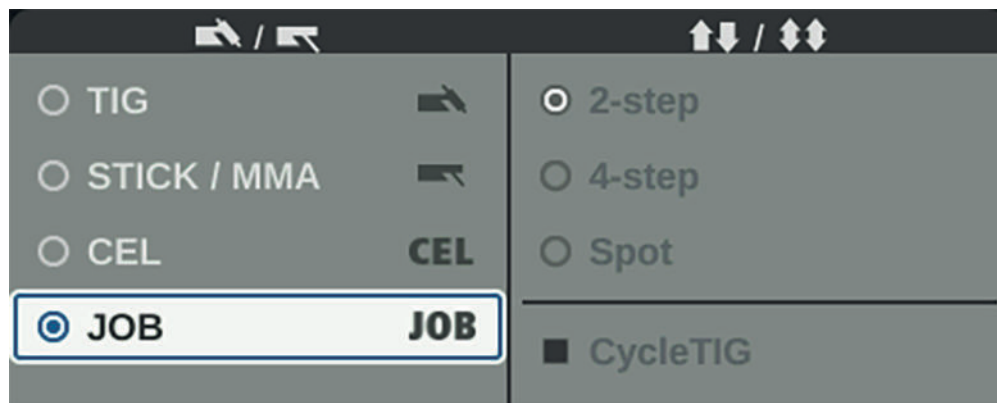

The welding parameters of the previously opened job are displayed after a short time. The job number is selected.

- 3 Press the adjusting dial

The job number can now be modified.

- 4 Select the job number of the welding job (turn adjusting dial and press)

The welding parameters of the selected job are displayed and the job can now be welded.



# Setup settings





# The Setup menu

## General

The Setup menu provides easy access to the knowledge base in the power source and to additional functions. The Setup menu can be used to make simple adjustments to the welding parameters to suit the various job settings.

The following can be found in the Setup menu:

- all setup parameters that have an immediate effect on the welding process,
- all setup parameters needed for making the preliminary settings on the welding system.

The display of the parameters and the ability to change them depends on the selected menu and the current settings for the welding process and operating mode. Parameters that are not relevant to the current settings are greyed out and cannot be selected.

## Accessing the Setup menu



- 1 Press Menu key

The Setup menu appears.

- 2 To leave the Setup menu, press the Menu key again

The current welding parameters will be displayed.

## Overview

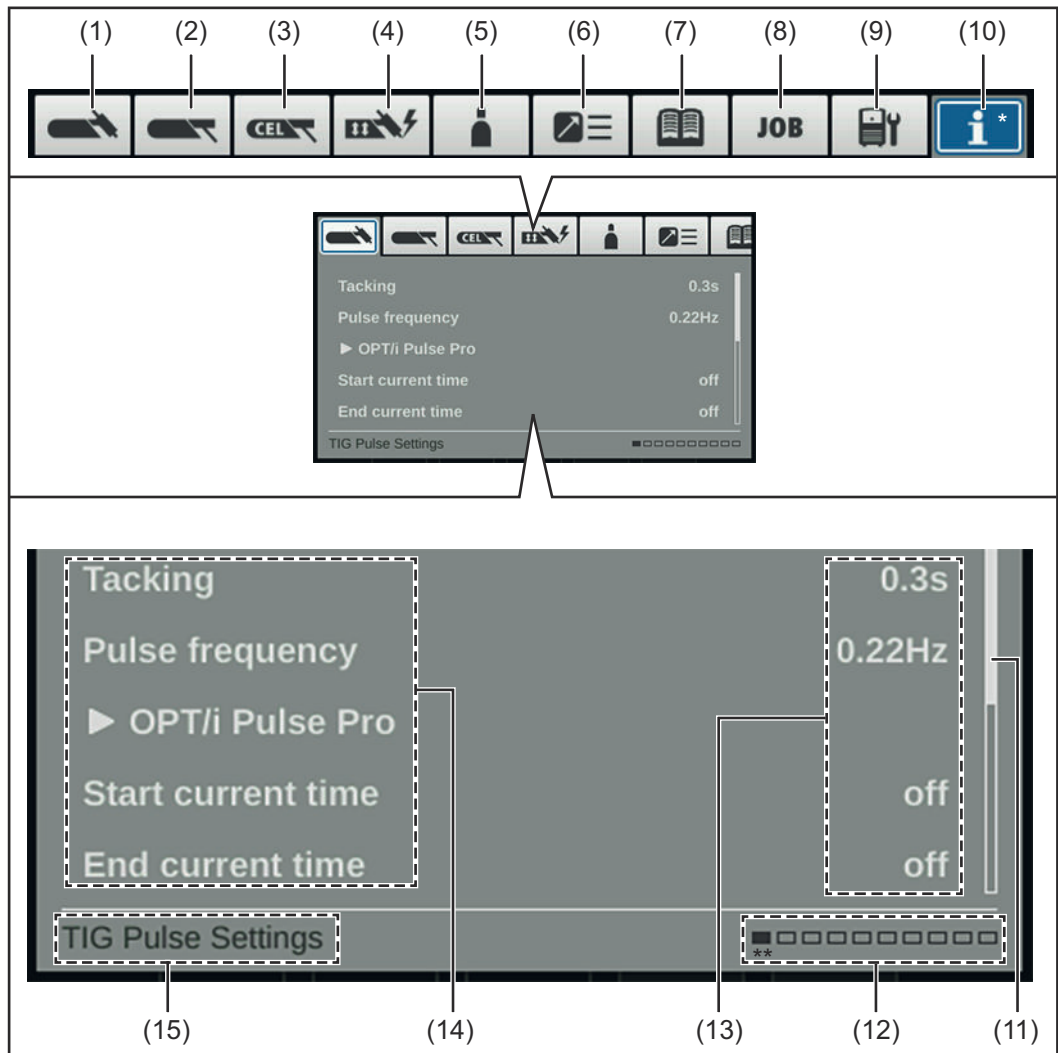

Item	Description
(1)	<b>TIG menu</b> for setting the TIG parameters for TIG DC and TIG AC
(2)	<b>Rod electrode menu</b> for setting rod electrode parameters
(3)	<b>CEL menu</b> for setting the parameters for manual metal arc welding with cellulose electrodes
(4)	<b>Ignition and mode settings</b> for setting the <ul style="list-style-type: none"> <li>- Ignition parameters</li> <li>- Arc monitoring</li> <li>- Operating mode defaults</li> </ul>
(5)	<b>Gas menu</b> for setting the shielding gas parameters
(6)	<b>Component settings</b> for setting the cooling unit mode
(7)	<b>Documentation menu</b> (only with OPT/i documentation option present)

- to display welds, events, logbook
- for setting the sampling rate and limit value monitoring

---

**(8) Job menu**

(only if OPT/i Jobs function package is present)

- to save, load and delete jobs
- to assign EasyJobs to the Favourites button

---

**(9) Defaults**

for setting the

- display (backlighting, languages, date & time, etc.)
- system (power source configuration, factory setting, etc.)
- network settings (Bluetooth, network setup, WLAN, etc.)
- user management (create user, create role, etc.)
- management (trial license)

For a detailed overview of the defaults, see page [122](#).

---

**(10) System information**

to view device information such as software version or IP address (if power source is integrated into a network)

---

**(11) Scroll bar**

(if there are several parameters)

---

**(12) Available menus**

The number of menus available may vary depending on the firmware version and available options.

---

**(13) Value, unit**

---

**(14) Setup parameters**

Depending on the selected menu and the current settings for the welding process and operating mode, parameters that are not relevant are greyed out and cannot be selected.

---

**(15) Indication of the currently selected menu**

Taking into account the current settings for welding process and operating mode

\* Menu currently being adjusted (blue background)

\*\* Position of the currently selected menu

---

**Changing menus and parameters**



*Selected menu*



*Change the menu*

Start current time 0.30s

*Selected parameter*

Start current time 0.30s

*Set the parameter*

### **Selecting a menu**

If a parameter is selected (blue frame, white background):

- 1** Turn the adjusting dial until the parameter's higher-level menu is selected
- 2** Press the adjusting dial

The background of the selected menu becomes blue.

- 3** Turn the adjusting dial and select the desired menu (blue background)

### **Setting parameters**

- 4** Press the adjusting dial in the selected menu

The first parameter in the menu is selected.

- 5** Turn the adjusting dial and select the desired parameter

- 6** Press the adjusting dial to change the parameter

The background of the parameter value becomes blue.

- 7** Turn the adjusting dial and set the value of the parameter

The change in the parameter value takes effect immediately

- 8** Press the adjusting dial to select other parameters

# The TIG menu

## Parameters in the TIG DC menu

### Tacking

Tacking function – duration of the pulsed welding current at the start of tacking

off / 0.1 - 9.9 s / on

Factory setting: off

on

The pulsed welding current remains until the end of the tacking process

0.1 - 9.9 s

The set time begins with the UpSlope phase. After the set time has elapsed, welding is continued with a constant welding current; the pulse parameters, if any, are available

off

Tacking function switched off



The tacking indicator (TAC) in the status bar on the display lights up provided that a value has been set.

### Pulse frequency

off / 0.20 - 2000 Hz (10,000 Hz with FP Pulse Pro option)

Factory setting: off

**IMPORTANT!** If the pulse frequency is set to "off", the Base current and Duty cycle parameters cannot be selected.

The set pulse frequency is also used for the reduced current.



The pulse indicator in the status bar on the display lights up provided a value has been specified for the pulse frequency.

### OPT/i Pulse Pro

For setting the base current, duty cycle, pulse waveform and base current waveform parameters

#### Base current

0 - 100% (of main current  $I_1$ )

Factory setting: 50%

#### Duty cycle

Ratio of pulse duration to base current duration in cases where a pulse frequency has been set

10 - 90%

Factory setting: 50%

### **Pulse waveform**

To optimise the arc pressure

Hard rectangle / Soft rectangle / Sine  
Factory setting: Hard rectangle

Hard rectangle:  
Pure rectangular waveform;  
slightly louder arc noise. Rapid current changes  
Used for orbital welding, for example

Soft rectangle:  
Rectangular waveform with decreased edge steepness, for noise reduction compared to the pure rectangular waveform;  
universal applications

Sine:  
Sinusoidal waveform (default setting for low noise and stable arc);  
used for corner seams and cladding applications, for example

Optimising the arc pressure has the following effects:

- Better wetting of the weld pool (improved welding of butt welds or corner welds)
- Slow current rise or current drop (especially with fillet welds, high-alloy steels or cladding applications, the filler material or the weld pool is not pushed away)
- Quieter welding thanks to smoother waveforms

---

### **Base current waveform**

To optimise the arc pressure

Hard rectangle / Soft rectangle / Sine  
Factory setting: Hard rectangle

Hard rectangle:  
Pure rectangular waveform;  
slightly louder arc noise. Rapid current changes  
Used for orbital welding, for example

Soft rectangle:  
Rectangular waveform with decreased edge steepness, for noise reduction compared to the pure rectangular waveform;  
universal applications

Sine:  
Sinusoidal waveform (default setting for low noise and stable arc);  
used for corner seams and cladding applications, for example

---

### **Starting current time**

The starting current time specifies the duration of the starting-current phase.

off / 0.01 - 30.0 s  
Factory setting: off

**IMPORTANT!** The starting current time only applies to 2-step mode and spot welding. In 4-step mode, the duration of the starting-current phase is controlled using the torch trigger.

---

### **Final current time**

The final current time specifies the duration of the final current phase.

off / 0.01 - 30 s  
Factory setting: off

**IMPORTANT!** The final current time only applies to 2-step mode and spot welding. In 4-step mode, the duration of the final current phase is controlled using the torch trigger (see "TIG operating modes").

---

### **Slope reduced current**

To set the Slope1 reduced current and Slope2 reduced current parameters

---

#### **Slope1 reduced current**

off / 0.01 - 30 s  
Factory setting: off

If a time value has been entered for the Slope1 reduced current parameter, the short-term current reduction or current increase is not abrupt, but rather slow and adapted to the desired current curve.

This reduces negative effects on the weld seam and component, especially for aluminium applications.

---

#### **Slope2 reduced current**

off / 0.01 - 30 s  
Factory setting: off

If a time value has been entered for the Slope2 reduced current parameter, the adaptation of the reduced current to the welding current is not abrupt, but rather slow and adapted to the desired current curve.

For example, during a current increase, the weld pool is heated slowly, not abruptly. This allows the weld pool to outgas and reduces pores during aluminium welding.

---

#### **Spot welding time** (spot welding mode only)

0.02 - 120 s  
Factory setting: 5.0 s

---

---

## Parameters in the TIG AC menu

---

### Pulse frequency

off / 0.20 - 2000 Hz (10,000 Hz with FP Pulse Pro option)  
Factory setting: off

**IMPORTANT!** If the pulse frequency is set to "off", the Base current and Duty cycle parameters cannot be selected.

The set pulse frequency is also used for the reduced current.



The pulse indicator in the status bar on the display lights up provided a value has been specified for the pulse frequency.

---

### OPT/i Pulse Pro

For setting the base current, duty cycle, pulse waveform and base current waveform parameters

---

#### Base current

0 - 100% (of main current  $I_1$ )  
Factory setting: 50%

---

#### Duty cycle

Ratio of pulse duration to base current duration in cases where a pulse frequency has been set

10 - 90%  
Factory setting: 50%

---

#### Pulse waveform

To optimise the arc pressure

Hard rectangle / Soft rectangle / Sine  
Factory setting: Hard rectangle

Hard rectangle:  
Pure rectangular waveform;  
slightly louder arc noise. Rapid current changes  
Used for orbital welding, for example

Soft rectangle:  
Rectangular waveform with decreased edge steepness, for noise reduction compared to the pure rectangular waveform;  
universal applications

Sine:  
Sinusoidal waveform (default setting for low noise and stable arc);  
used for corner seams and cladding applications, for example

Optimising the arc pressure has the following effects:

- Better wetting of the weld pool (improved welding of butt welds or corner welds)
  - Slow current rise or current drop (especially with fillet welds, high-alloy steels or cladding applications, the filler material or the weld pool is not pushed away)
  - Quieter welding thanks to smoother waveforms
-



**Base current waveform**

To optimise the arc pressure

Hard rectangle / Soft rectangle / Sine

Factory setting: Hard rectangle

Hard rectangle:

Pure rectangular waveform;

slightly louder arc noise. Rapid current changes

Used for orbital welding, for example

Soft rectangle:

Rectangular waveform with decreased edge steepness, for noise reduction compared to the pure rectangular waveform;

universal applications

Sine:

Sinusoidal waveform (default setting for low noise and stable arc);

used for corner seams and cladding applications, for example

**Starting current time**

(only in 2-step mode and during spot welding)

The starting current time specifies the duration of the starting-current phase.

off / 0.01 - 30.0 s

Factory setting: off

**IMPORTANT!** The starting current time only applies to 2-step mode and spot welding. In 4-step mode, the duration of the starting-current phase is controlled using the torch trigger.

**Final current time**

(only in 2-step mode and during spot welding)

The final current time specifies the duration of the final current phase.

off / 0.01 - 30 s

Factory setting: off

**IMPORTANT!** The final current time only applies to 2-step mode and spot welding. In 4-step mode, the duration of the final current phase is controlled using the torch trigger (see "TIG operating modes").

**Slope reduced current**

To set the Slope1 reduced current and Slope2 reduced current parameters

**Slope1 reduced current**

off / 0.01 - 30 s

Factory setting: off

If a time value has been entered for the Slope1 reduced current parameter, the short-term current reduction or current increase is not abrupt, but rather slow and adapted to the desired current curve.

This reduces negative effects on the weld seam and component, especially for aluminium applications.

**Slope2 reduced current**

off / 0.01 - 30 s

Factory setting: off

If a time value has been entered for the Slope2 reduced current parameter, the adaptation of the reduced current to the welding current is not abrupt, but rather slow and adapted to the desired current curve.

For example, during a current increase, the weld pool is heated slowly, not abruptly. This allows the weld pool to outgas and reduces pores during aluminium welding.

---

### Spot welding time

(spot welding mode only)

0.02 - 120 s

Factory setting: 5.0 s

---

### AC frequency

Syn / 40 - 250 Hz

Factory setting: 60 Hz

Syn

Setting for synchronous welding (both-sided, simultaneous welding with 2 power sources)

For synchronous welding, the AC frequency must be set to "Syn" on both power sources. Synchronous welding is used for thick material thicknesses to achieve a high deposition rate and to minimise inclusions during welding.

**IMPORTANT!** Owing to the phasing of the input voltage, in some cases the synchronisation of the two power sources cannot be carried out properly.

In this case, pull out the mains plug of the power source, turn it through 180° and plug it back in again.

Low frequency

soft, wide arc with shallow heat input

High frequency

focused arc with deep heat input

Effect of the AC frequency on the waveshape:

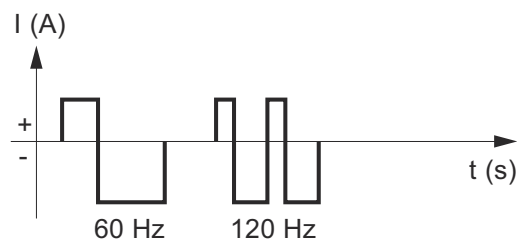

---

### AC current offset

-70 to +70%

Factory setting: 0%

+70%

Wide arc with low heat input

High stress on the tungsten electrode

Good surface cleaning

-70%

Narrow arc with high heat input

Less stress on the tungsten electrode

Very little surface cleaning

Effect of the AC current offset on the waveshape:

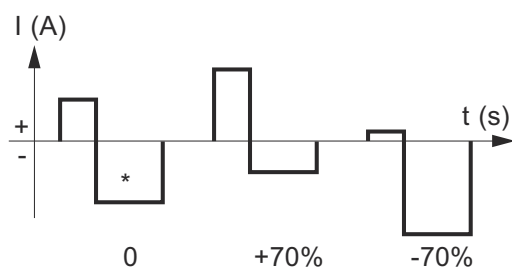

\* Factory setting: 0 (corresponds to a 10% shift to negative)

---

### Positive half-wave waveform

Hard rectangle / Soft rectangle / Triangle / Sine

Factory setting: Sine

Hard rectangle

pure rectangular waveform (stable but loud arc)

Soft rectangle

rectangular waveform with decreased edge steepness, for noise reduction compared to the pure rectangular waveform

Triangle

increased current peaks for more arc pressure

Sine

default setting for low noise arc

---

### Negative half-wave waveform

Hard rectangle / Soft rectangle / Triangle / Sine

Factory setting: Soft rectangle

Hard rectangle

pure rectangular waveform (stable but loud arc)

Soft rectangle

rectangular waveform with decreased edge steepness, for noise reduction compared to the pure rectangular waveform

Triangle

increased current peaks for more arc pressure

Sine

default setting for low noise and stable arc

---

# The MMA menu

## Parameters in the rod electrode menu

### Starting current time

HotStart

0.0 - 2.0 s

Factory setting: 0.5 s

To obtain optimum welding results, it will sometimes be necessary to adjust the HotStart function.

Benefits:

- Improved ignition properties, even when using electrodes with poor ignition properties
- Better fusion of the base material in the start-up phase, meaning fewer cold-shut defects
- Largely prevents slag inclusions

### Char

To select characteristics

I-constant / 0.1 - 20.0 A/V / P-constant

Factory setting: I-constant

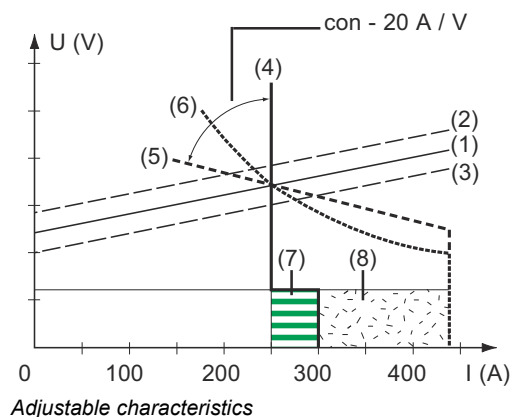

- (1) Load line for rod electrode
- (2) Load line for rod electrode where arc length is increased
- (3) Load line for rod electrode where arc length is reduced
- (4) Characteristic for parameter setting I-constant (constant welding current)
- (5) Characteristic for parameter setting 0.1 - 20.0 (drooping characteristic with adjustable slope)
- (6) Characteristic for parameter setting P-constant (constant welding power)

- (7) Example of pre-set arc-force dynamic where characteristic (4) is selected
- (8) Example of pre-set arc-force dynamic where characteristic (5) or (6) is selected

### I-constant (constant welding current)

- If the I-constant characteristic is set, the welding current will be kept constant, irrespective of the welding voltage. This results in a vertical characteristic (4).
- The setting is particularly suitable for rutile electrodes, basic electrodes, gouging (set the dynamic to 100 for gouging).

### 0.1 - 20.0 A/V (drooping characteristic with adjustable slope)

- Setting 0.1 - 20.0 is used to set a drooping characteristic (5). The setting range is from 0.1 A/V (very steep) to 20 A/V (very flat).
- Setting a flat characteristic (5) is only advisable for cellulose electrodes.

**NOTE!**

When setting a flat characteristic (5), set the arc-force dynamic to a higher value.

**P-constant (constant welding power)**

- If the P-constant characteristic is set, the welding power is kept constant, irrespective of the welding voltage and welding current. This results in a hyperbolic characteristic (6).
- This setting is particularly suitable for cellulose electrodes.

**NOTE!**

If there are problems with a rod electrode tending to "stick", set the arc-force dynamic to a higher value.

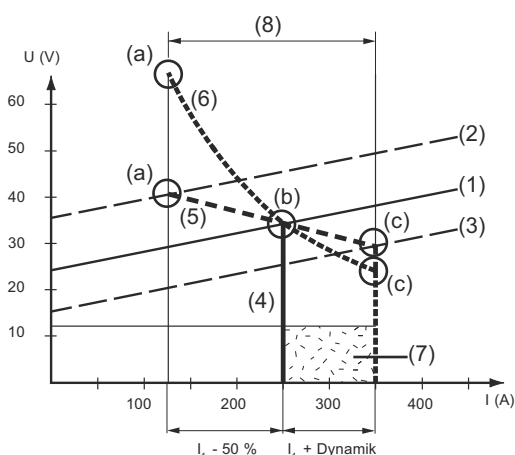

Settings example:  $I_1 = 250 \text{ A}$ , arc-force dynamic = 50

- (1) Load line for rod electrode
- (2) Load line for rod electrode where arc length is increased
- (3) Load line for rod electrode where arc length is reduced
- (4) Characteristic for parameter setting I-constant (constant welding current)
- (5) Characteristic for parameter setting 0.1 - 20.0 (drooping characteristic with adjustable slope)
- (6) Characteristic for parameter setting P-constant (constant welding power)

- (7) Example of pre-set arc-force dynamic where characteristic (4) is selected
- (8) Example of pre-set arc-force dynamic where characteristic (5) or (6) is selected

- (a) Operating point where arc length is long
- (b) Operating point when welding current  $I_1$  is set
- (c) Operating point where arc length is short

The characteristics (4), (5) and (6) shown here apply when using a rod electrode whose characteristic corresponds to the load line (1) at a given arc length.

Depending on what welding current ( $I$ ) has been set, the point of intersection (operating point) of characteristics (4), (5) and (6) will be displaced along the load line (1). The operating point provides information on the actual welding voltage and the actual welding current.

Where the welding current ( $I_1$ ) is permanently set, the operating point may migrate along the characteristics (4), (5) and (6) depending on the welding voltage at that moment in time.

The welding voltage  $U$  is dependent upon the arc length.

If the arc length changes (e.g. in accordance with the load line (2)) the resulting operating point will be the point where the corresponding characteristic (4), (5) or (6) intersects with the load line (2).

For characteristics (5) and (6), if a constant value is set for  $I_1$ , the welding current ( $I$ ) will also become smaller or larger depending on the welding voltage.

---

**Break-voltage**

Welding voltage limitation

20 - 90 V

Factory setting: 20 V

The arc length depends on the welding voltage. To end the welding process, it is usually necessary to significantly lift the rod electrode away from the workpiece. With this parameter, the welding voltage can be limited to a value that makes it possible to end the welding operation simply by slightly lifting the rod electrode.

**NOTE!**

**If, during welding, you often find that the welding operation is ended unintentionally, increase the value of the break-voltage parameter.**

---

**Anti-stick**

on / off

Factory setting: on

As the arc becomes shorter, the welding voltage may drop so far that the rod electrode will tend to stick. This may also cause the rod electrode to burn out.

Electrode burn-out is prevented by activating the anti-stick function. If the rod electrode begins to stick, the power source immediately switches the welding current off. After the rod electrode has been detached from the workpiece, the welding process can be continued without any problems.

---

**AC frequency**

only for MMA AC welding (welding parameter polarity = AC)

40 - 250 Hz

Factory setting: 60 Hz

---

# The CEL menu

---

## Parameters in the CEL menu

---

### Starting current time

HotStart

0.0 - 2.0 s

Factory setting: 0.5 s

To obtain optimum welding results, it will sometimes be necessary to adjust the HotStart function.

Benefits:

- Improved ignition properties, even when using electrodes with poor ignition properties
  - Better fusion of the base material in the start-up phase, meaning fewer cold-shut defects
  - Largely prevents slag inclusions
- 

### Break-voltage

Welding voltage limitation

20 - 90 V

Factory setting: 20 V

The arc length depends on the welding voltage. To end the welding process, it is usually necessary to significantly lift the rod electrode away from the workpiece. With this parameter, the welding voltage can be limited to a value that makes it possible to end the welding operation simply by slightly lifting the rod electrode.

### **NOTE!**

**If, during welding, you often find that the welding operation is ended unintentionally, increase the value of the break-voltage parameter.**

---

### Anti-stick

on / off

Factory setting: on

As the arc becomes shorter, the welding voltage may drop so far that the rod electrode will tend to stick. This may also cause the rod electrode to burn out.

Electrode burn-out is prevented by activating the anti-stick function. If the rod electrode begins to stick, the power source immediately switches the welding current off. After the rod electrode has been detached from the workpiece, the welding process can be continued without any problems.

---

# Ignition and mode settings

## Ignition parameters

### HF ignition

on / off / Touch HF / External  
Factory setting: on

on  
High frequency ignition is activated when welding is started

off  
No high-frequency ignition when welding is started.  
In this case, welding starts with touchdown ignition.

Touch HF  
The welding process is initiated by briefly touching the workpiece with the tungsten electrode. The high frequency ignition occurs after the set HF ignition delay time has elapsed.

External  
Start with external ignition aid, e.g. plasma welding

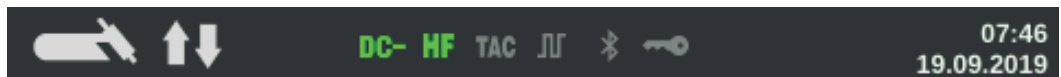

The HF ignition indicator in the status bar on the display lights up as long as HF ignition has been set to On.

### CAUTION!

#### **Risk of injury due to shock caused by electric shock**

Although Fronius devices comply with all relevant standards, high-frequency ignition can transmit a harmless but noticeable electric shock under certain circumstances.

- ▶ Use prescribed protective clothing, especially gloves!
- ▶ Only use suitable, completely intact and undamaged TIG hosepacks!
- ▶ Do not work in damp or wet environments!
- ▶ Take special care when working on scaffolding, work platforms, in forced positions (out-of-position welding), in tight, difficult to access or exposed areas!

### HF ignition delay time

Duration until the high frequency ignition takes place after touching the workpiece with the tungsten electrode.

0.1 - 5.0 s  
Factory setting: 1.0 s

### Reversed polarity ignition

(iWave AC/DC power sources only)

To optimise the ignition sequence in TIG DC welding, the polarity is reversed briefly when welding starts. Electrons emerge from the workpiece and strike the tungsten electrode. This results in rapid heating-up of the tungsten electrode - which in itself is an essential precondition for optimum ignition performance.

off / on  
Factory setting: off



**IMPORTANT!** Reversed polarity ignition is not recommended when welding light-gauge sheets.

---

---

## Arc monitoring

---

### Ignition timeout

Ignition timeout until safety cut-out after abortive ignition attempt.

0.1 - 9.9 s

Factory setting: 5 s

**IMPORTANT!** Ignition timeout is a safety function and cannot be deactivated. The description of the ignition timeout function can be found in the section "TIG welding".

---

### Arc-break time

Duration until safety cut-out after arc break

If, following an arc break, there is no current flow within the time specified here, the power source cuts out automatically.

To start the welding process again, press any key on the control panel or the torch trigger.

0.00 - 2.00 s

Factory setting: 0.20 s

---

### Arc break monitoring

Reaction if there is no current flow within the arc break time

ignore / Error

Factory setting: ignore

ignore

The interruption is ignored.

Error

An error message to be acknowledged is displayed on the power source.

---

---

## Operating mode defaults

---

### Torch trigger

Welding start using torch trigger

on / off

Factory setting: on

on

Welding is started via the torch trigger

off

Welding is started by touching the workpiece with the tungsten electrode; especially suitable for welding torches without a torch trigger, ignition sequence depending on ignition parameters

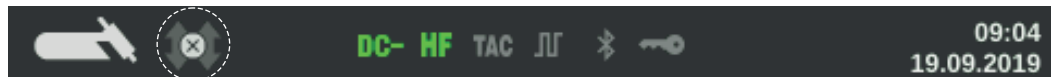

The display shows the symbol for the deactivated torch trigger in the status bar, the selection of the operating mode is deactivated.

---

### I2 via torch trigger

to activate / deactivate whether it is possible to switch over to the reduced current I<sub>2</sub> by means of the torch trigger

The setting of the I<sub>2</sub> via torch trigger parameter also influences variants 1 - 6 of the special 4-step mode (see from page 49).

on / off

Factory setting: off

---

### Reduced current button function

The setting of the Reduced current button function parameter also influences variants 1 - 6 of the special 4-step mode (see from page 49).

I<sub>1</sub> / I<sub>2</sub>

Factory setting: I<sub>2</sub>

---

### Arc break voltage

for setting a voltage value at which the welding process can be terminated by slightly raising the TIG welding torch.

The higher the break voltage, the higher the arc can be drawn.

The arc break voltage value is stored together for 2-step mode, 4-step mode and operation with a pedal remote control.

If the "Torch trigger" parameter is set to "off", the value is stored separately.

off / 6.0 - 90.0 V

Factory setting: off

---

### Comfort Stop sensitivity

The parameter is only available if the "Torch trigger" parameter is set to "off".

off / 0.1 - 10.0 V

Factory setting: off

At the end of the welding operation, the welding current is switched off automatically if the arc length increases by more than a defined amount. This prevents the arc from being unnecessarily lengthened when the TIG welding torch is lifted.

Sequence:

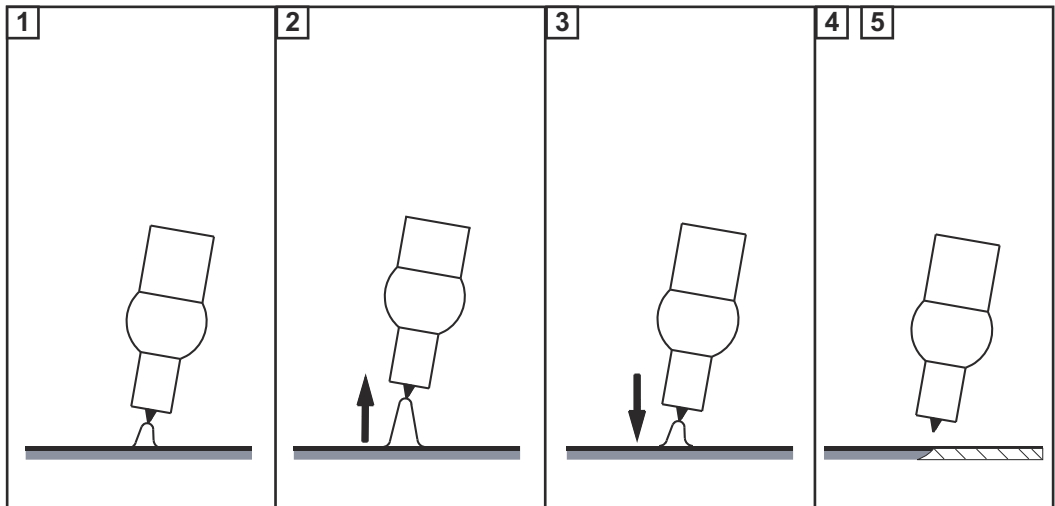

- 1 Welding
- 2 At the end of the welding action, briefly raise the welding torch  
The arc length is increased significantly.
- 3 Lower the welding torch
  - The arc length is reduced significantly
  - The Comfort Stop function has been activated
- 4 Keep the welding torch at the same height
  - The welding current is continuously decreased (DownSlope).
  - The arc goes out.

**IMPORTANT!** The DownSlope is pre-set and cannot be adjusted.

- 5 Raise the welding torch from the workpiece

# The gas menu

---

## Parameters in the Gas menu

---

### Gas pre-flow

Duration of gas pre-flow

0.0 - 9.9 s

Factory setting: 0.4 s

---

### Gas post-flow

Duration of gas post-flow

auto / 0 - 60 s

Factory setting: auto

auto

Depending on the electrode diameter and welding current, the power source calculates the optimum gas post-flow time and adjusts it automatically.

---

# The components menu

## Parameters in the Components menu

---

### Cooling unit operating mode

for controlling a cooling unit

eco / auto / on / off

Factory setting: auto

auto

When welding is started, the cooling unit starts to operate (fan and coolant pump are running).

After welding, the cooling unit continues to operate for 2 minutes. The cooling unit switches off after these 2 minutes.

on

Continuous operation

As soon as the power source is switched on, the cooling unit starts to operate (fan and coolant pump are running permanently)

off

No operation, even when welding is started

eco

The coolant pump starts when welding starts.

The fan starts working from a coolant return temperature of 40°C (104°F) (only in conjunction with the flow temperature sensor option).

When filling the torch hosepack, the coolant pump continues to run for 10 seconds once the flow rate is > 0.7 l/m.

Once welding stops, the cooling unit continues to run for at least another 15 seconds. As soon as the coolant return temperature is < 40 °C, the cooling unit cuts out.

The maximum post-run time is 2 minutes.

---

### Flow sensor filter time

(only if the flow temperature sensor option is present on the cooling unit)

to set the time from when the flow sensor responds until a warning message is output

5 - 25 s

Factory setting: 10 s

---

### Coolant flow warning level

(only if the flow temperature sensor option is present on the cooling unit)

If the parameter is activated, a warning is generated if the value entered is not reached.

off / 0.75 / 0.8 / 0.85 / 0.9 / 0.95

Factory setting: off

---

### Empty/fill torch hosepack

(only in conjunction with a MultiControl cooling unit CU 600t /MC or CU 600t MV/MC)

Function to drain and fill the torch hosepack, e.g. when changing the torch body.

A detailed description of the two functions follows.

---

## Emptying the torch hosepack

Prerequisites for emptying the torch hosepack:

- MultiControl cooling unit present
- Cooling unit operating mode = eco or auto
- Power source must not be in welding mode
- Torch hosepack must not be in the process of being filled via the "Fill torch hosepack" function
- Torch body must be fitted
- Torch hosepack must be connected up correctly

The torch hosepack can be emptied via the power source Setup menu or by entering a key combination on the TIG welding torch.

### Start via Setup menu

- 1 Access the Setup menu



- 2 Select the component settings



- 3 Select "Empty/fill torch hosepack":  
Turn and press adjusting dial
- 4 Ensure that the welding torch has been connected up correctly
- 5 Select "Start"

### Start via key combination on welding torch

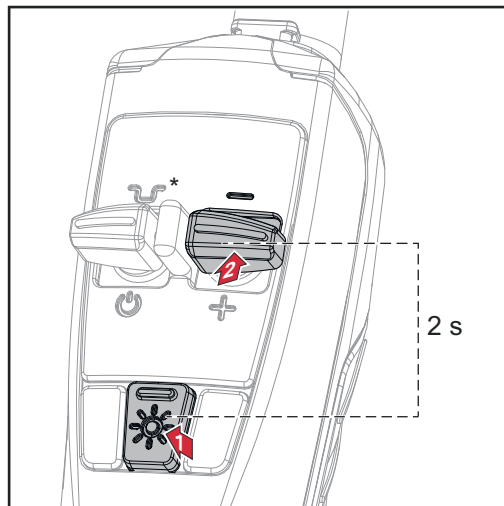

- 1 Press and hold the LED key
- 2 Press and hold the Down (-) key for 2 seconds

\* Press intermediate lowering key to interrupt the process

If the coolant temperature is too high, you will first need to wait for the coolant to cool down (cooling phase). During this cooling phase, the LED on the welding torch will flash roughly every 2 seconds.

The emptying process will start as soon as the coolant temperature is low enough. It takes roughly 30 seconds to empty the torch hosepack. During this time the LED on the welding torch will flash roughly every second.

When the emptying process has been completed successfully, a confirmation to this effect is displayed.

The torch body can now be changed.

Switch off the power source before changing the torch hosepack.

**IMPORTANT!** It is not possible to perform any welding operations with an empty torch hosepack!

## Filling the torch hosepack

Prerequisites for filling the torch hosepack:

- MultiControl cooling unit present
- Cooling unit operating mode = eco or auto
- Torch hosepack must not be in the process of being emptied via the "Empty torch hosepack" function
- Torch hosepack must be connected up correctly
- Torch body must be fitted

The torch hosepack can be filled via the power source Setup menu or by entering a key combination on the TIG welding torch.

### Start via Setup menu

- 1 Access the Setup menu



- 2 Select the component settings



- 3 Select "Empty/fill welding torch":  
Turn and press adjusting dial

A note will be displayed if the torch hosepack is empty.

- 4 Ensure that the welding torch is connected up correctly and the torch body is properly fitted
- 5 Press the Gas-test button



## Start via key combination on welding torch

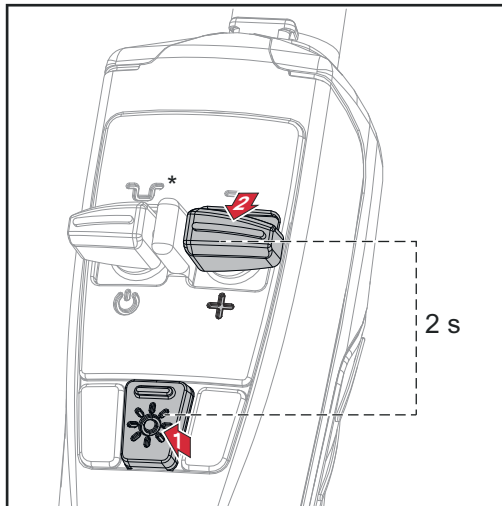

- 1 Press and hold the LED key
- 2 Press and hold the Up (+) key for 2 seconds

\* Press intermediate lowering key to interrupt the process

The filling process is started. It takes roughly 30 seconds to fill the torch hosepack. During this time the LED on the welding torch will flash roughly every second.

When the filling process has been completed successfully, a confirmation to this effect is displayed.

**IMPORTANT!** Before starting to weld again, check the operating mode of the cooling unit and, if necessary, apply the correct value for the task at hand.











# The documentation menu

## The documentation menu

### Displaying welds

- 1 Press the adjusting dial to display welds

The following data is also logged:

							
No.	ddmmyy	hhmmss	s	A	V	kJ	JOB No.
(1)	(2)	(3)	(4)	(5)	(6)	(7)	(8)

- (1) Welding operation number
- (2) Date (ddmmyy)
- (3) Time (hhmmss)
- (4) Welding duration in s
- (5) Welding current in A (average value)
- (6) Welding voltage in V (average value)
- (7) Arc energy in kJ
- (8) Job no.

Turn the adjusting dial to scroll through the list.

- 2 Select Close to exit the overview of the welds

### Displaying events

- 1 Press the adjusting dial to display the events

The logged events are displayed with the date and time.

- 2 Select Close to exit the overview of the events

### Displaying the logbook

- 1 Press the adjusting dial to display the logbook (welds and events)

The logged data is displayed in the same way as the welds.

- 2 Select Close to exit the logbook

### Basic settings / sampling rate

for setting the sampling rate

- 1 Press the adjusting dial

- 2 Turn the adjusting dial and change the sampling rate value:

off

Sampling rate is deactivated; only average values are stored.

0.1–100.0 s

Documentation is stored with the set sampling rate.

- 3 Press the adjusting dial to confirm the sampling rate

### **Limit monitoring**

for activating/deactivating limit monitoring

- 1** Press the adjusting dial
- 2** Turn the adjusting dial and change the value for limit monitoring:
  - off  
Limit monitoring is deactivated.
  - on  
Limit monitoring is activated according to the specifications.
- 3** Press the adjusting dial to accept the setting

# The Job menu

---

## Saving a job

When jobs are saved, the welding process and all the settings in the welding parameters and the respective Setup menus are saved.

When creating jobs you **MUST** therefore also take into account the welding parameters in the Setup menus.

Jobs can be saved in two ways:

- Save job via the Job menu
  - Save job using the adjusting dial
- 

## Saving a job via the Job menu

- 1 Set welding process, mode, welding parameters and setup parameters
- 2 Press the Menu key



- 3 Turn the adjusting dial and select the Job menu
- 4 Press the adjusting dial
- 5 Turn the adjusting dial and select "Save Job as ..."
- 6 Press the adjusting dial

An overview of the most important parameters is displayed.

- 7 Select "More" (turn adjusting dial and press)
- 8 Turn the adjusting dial:  
Overwrite existing job  
(after pressing the adjusting dial, a confirmation prompt asking whether you really want to overwrite the job is displayed)

or

Create new job

Press the adjusting dial; the first available job number is displayed.

- 9 Select Job number (turn adjusting dial and press)
- 10 Select "More" (turn adjusting dial and press)

The keyboard is displayed.

- 11 Turn and press the adjusting dial to enter a name for the job
- 12 Select "More" (turn adjusting dial and press)

A message confirming that the job has been saved is displayed.

- 13 Select "Finish" (turn adjusting dial and press)
- 

## Saving a job using the adjusting dial

- 1 Set welding process, mode, welding parameters and setup parameters
- 2 Press the adjusting dial for more than 3 seconds

An overview of the most important parameters is displayed.

- 3 Select "More" (turn adjusting dial and press)
- 4 Turn the adjusting dial:  
Overwrite existing job  
(after pressing the adjusting dial, a confirmation prompt asking whether you really want to overwrite the job is displayed)

or

Create new job

Press the adjusting dial; the first available job number is displayed.

- 5 Select Job number (turn adjusting dial and press)
- 6 Select "More" (turn adjusting dial and press)

The keyboard is displayed.

- 7 Turn and press the adjusting dial to enter a name for the job
- 8 Select "More" (turn adjusting dial and press)

A message confirming that the job has been saved is displayed.

- 9 Select "Finish" (turn adjusting dial and press)

---

## Loading a job

The Load job function can be used to load the data for a saved job or an EasyJob into the welding parameters.  
The relevant data from the job can be changed, saved as a new job or EasyJob, or used to start welding.

- 1 Press the Menu key



- 2 Turn the adjusting dial and select the Job menu
- 3 Press the adjusting dial
- 4 Turn the adjusting dial and select "Load Job ..."
- 5 Press the adjusting dial

The job list is displayed.

- 6 Select the job that you want to load (turn adjusting dial and press)

A message advising that the job is about to be loaded is displayed.

- 7 Select "Yes" (turn adjusting dial and press)

The job is loaded into the welding parameters.

## Deleting a job

- 1 Press the Menu key



- 2 Turn the adjusting dial and select the Job menu
- 3 Press the adjusting dial
- 4 Turn the adjusting dial and select "Delete Job ..."
- 5 Press the adjusting dial

The job list is displayed.

- 6 Select the job that you want to delete (turn adjusting dial and press)

A warning that the job is about to be deleted is displayed.

- 7 Select "Yes" (turn adjusting dial and press)

The job is deleted.

## Optimising job process parameters

The following process parameters can be set for job optimisation:

### Job parameters

Starting current [% of main current]	DownSlope [s]
UpSlope [s]	Final current [% of main current]
Main current [A]	AC balance on iWave AC/DC power sources only [%]
Reduced current for 4-step mode [% of main current]	Electrode diameter [mm]

### Welding process settings

Polarity [DC- / AC]	TIG welding torch mode [2-step / 4-step / Spot welding]
------------------------	--

### TIG pulse settings

Tacking [s]	Duty cycle [%]
Pulse frequency [Hz]	Pulse waveform [Rectangle / Triangle / Sine]
Base current [% of main current]	Base current waveform [Rectangle / Triangle / Sine]

### TIG AC settings

(on iWave AC/DC power sources only)

AC frequency [Hz]	Positive half-wave waveform [Rectangle / Triangle / Sine]
AC current offset [%]	Negative half-wave waveform [Rectangle / Triangle / Sine]

### Ignition parameters

HF ignition [on / off / Touch HF / External]	Reversed polarity ignition [off / on]
HF ignition delay [s]	

### Arc monitoring

Ignition timeout [s]	Arc break watchdog [ignore / Error]
Arc break filter time [s]	

### Mode settings

Arc break voltage [V]	Comfort Stop Sensitivity [V]
--------------------------	---------------------------------

### General settings

Starting current time [s]	Reduced current slope 2 [s]
Final current time [s]	Spot welding time [s]
Reduced current slope 1 [s]	

### TIG gas settings

Gas pre-flow [s]	Gas post-flow [s]
---------------------	----------------------

### Job correction limits

Upper main current limit 0 - 50% Factory setting: 0%	Job slope defines the time between the job that is currently selected and the next job 0.0 - 10.0 s Factory setting: 0 s
Lower main current limit -50 - 0% Factory setting: 0%	

## CycleTIG settings

CycleTIG activated	Interval cycles
Interval time [s]	Base current [A]
Interval break time [s]	

## Documentation

Sampling rate
---------------

## Limit monitoring

Voltage command value  0.0 - 100.0 V Factory setting: 100.0 V	Lower welding duration limit  -50.0 - 0.0 s Factory setting: -1.0 s
Lower voltage limit  -10.0 - 0.0 V Factory setting: -1.0 V	Upper welding duration limit  0.0 - 50.0 s Factory setting: 1.0 s
Upper voltage limit  0.0 - 10.0 V Factory setting: 1.0 V	Welding time monitoring  off / on Factory setting: off
Max. time of voltage deviation  off / 0.1 - 10.0 s Factory setting: off	Energy command value  0.0 - max. kJ Factory setting: 1.0 kJ
Current command value  0.0 - 1000.0 A Factory setting: -	Lower energy limit  -100.0 - 0.0 kJ Factory setting: 0.0 kJ
Lower current limit  -100 - 0 A Factory setting: - 10 A	Upper energy limit  0.0 - 100.0 kJ Factory setting: 1.0 kJ
Upper current limit  0 - 100 A Factory setting: 10 A	Energy monitoring  off / on Factory setting: off
Max. time of current deviation  off / 0.1 - 10.0 s Factory setting: off	Limit reaction  ignore / Warning / Error Factory setting: ignore
Welding duration command value  0.0 - 999.9 s Factory setting: 5.0 s	

## Job number online

to activate / deactivate whether the active job in Job Mode is changed over and processed at the same time

---

**Defaults for  
"Save job"**

After confirming the displayed information, the following process parameters can be set for the "Save as Job" pre-settings:

**Job slope**

---

**Job slope**

defines the time between the job that is currently selected and the next job

0.0 - 10.0 s

Factory setting: 0 s

---

**Job correction limits**

---

**Upper main current limit**

for setting the upper main current limit for a job

0.0 - 20.0%

Factory setting: 0

---

**Lower main current limit**

for setting the lower main current limit for a job

-20.0 - 0.0%

Factory setting: 0

---

**Limit monitoring**

---

**Voltage command value**

0.0 - 100.0 V

Factory setting: 100.0 V

---

**Lower voltage limit**

-10.0 - 0.0 V

Factory setting: -1.0 V

---

**Upper voltage limit**

0.0 - 10.0 V

Factory setting: 1.0 V

---

**Max. time of voltage deviation**

off / 0.1 - 10.0 s

Factory setting: off

---

**Current command value**

0.0 - 1000.0 A

Factory setting: -

---

**Lower current limit**

-100 - 0 A

Factory setting: - 10 A

---

**Upper current limit**



0 - 100 A  
Factory setting: 10 A

---

#### **Max. time of current deviation**

off / 0.1 - 10.0 s  
Factory setting: off

---

#### **Welding duration command value**

0.0 - 999.9 s  
Factory setting: 5.0 s

---

#### **Lower welding duration limit**

-50.0 - 0.0 s  
Factory setting: -1.0 s

---

#### **Upper welding duration limit**

0.0 - 50.0 s  
Factory setting: 1.0 s

---

#### **Welding time monitoring**

off / on  
Factory setting: off

---

#### **Energy command value**

0.0 - max. kJ  
Factory setting: 1.0 kJ

---

#### **Lower energy limit**

-100.0 - 0.0 kJ  
Factory setting: 0.0 kJ

---

#### **Upper energy limit**

0.0 - 100.0 kJ  
Factory setting: 1.0 kJ

---

#### **Energy monitoring**

off / on  
Factory setting: off

---

#### **Limit reaction**

ignore / Warning / Error  
Factory setting: ignore

---

---

#### **EasyJobs on Favourites button**

The procedure for saving EasyJobs on the Favourites button is described starting from page [30](#).

# Defaults

---

## Overview

Defaults contains the following sections:

### Display

- Backlighting
- Languages
- Date & time
- Show system data
- Display additional parameters
- iJob parameter display

### System

- Power source configuration
- Reset to factory settings
- Reset website password
- Torch trigger I2 - cap mode
- Perform R/L alignment

### Network settings

- Bluetooth on
- Configure Bluetooth devices
- Network settings
- Activate WLAN
- WLAN settings

### User management

- Create user / overview
- Create role / overview
- CENTRUM server

### Management

- Trial Lizenz

## Backlighting

### Backlighting

to set the brightness of the display

Unit -

Setting range 0 - 10

Factory setting 10

Adjust backlighting:

- 1 Defaults / Display / Backlighting
- 2 Press the adjusting dial
- 3 Select backlighting brightness (turn adjusting dial and press)

---

## Languages

### Language

Setting range: dependent on the software version

Factory setting: English

Setting the language:

- 1 Defaults / Display / Language
- 2 Select the desired language (turn adjusting dial and press)

The Globe symbol appears briefly and the language changes.

---

## Time & Date

### Time & Date

to set the time and date

Setting range: Year / Month / Day / Hour / Minute / Time zone

Factory setting: -

Setting the date & time:

- 1 Defaults / Display / Time & Date
- 2 Select the desired parameter (turn adjusting dial and press)
- 3 Modify parameter by turning the adjusting dial
- 4 Confirm the modified parameter by pressing the adjusting dial
- 5 Press the menu key to exit the date and time settings

**Show system data**

After selecting "Show system data", the current system data of the welding system is displayed:

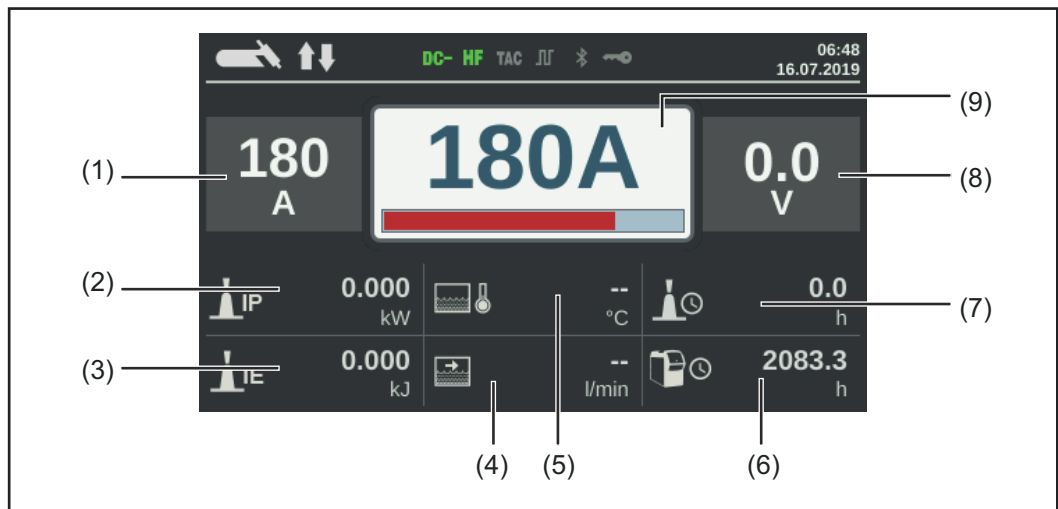

- (1) Welding current actual/hold value
- (2) Current arc power
- (3) Current arc energy
- (4) Coolant circulation
- (5) Coolant temperature
- (6) Total operating hours
- (7) Current flow time
- (8) Welding voltage
- (9) Welding current command value

Press the adjusting dial to hide the system data and return to the welding parameters screen.

## Display additional parameters

In the case of welding parameters 1 - 3, this function enables additional parameters or settings to be displayed.

- Not assigned
- Process
- TIG welding torch mode
- TIG settings:  
Tacking, pulse frequency, base current, duty cycle, pulse waveform, base current waveform, starting current time, final current time, spot welding time, reduced current slope 1, reduced current slope 2, AC frequency, AC current offset, positive half-wave waveform, negative half-wave waveform
- Electrode settings:  
Starting current time, characteristic, break voltage, anti-stick, AC frequency
- CEL settings:  
Starting current time, break voltage, anti-stick
- Ignition settings:  
HF ignition, HF ignition delay time, ignition timeout, arc break filter time, arc break monitoring, torch trigger, arc-break voltage, comfort stop sensitivity, reversed polarity ignition
- Gas settings:  
Gas pre-flow, gas post-flow
- Components settings:  
Cooling unit operating mode, filter time flow sensor, cooler flow warning limit

Display additional parameters:

- 1** Default / Display / Display additional parameters
- 2** Press the adjusting dial
- 3** Select parameter location P1 - P3 (turn and press adjusting dial)
- 4** Choose which parameter to display in the selected parameter location (turn adjusting dial and press)
- 5** Select Save (turn adjusting dial and press)

The parameter is displayed in the selected parameter location, where it can now also be modified.

---

## **iJob parameter display**

In the case of jobs, this function enables additional parameters or settings to be stored.

- Job parameters:  
Starting current, UpSlope, reduced current, DownSlope, final current, AC balance, electrode diameter
- Welding process settings:  
Cap mode, polarity
- TIG pulse settings:  
Tacking, pulse frequency, base current, duty cycle, waveform pulse, waveform base current
- AC settings:  
AC frequency, positive half-wave waveform, negative half-wave waveform
- Ignition & mode settings:  
reversed polarity ignition
- General settings:  
2-step setup (starting current time, final current time)  
  
4-step settings (reduced current slope 1, reduced current slope 2)  
  
Spot welding settings (spot welding time)
- CycleTIG:  
CycleTIG activated, interval time, interval break time, interval cycles, base current

### **To display the iJob parameter display:**

- 1** Defaults / Display / Select iJob parameter display
- 2** Turn the adjusting dial and select the desired group
- 3** Press the adjusting dial
- 4** Turn the adjusting dial and select the desired parameter
- 5** Press the adjusting dial
- 6** Select Save to exit the iJob parameter display

The parameter is displayed in the jobs, where it can now also be modified.

---

## Power source configurations

- 1 Defaults / System / Power source configuration
- 2 Press the adjusting dial
- 3 Select name, plant, hall, cell, additional info by turning the adjusting dial
- 4 Press the dial to edit the selection

The keyboard is displayed.

- 5 Enter the configuration data by turning and pressing the adjusting dial
- 6 Select "OK" (turn adjusting dial and press)
- 7 After entering all configuration data, select "Save" (adjusting dial wheel and press)

---

## Reset to factory settings

- 1 Defaults / System / Reset to factory settings
- 2 Press the adjusting dial

A confirmation prompt asking whether you really want to restore the factory settings is displayed.

- 3 Select yes by turning the adjusting dial
- 4 Press the adjusting dial to reset to factory settings

The power source is reset to the factory settings.

---

## Reset website password

- 1 Defaults / System / Reset website password
- 2 Press the adjusting dial

A confirmation prompt asking whether you really want to reset the website password is displayed.

- 3 Select yes by turning the adjusting dial
- 4 Press the adjusting dial to reset the website password

The website password is reset to the factory setting:  
User name = admin  
Password = admin

---

## Torch trigger I2 - cap mode

- 1 Defaults / System / Torch trigger I2 - cap mode
- 2 Press the adjusting dial
- 3 Select off or on by turning the adjusting dial

off

It is not possible to activate cap mode by actuating the torch trigger for a long time.

on

Cap mode is activated by actuating the torch trigger for a long time.

- 4 Press the adjusting dial

## Performing R/L alignment

### NOTE!

R/L alignment must be carried out separately for each welding process.

### Welding circuit resistance R [mOhm]

Measuring the welding circuit resistance "r" provides information on the overall resistance of the torch hosepack, welding torch, workpiece and grounding cable.

If an increased welding circuit resistance is detected, e.g. after changing the welding torch, this may mean that the following components are faulty:

- Torch hosepack
- Welding torch
- Grounding (earthing) connection to the workpiece
- Grounding cable

### Welding circuit inductivity L [ $\mu$ H]

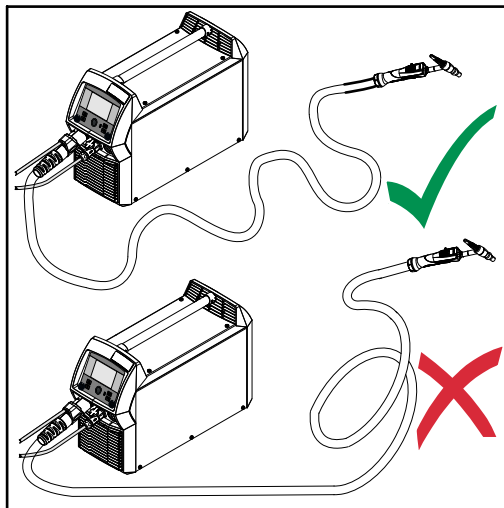

The way that the hosepack is arranged has a very significant effect on the weld properties. Particularly with pulsed-arc welding and AC welding, a high welding circuit inductivity may occur, depending on the length of the hosepack and on the way that it is arranged. The result is that the current rise is restricted.

The weld results can be optimised by changing the arrangement of the torch hosepack. The hosepack must be laid out as shown in the illustration.

### Performing R/L alignment

- 1 Defaults / System / Perform R/L alignment
- 2 Press the adjusting dial  
The current values are displayed
- 3 Select More (turn adjusting dial and press)  
The second R/L alignment screen is displayed.
- 4 Follow the instructions displayed on the screen
- 5 Select More (turn adjusting dial and press)  
The third R/L alignment screen is displayed.
- 6 Follow the instructions displayed on the screen



**7** Select More (turn and press adjusting dial)

The current values are calculated.

After R/L alignment has been completed, a confirmation and the current values are displayed.

# Network settings

---

## General

Each Bluetooth user has its own MAC address. This MAC address can be used to assign the devices to specific power sources, preventing mix-ups.

The power source is able to communicate with the following devices:

- Remote control RC Panel Basic /BT
- Pedal remote control RC Pedal TIG /BT
- Welding helmet Vizor Connect /BT

An active Bluetooth connection is indicated in the status bar on the display by an illuminated Bluetooth symbol.

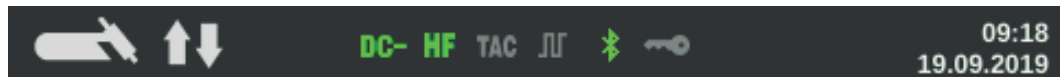

For safety reasons, when using Bluetooth devices of the same type, only one device can be actively connected to the power source.

It is possible to establish multiple active Bluetooth connections when using Bluetooth devices of different types.

New Bluetooth devices must always be configured in the Setup menu.

An existing, active Bluetooth connection cannot be interrupted or influenced by another Bluetooth user.

Bluetooth remote controls have priority over wired remote controls or welding torches with control functions.

If the connection between a wired or Bluetooth remote control and the power source is interrupted during the welding process, the welding process is ended.

---

## Bluetooth on

### Bluetooth on

to activate/deactivate the Bluetooth function

Setting range: on / off (check box)

Factory setting: off

Activating/deactivating the Bluetooth function:

**1** Defaults / Network settings / Bluetooth on

**2** To activate/deactivate the Bluetooth function, press the adjusting dial



Bluetooth function deactivated



Bluetooth function activated

Bluetooth devices can be configured when the Bluetooth function is active.

## Configuring Bluetooth devices

- 1 Switch on the Bluetooth device
- 2 Defaults / Network settings / Configure Bluetooth devices
- 3 Press the adjusting dial

All Bluetooth devices detected are displayed in a list along with their names, MAC addresses and additional information.

- 4 Turn the adjusting dial and select the desired Bluetooth device
- 5 Compare the MAC address displayed with the MAC address on the device

Press the adjusting dial to create an active connection with the selected device

A prompt to connect to the Bluetooth device is displayed.

- 6 Select Yes

An active connection to the selected Bluetooth device is established. The active connection is displayed under Info.

Symbols displayed under Info:



### Active Bluetooth connection

An active change can be made to the power source via the Bluetooth device. Depending on the availability of the data, additional data such as the battery status, signal strength, etc. of the Bluetooth device is also displayed.



### Paired

The Bluetooth device has already been actively connected to a power source at least once and appears in the list of the Bluetooth devices.



### Inactive

A new Bluetooth device has been detected or the Bluetooth device was removed by the user.

## Network setup

- 1 Defaults / Network settings / Select network settings
- 2 Press the adjusting dial

The network setup overview is displayed.

If DHCP is enabled, the IP address, Network mask, Standard gateway, DNS Server 1 and DNS Server 2 parameters are greyed out and cannot be adjusted.

- 3 Turn the adjusting dial and select "DHCP"

DHCP is disabled, the network parameters can now be set.

- 4 Turn the adjusting dial and select the desired network parameter
- 5 Press the adjusting dial

The numerical pad for the selected parameter is displayed.

- 6 Enter a value for the network parameter
- 7 Select "Save" and confirm the value for the network parameter / press the adjusting dial

The value for the network parameter is applied, the network setup overview is displayed.

- 8 Select "Store" to apply changes to the network setup

---

## Activating WLAN

### Activate WLAN

to activate/deactivate the WLAN function

Setting range: on / off (check box)

Factory setting: off

To activate/deactivate the WLAN function:

- 1 Defaults / Network settings / Enable WLAN
- 2 To activate/deactivate the WLAN function, press the adjusting dial



WLAN function deactivated



WLAN function activated

When the WLAN function is activated, the WLAN settings can be executed.

---

## WLAN settings

- 1 Preferences / Network settings / Select WLAN settings
- 2 Press the adjusting dial

The available WLAN networks are displayed.

- 1 Select "Country" and press the adjusting dial
- 2 Select "Country" and press the adjusting dial
- 3 Turn the adjusting dial and select the corresponding country
- 4 Press the adjusting dial
- 5 Select "Save" and press the adjusting dial
- 6 Select "OK" and press the adjusting dial

# User management

---

## Overview

User management consists of the following sections:

- General
- Create users and roles
- Edit user / roles, deactivate user administration
- CENTRUM server

# General

---

**General remarks** User management is advisable if several users work with the same power source. User management works with different roles and the help of NFC keys.

Users are assigned different roles depending on their level of training or qualifications.

---

## Explanation of terms

### **Administrator**

An administrator has unlimited access rights to all functions on the power source. The administrator's duties include:

- creating roles,
- editing and managing user data,
- assigning access rights,
- updating the firmware,
- backing up data, etc.

### **User management**

User management encompasses all users registered on the power source. Users are assigned different roles depending on their level of training or qualifications.

### **NFC card**

An NFC card or an NFC key ring is assigned to a certain user who is registered on the power source.

NFC cards and NFC key rings will both be referred to under the general term NFC key for the purpose of these Operating Instructions.

**IMPORTANT!** Each user should be assigned their own NFC key.

### **Roles**

Roles are used for managing registered users (= user management). Users' access rights and permitted activities are defined by their roles.

---

## Pre-defined roles and users

Two roles are predefined in the factory under Defaults / User management:

### **administrator**

with full rights and options

The "administrator" role cannot be deleted, renamed or edited.

The "administrator" role is assigned the pre-defined "admin" user, which cannot be deleted. The "admin" user can assign names, languages, units, web passwords and NFC keys.

As soon as "admin" assigns an NFC key, user management is activated.

### **locked**

Factory-set with access to welding processes, but not to process parameters and defaults

The "locked" role

- cannot be deleted or renamed
- cannot be edited to approve different functions according to demand

The "locked" role cannot have any NFC keys assigned to it.

If no NFC key is assigned to the pre-defined "admin" user, every NFC key will work to lock and unlock the power source (no user management, see "Locking and unlocking the power source using the NFC key", page 44).

---

**Recommendation  
for creating roles  
and users**

Please proceed systematically when creating roles and NFC keys.

Fronius recommends creating one or two administrator keys. Without administrator rights, it may in the worst-case scenario no longer be possible to operate a power source.

**NOTE!**

**Losing an NFC administrator key can lead to the power source becoming unusable, depending on the settings. Keep one of the two NFC administrator keys in a safe place.**

---

**Procedure**

- 1 Create two equivalent users with the "administrator" role

This means that access to the administrator function is retained even if an administrator NFC key is lost.

- 2 Consider further roles:
  - How many roles are needed?
  - Which rights will be assigned to each role?
  - How many users are there?
- 3 Create roles
- 4 Assign users to roles
- 5 Check that the created users have access to their respective roles with their NFC keys.

# Create users and roles

---

## Creating a user

### NOTE!

If an NFC key is assigned to the predefined user "admin" under Defaults / User management / Create user - overview, the user administration is activated.

---

1 Defaults / User management / Create user - overview

2 Press the adjusting dial

The list of existing users is displayed.

3 Turn the dial and select "Create new user"

4 Press the adjusting dial

The keyboard is displayed.

### NOTE!

For privacy reasons, only person identity numbers and not full names should be entered when creating users.

---

5 Enter the user name by turning and pressing the adjusting dial

6 Select "OK"

"Edit user" is displayed.

7 By turning the dial, select the desired entry, press the dial to edit the entry:

- Username \*
- Role \*\*
- First name \*
- Last name \*
- Language \*\*
- Unit \*\*
- Standard \*\*
- NFC card:  
Follow the instructions shown  
(hold the new NFC key on the NFC key read zone and wait for the recognition confirmation)
- Web password \*
- Mobile device:  
Follow instructions on the WeldConnect app

\* Input via keyboard

\*\* Select from list

8 Select "Save" and press the adjusting dial

---

## Creating roles

1 Defaults / User management / Create role - overview

2 Press the adjusting dial

The list of existing roles is displayed.



**3** Turn the dial and select "Create new role"

**4** Press the adjusting dial

The keyboard is displayed.

**5** Enter the role name by turning and pressing the adjusting dial

**6** Select "OK"

"Edit role" is displayed.

**7** Select the functions that can be carried out by this role by turning the adjusting dial, press the adjusting dial to enable the function.

Symbols:



... hidden



... read only



... read and write

**8** Select "Save" and press the adjusting dial

# Edit user / roles, deactivate user administration

---

## Editing users

- 1 Defaults / User management / Create user - overview
- 2 Press the adjusting dial

The list of existing users is displayed.

- 3 Turn the adjusting dial and select the user to be edited
- 4 Press the adjusting dial

"Edit user" is displayed.

- 5 By turning the dial, select the desired entry, press the dial to edit the entry:  
Input via keyboard or selection from list
- 6 Press the adjusting dial
- 7 Select "Save" and press the adjusting dial

---

## Editing roles

- 1 Defaults / User management / Create role - overview
- 2 Press the adjusting dial

The list of existing roles is displayed.

- 3 Turn the adjusting dial and select the role to be changed
- 4 Press the adjusting dial

"Edit role" is displayed.

- 5 Select the desired function by turning the adjusting dial, press the adjusting dial to edit the function
- 6 Press the adjusting dial
- 7 Select "Save" and press the adjusting dial

---

## Deactivating user management

- 1 Defaults / User management / Create user - overview
- 2 Press the adjusting dial
- 3 Select the predefined user "admin"
- 4 Turn the adjusting dial and select "NFC card"
- 5 Press the adjusting dial

The NFC card replacement or deletion prompt appears.

### **NOTE!**

**If the NFC card is deleted by the predefined "admin" user, user management is deactivated.**

---

- 6 Select "delete"

User management is deactivated, the power source is locked.

The power source can be locked and unlocked again with any NFC key (see page [44](#)).

# CENTRUM - Central User Management

---

## Activating the CENTRUM server

CENTRUM is a piece of software for the central management of users. Detailed information is available in the CENTRUM Operating Instructions (42,0426,0338,xx).

The CENTRUM server can also be activated using the power source, as follows:

- 1 Defaults / User management / CENTER server
- 2 Press the adjusting dial

"CENTRUM server settings" is displayed.

- 4 Select "CENTRUM server activated" and press the adjusting dial
- 5 Select "CENTRUM server", press the adjusting dial and enter the address of the CENTRUM server using the keyboard
- 6 Select OK
- 7 Select the "Verify" button
- 8 Save

# Management

---

## **Trial license**

The trial license allows you to use and test all currently available functional packages free of charge on the power source.

Once the trial license is activated, all functional packages and extensions are available for a period of 10 hours of arc time. A warning message appears 2 hours before the trial license expires.

An activated trial license cannot be interrupted, an expired trial license cannot be reactivated.

The trial license is supplied as standard with the power source.

---

## **Activating the trial license**

**1** Defaults / Management / Trial License

**2** Press the adjusting dial

The information for activating the trial license is displayed.

**3** Select "Next"

**4** Register via WeldConnect

**5** Select "Next"

**6** Start trial license by selecting "Next"

**7** Confirm prompt

The confirmation that the trial license has been started is displayed.

**8** Select "Exit"

Under Management, the remaining time until the trial license expires is displayed.

# System informations

---

## Device information

The following data is displayed in device information:

**Serial number**

**Image version**

**Software ver.**

**IP addr.(es)**

### **Show open source licences...**

- Turn the adjusting dial to select "Show open source licences..."
- Press the adjusting dial

The open source licences used are displayed.

- Select close by turning the adjusting dial
- Press the adjusting dial



# **SmartManager - The power source website**





# SmartManager - The power source website

---

## General

The power source has its own website: SmartManager.

As soon as the power source is connected to a computer using a network cable, or is on a network, the power source's SmartManager can be retrieved using the power source's IP address.

At least IE 10 or a similar modern browser is required to access SmartManager.

The entries displayed on SmartManager may vary depending on system configuration, software upgrades and available options.

Examples of entries displayed:

- Current system data
  - Documentation, logbook
  - Job data (only if the OPT/i Jobs function package is present)
  - Power source settings
  - Backup & restore
  - User management
  - Overview
  - Update
  - Function packages
  - Screenshot
- 

## Calling up the power source SmartManager

**1** Note down the IP address for the power source in system information

**2** Enter the IP address in the browser search field

**3** Enter user name and password

Factory setting:

User name = admin

Password = admin

The power source SmartManager is displayed.

---

## Fronius



A click on the Fronius logo opens the homepage of Fronius: [www.fronius.com](http://www.fronius.com).

---

## Changing password / logging off

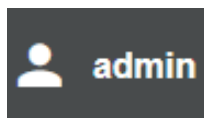

By clicking this symbol

- the user password can be changed
- you can log out of SmartManager

Changing the password for the SmartManager:

**1** Enter the old password

- 2 Enter the new password
  - 3 Repeat the new password
  - 4 Click on "Save"
- 

## Language



The languages available for SmartManager can be displayed by clicking on this symbol.

The current language selection is displayed next to the symbol.

To change the language, click on the one you would like.

# Current system data

## Current system data

Depending on the welding process, the current data on the welding system is displayed, e.g.:

### TIG

- Process
- ACTUAL or HOLD
- Welding current
- Welding voltage
- Current arc power
- Current arc energy
- Coolant flow \*
- Coolant temperature \*
- Shielding gas flow rate
- Arc time
- Total operating hours
- Operating mode

### Rod electrode / CEL

- Process
- ACTUAL or HOLD
- Welding current
- Welding voltage
- Starting current
- Arc-force dynamic
- Current arc power
- Current arc energy
- Arc time
- Total operating hours

### Job

- Process / Job name / Job no.
- Additional data as per the welding process saved under the job

\* Only if cooling unit with OPT/i CU flow temperature sensor option fitted is being used

# Documentation, logbook

---

## Logbook

The last 100 logbook entries are shown in the Logbook entry. These logbook entries can be welding operations, errors, warnings, notifications and events.

Press the "Time filter" button to restrict the data to a specific period of time. To do so, the date (yyyy mm dd) and time (hh mm) are entered in the format from – to in each case.

A blank filter loads the latest welding operations again.

The option to show welding operations and events can be disabled.

### The following data is displayed:



- (1) Welding operation number
- (2) Start time (date and time)
- (3) Welding duration in s
- (4) Welding current in A (average value)
- (5) Welding voltage in V (average value)
- (6) IP - arc power in W (from real-time values in accordance with ISO/TR 18491)
- (7) IE - arc energy in kJ (in total across the entire weld in accordance with ISO/TR 18491)

Jobs are also displayed if present in the system.

Clicking on a logbook entry will display details.

### Details for welds:

- Section no.
- Duration of the welding section in s
- Welding current in A (average value)
- Welding voltage in V (average value)
- Welding speed (cm/min)
- Arc power from real-time values in W
- Arc energy in kJ
- Job no.
- Process



Further values can be displayed by clicking on the "Insert column" button, such as the start time (power source time).

If the OPT/i documentation option is available on the power source, individual welding sections can also be displayed.



This documentation can be exported in the desired format using the "PDF" and "CSV" buttons.

In order to create CSV exports, the OPT/i documentation option must be available on the power source.

---

**Basic settings**

The sampling rate for the documentation can be set in the basic settings entry.

# Job-Data

---

## Job data

The Job data entry is only displayed if the FP Job function package is present in the power source.

In the "Job data" entry,

- existing welding system jobs can be viewed
  - existing welding system jobs can be optimised
  - jobs stored externally can be transferred to the welding system
  - existing jobs in the welding system can be exported as a PDF \* or CSV file
- 

## Job overview

The job overview lists all jobs stored in the welding system. Clicking on a job displays the data and parameters stored for this job. Job data and parameters can only be viewed in the job overview. The column width for parameters and values can be easily dragged and adjusted with the mouse pointer. Other jobs can easily be added to the list with the data listed by clicking on the "Add column" button.



This offers a simple way of comparing the values from various jobs.

---

## Editing a job

Existing welding system jobs can be edited.

- 1 Click on "Edit job"
- 2 Click on the job to be amended in the list of available jobs

The selected job is opened and the following job data is shown:

- **Parameter**  
The parameter currently stored in the job
- **Value**  
The values of the parameter currently stored in the job
- **Change value to**  
To enter the new parameter value
- **Setting range**  
Possible setting range for the new parameter values

- 3 Amend the values accordingly
- 4 Save / Delete adjustments, Save as / Delete job



As an aid when editing a job, other jobs can be easily added to the list with the data displayed by clicking on "Add column".



## Creating a new job

- 1 Click on "Create new job"



- 2 Enter job data
- 3 Click on "OK" to apply the new job

## Importing a job

This function enables previously exported jobs to be transferred into the welding system.

- 1 Click on "Search Job-file"
- 2 Select desired job file

Individual jobs can be selected and new job numbers assigned in the preview of the job import list.

- 3 Click on "Import Job"

If the import is successful, a corresponding confirmation is displayed and the imported jobs appear in the list.

## Exporting a job

This function enabled jobs to be exported from the power source and saved externally.

- 1 Select jobs to be exported:
  - Click on the job and the arrow
  - or
  - Double-click on the job
  - or
  - Drag & drop

- 2 Click on "Export Job"

The jobs are exported as an XML file into the computer's Download folder.

## Exporting job(s) as...

Existing jobs in the welding system can be exported as a PDF or CSV file under Job overview and Edit job.

- 1 Click on "Export job(s) as..."



The PDF or CSV settings are displayed.

- 2 Select the job(s) to be exported:  
current job / all jobs / job numbers
- 3 Click on "Save PDF" or "Save CSV"

A PDF or CSV file containing the selected jobs is created and saved according to the settings of the browser in question.

# Backup & Restore

---

## General

In the backup & restore entry

- all welding system data can be saved as a backup (e.g. current parameter settings, jobs, defaults, etc.),
  - any existing backups can be restored to the welding system
- 

## Backup & Restore

### Starting backup

- 1 Click on "Start backup" to create a backup of the welding system data

The data is saved in the selected location in the default format  
Backup\_SNxxxxxxxx\_JJJJ\_MM\_TT\_HHmmSS.fbc

SNxxxxxxxx = Serial number (8 digits)  
YYYY = Year  
MM = Month  
DD = Day  
HH = Hour  
mm = Minute  
SS = Second

The date and time correspond to the power source settings.

### Searching for a restore file

- 1 Click on "Search restore file" to transfer an existing backup to the power source
- 2 Select the file and click on "Open"

The selected backup file is displayed on the power source SmartManager under "Restore".

- 3 Click on "Start recovery"

Once the data has been successfully restored, a confirmation to this effect is displayed.



# User management

---

## General

In the user management entry

- users can be created, viewed and changed.
- user roles can be created, viewed and changed.
- users and user roles can be exported or imported on the power source.  
User management data present on the power source is overwritten by importing.
- a CENTRUM server can be activated.

User management is created on a power source and can then be saved with the export/import function and transferred to another power source.

---

## Users

Existing users can be viewed, changed and deleted; new users can be created.

### Viewing/changing a user:

- 1 Select user
- 2 Alter the user data directly in the display field
- 3 Save changes

### Deleting a user:

- 1 Select user
- 2 Click the "Delete user" button
- 3 When prompted, confirm with OK

### Creating a user:

- 1 Click the "Create new user" button
  - 2 Enter user data
  - 3 Confirm with OK
- 

## User roles

Existing user roles can be viewed, changed and deleted, new user roles can be created

### Viewing/changing a user role:

- 1 Select user role
- 2 Alter the user role directly in the display field
- 3 Save changes

The "Administrator" role cannot be changed.

### Deleting a user role:

- 1 Select user role
- 2 Click the "Delete user role" button
- 3 When prompted, confirm with OK

The "Administrator" and "Locked" roles cannot be deleted.

### Creating a user role:

- 1 Click the "Create new user role" button
  - 2 Enter a role name, apply values
  - 3 Confirm with OK
- 

## **Export & import      Exporting users and user roles from a power source**

- 1 Click on "Export"

The user management data from the power source will be saved to the "Downloads" folder on the computer.

File format: userbackup\_SNxxxxxxx\_YYYY\_MM\_DD\_hhmmss.user

SN = Serial number, YYYY = Year, MM = Month, DD = Day  
hh = hour, mm = minute, ss = second

### **Importing users and user roles to a power source**

- 1 Click on "Search user data file"
- 2 Select the file and click "Open"
- 3 Click on "Import"

The user management data will be saved to the power source.

---

## **CENTRUM**

For activating a CENTRUM server  
(CENTRUM = Central User Management)

- 1 Activate CENTRUM server
- 2 In the input field, enter the domain name or IP address of the server where Central User Management has been installed.

A valid DNS server must be configured in the power source network settings if using a domain name.

- 3 Click the "Verify server" button

This checks the availability of the specified server.

- 4 Save changes

# Overview

---

## Overview

In the overview entry, welding system components and options are displayed with all available information, e.g. firmware version, item number, serial number, production date, etc.

---

## Expanding / reducing all groups



Clicking on the button "Expand all groups" displays further details for the individual system components.

Power source example:

- TT/MW Smart: Item number  
BCU1-COM: Item number, version, serial number, production date  
Bootloader: Version  
Image: Version  
Licences: ...
- SC2: Item number  
Firmware: Version
- ...



Clicking on the button "Reduce all groups" hides the details for the system components.

---

## Export component overview as ...



Click the "XML" button to create an XML file of the system component details. This XML file can either be opened or saved.

# Update

---

## Update

The power source firmware can be updated in the "Update" entry.

The current version of the firmware on your power source is displayed.



The update file can be downloaded via the following link:  
<https://www.fronius.com/iwave-downloads>

### To update the power source firmware:

- 1 Organise and save the update file
- 2 Click on "Search update file"
- 3 Select and open the update file

The selected update file is displayed on the power source SmartManager under "Update file".

Click on "Update"

A progress bar is displayed above the update process.  
When this reaches 100%, you will be prompted to restart the power source.



SmartManager is not available during the restart.  
After the restart, SmartManager may not be available any more.  
If you select "No", the new software functions are activated when you next switch the device on/off.

- 4 To restart the power source, click on "Yes"

The power source restarts; the display goes black for a short time.  
The Fronius logo is shown on the power source display during the restart.

Once the update has been completed successfully, a confirmation and the current firmware version are displayed.

- 5 You can now log on to SmartManager again

# Function Packages

---

## Function packages

In the Function Packages entry, the function packages present on the power source are displayed.  
New function packages can be uploaded.

---

## Installing a function package

- 1 Organise and save a function package
- 2 Click on "Search function package file"
- 3 Select the desired function package file (\*.xml)
- 4 Click on "Open"

The selected function package file is displayed on the power source SmartManager under "Install function package".

- 5 Click on "Install function package"

Once the function package has been successfully installed, a confirmation to this effect is displayed.

# Screenshot

---

## Screenshot

In the Screenshot entry, a digital image of the power source display can be created at any time, irrespective of the navigation or set values.

**1** Click on "Create screenshot" to capture a screenshot of the display

A screenshot of the currently displayed settings is created.

Different functions are available for saving the screenshot depending on the browser used; the display may vary.

# **Troubleshooting and maintenance**





# Troubleshooting

## General

The digital power sources are equipped with an intelligent safety system. This means that apart from the fuse for the coolant pump, it has been possible to dispense with fuses entirely. After a possible malfunction or error has been remedied, the power source can be put back into normal operation again without any fuses having to be replaced.

## Safety

### **WARNING!**

#### **Danger from incorrect operation and work that is not carried out properly.**

This can result in serious personal injury and damage to property.

- ▶ All the work and functions described in this document must only be carried out by technically trained and qualified personnel.
- ▶ Read and understand this document in full.
- ▶ Read and understand all safety rules and user documentation for this device and all system components.

### **WARNING!**

#### **Danger from electrical current.**

This can result in serious personal injury and damage to property.

- ▶ Before starting work, switch off all devices and components involved and disconnect them from the grid.
- ▶ Secure all devices and components involved so they cannot be switched back on.
- ▶ After opening the device, use a suitable measuring instrument to check that electrically charged components (such as capacitors) have been discharged.

### **WARNING!**

#### **Danger due to insufficient ground conductor connection.**

This can result in serious personal injury and damage to property.

- ▶ The housing screws provide a suitable ground conductor connection for grounding the housing.
- ▶ The housing screws must not under any circumstances be replaced by other screws without a reliable ground conductor connection.

## Power source - troubleshooting

### **Power source does not function**

Mains switch is on, but indicators are not lit up

Cause: There is a break in the mains lead; the mains plug is not plugged in

Remedy: Check the mains lead, ensure that the mains plug is plugged in

Cause: Mains socket or mains plug faulty

Remedy: Replace faulty parts

Cause: Mains fuse protection

Remedy: Change the mains fuse protection

---

**No welding current**

Mains switch is ON, overtemperature indicator is lit up

Cause: Overload

Remedy: Check duty cycle

Cause: Thermostatic safety cut-out has tripped

Remedy: Wait until the power source automatically comes back on after the end of the cooling phase

Cause: The fan in the power source is faulty

Remedy: Contact After-Sales Service

---

**No welding current**

Mains switch is on, indicators are lit up

Cause: Grounding (earthing) connection is incorrect

Remedy: Check the grounding (earthing) connection and terminal for correct polarity

Cause: There is a break in the current cable in the welding torch

Remedy: Replace welding torch

---

**Nothing happens when the torch trigger is pressed**

Mains switch is on, indicators are lit up

Cause: The control plug is not plugged in

Remedy: Plug in the control plug

Cause: Welding torch or welding torch control line is faulty

Remedy: Replace welding torch

---

**No protective gas shield**

All other functions are OK

Cause: Gas cylinder is empty

Remedy: Change the gas cylinder

Cause: Gas pressure regulator is faulty

Remedy: Change the gas pressure regulator

Cause: Gas hose is not fitted or is damaged

Remedy: Fit or change the gas hose

Cause: Welding torch is faulty

Remedy: Change the welding torch

Cause: Gas solenoid valve is faulty

Remedy: Contact After-Sales Service

---

**Poor weld properties**

Cause: Incorrect welding parameters

Remedy: Check the settings

Cause: Grounding (earthing) connection is incorrect

Remedy: Check the grounding (earthing) connection and terminal for correct polarity

---

**Welding torch becomes very hot**

Cause: Welding torch is inadequately dimensioned

Remedy: Observe the duty cycle and loading limits

Cause: Only on water-cooled systems: inadequate coolant flow

Remedy: Check coolant level, flow rate, contamination, etc.;  
coolant pump blocked: use a screwdriver - placed on the bushing - to turn  
the coolant pump shaft

Cause: Only on water-cooled systems: The "Cooling unit operating mode" setup  
parameter is set to "Off".

Remedy: In the Setup menu, change the parameter "Cooling unit operating mode" to  
"eco", "On" or "auto" under the component settings.

---

# Care, maintenance and disposal

---

## General

Under normal operating conditions, the power source requires only a minimum of care and maintenance. However, it is vital to observe some important points to ensure it remains in a usable condition for many years.

---

## Safety

### **WARNING!**

#### **Danger from incorrect operation and work that is not carried out properly.**

This can result in serious personal injury and damage to property.

- ▶ All the work and functions described in this document must only be carried out by technically trained and qualified personnel.
  - ▶ Read and understand this document in full.
  - ▶ Read and understand all safety rules and user documentation for this device and all system components.
- 

### **WARNING!**

#### **Danger from electrical current.**

This can result in serious personal injury and damage to property.

- ▶ Before starting work, switch off all devices and components involved and disconnect them from the grid.
  - ▶ Secure all devices and components involved so they cannot be switched back on.
  - ▶ After opening the device, use a suitable measuring instrument to check that electrically charged components (such as capacitors) have been discharged.
- 

### **WARNING!**

#### **Danger due to insufficient ground conductor connection.**

This can result in serious personal injury and damage to property.

- ▶ The housing screws provide a suitable ground conductor connection for grounding the housing.
  - ▶ The housing screws must not under any circumstances be replaced by other screws without a reliable ground conductor connection.
- 

## At every start-up

- Check mains plug, mains cable, welding torch, interconnecting hosepack and ground earth connection for damage
- Check that the device has an all-round clearance of 0.5 m (1 ft. 8 in.) to ensure that cooling air can flow in and out freely

### **NOTE!**

**The air inlets and outlets must never be covered, not even partially.**

---

## Every 2 months

- If present: clean air filter

---

**Every 6 months** **CAUTION!****Danger due to the effect of compressed air.**

This can result in damage to property.

- ▶ Do not bring the air nozzle too close to electronic components.
- 

- 1 Dismantle device side panels and clean inside of device with dry, reduced compressed air
- 2 If a lot of dust has accumulated, clean the cooling air ducts

 **WARNING!****An electric shock can be fatal!**

Risk of electric shock from improperly connected ground cables and equipment grounds.

- ▶ When reassembling the side panels, make sure that grounding cables and equipment grounds are properly connected.
- 

---

**Disposal**

Dispose of in accordance with the applicable national and local regulations.



# Appendix





# Average consumption values during welding

**Average shield-  
ing gas con-  
sumption during  
TIG welding**

Gas nozzle size	4	5	6	7	8	10
Average con- sumption	6 l/min	8 l/min	10 l/min	12 l/min	12 l/min	15 l/min

# Technical data

## Overview with critical raw materials, year of production of the device

### Overview with critical raw materials:

An overview of which critical raw materials are contained in this device can be found at the following Internet address.

[www.fronius.com/en/about-fronius/sustainability](http://www.fronius.com/en/about-fronius/sustainability).

### To calculate the year of production of the device:

- Each device is provided with a serial number
- The serial number consists of 8 digits - for example 28020099
- The first two digits give the number from which the year of production of the device can be calculated
- This figure minus 11 gives the year of production
  - For example: Serial number = 28020065, calculation of the year of production = 28 - 11 = 17, year of production = 2017

## Special voltages

 **CAUTION!**

**An inadequately dimensioned electrical installation can cause serious damage.**

- ▶ The mains lead and its fuse must be dimensioned accordingly. The technical data shown on the rating plate applies.

## Versions of the appliance

Depending on the ending of the device name, the devices are available in the following versions:

/EF	Device with fitted European mains cable
/np	Device with fitted mains cable without plug
/MV/B	Multi Voltage device with mounted US mains cable
/MV/np	Multi Voltage device with mounted US mains cable without plug

## iWave 190i AC/DC

Mains voltage $U_1$	1 x 230 V
Mains voltage tolerance	± 15%
Grid frequency	50/60 Hz
Mains fuse protection (slow-blow)	16 A
Mains connection <sup>1)</sup>	$Z_{\max}$ on PCC <sup>3)</sup> = 315 mOhm
Cos phi	0.99
Primary circuit $S_{1\max}$ (at 100% ED <sup>2)</sup> )	
TIG	2.7 kVA
Electrode	3.55 kVA
Welding current range	
TIG	3 - 190 A

Electrode	10 - 170 A
Welding current at	
10 min/40°C (104°F) 35% ED <sup>2)</sup>	190 A <sup>4)</sup> 170 A <sup>5)</sup>
10 min/40°C (104°F) 60% ED <sup>2)</sup>	160 A <sup>4)</sup> 140 A <sup>5)</sup>
10 min/40°C (104°F) 100% ED <sup>2)</sup>	140 A <sup>4)</sup> 120 A <sup>5)</sup>
Open circuit voltage	100 V
Working voltage	
TIG	10.1 - 17.6 V
Electrode	20.4 - 26.8 V
Striking voltage (U <sub>p</sub> )	9.6 kV
The arc striking voltage is suitable for manual operation.	
Degree of protection	IP 23
Type of cooling	AF
Overvoltage category	III
Pollution degree according to IEC 60664	3
EMC device class	A <sup>6)</sup>
Insulation class	B
Dimensions L/W/H (with handle)	558/210/369 mm / 22.0/8.3/14.5 in.
Weight	17.0 kg / 37.5 lb.
Mark of conformity	S, CE
Max. shielding gas pressure	6 bar / 87.02 psi
Noise emission (L <sub>WA</sub> )	68 dB(A)
Idle state power consumption at 230 V	23.8 W
Power source efficiency at 170 A / 26.8 V	84%

**iWave 190i  
AC/DC /MV**

Mains voltage $U_1$	1 x 120 / 230 V
Mains voltage tolerance	± 15%
Grid frequency	50/60 Hz
Mains fuse protection (slow-blow)	16 A ( $U_1 = 230$ V) 20 A ( $U_1 = 120$ V)
Mains connection <sup>1)</sup>	$Z_{\max}$ on PCC <sup>3)</sup> = 315 mOhm
Cos phi	0.99
Primary circuit $S_{1\max}$ (at 100% ED <sup>2)</sup> )	
TIG	2.7 kVA ( $U_1 = 230$ V) 1.84 kVA ( $U_1 = 120$ V)
Electrode	3.55 kVA ( $U_1 = 230$ V) 1.94 kVA ( $U_1 = 120$ V)
Welding current range	
TIG	3 - 190 A
Electrode	10 - 170 A
Welding current at	
10 min/40°C (104°F) 35% ED <sup>2)</sup>	190 A <sup>4)</sup> ( $U_1 = 230$ V) 150 A <sup>4)</sup> ( $U_1 = 120$ V) 170 A <sup>5)</sup> ( $U_1 = 230$ V) 100 A <sup>5)</sup> ( $U_1 = 120$ V)
10 min/40°C (104°F) 60% ED <sup>2)</sup>	160 A <sup>4)</sup> ( $U_1 = 230$ V) 120 A <sup>4)</sup> ( $U_1 = 120$ V) 140 A <sup>5)</sup> ( $U_1 = 230$ V) 80 A <sup>5)</sup> ( $U_1 = 120$ V)
10 min/40°C (104°F) 100% ED <sup>2)</sup>	140 A <sup>4)</sup> ( $U_1 = 230$ V) 100 A <sup>4)</sup> ( $U_1 = 120$ V) 120 A <sup>5)</sup> ( $U_1 = 230$ V) 70 A <sup>5)</sup> ( $U_1 = 120$ V)
Open circuit voltage	100 V
Working voltage	
TIG	10.1 - 17.6 V
Electrode	20.4 - 26.8 V
Striking voltage ( $U_p$ )	9.6 kV
The arc striking voltage is suitable for manual operation.	
Degree of protection	IP 23
Type of cooling	AF
Overvoltage category	III
Pollution degree according to IEC 60664	3
EMC device class	A <sup>6)</sup>

Insulation class	B
Dimensions L/W/H (with handle)	558/210/369 mm / 22.0/8.3/14.5 in.
Weight	16.5 kg / 36.4 lb.
Mark of conformity	S, CE, CSA <sup>7)</sup>
Max. shielding gas pressure	6 bar / 87.02 psi
Noise emission (L <sub>WA</sub> )	68 dB(A)
Idle state power consumption at 230 V	23.8 W
Power source efficiency at 170 A / 26.8 V	84%

**iWave 230i  
AC/DC**

Mains voltage $U_1$	1 x 230 V
Mains voltage tolerance	± 15%
Grid frequency	50/60 Hz
Mains fuse protection (slow-blow)	16 A
Mains connection <sup>1)</sup>	$Z_{\max}$ on PCC <sup>3)</sup> = 273 mOhm
Cos phi	0.99
Primary circuit $S_{1\max}$ (at 100% ED <sup>2)</sup> )	
TIG	3540 VA
Electrode	3540 VA
Welding current range	
TIG	3 - 230 A
Electrode	10 - 190 A
Welding current at	
10 min/40°C (104°F) 35% ED <sup>2)</sup>	230 A <sup>4)</sup> 190 A <sup>5)</sup>
10 min/40°C (104°F) 60% ED <sup>2)</sup>	195 A <sup>4)</sup> 150 A <sup>5)</sup>
10 min/40°C (104°F) 100% ED <sup>2)</sup>	165 A <sup>4)</sup> 120 A <sup>5)</sup>
Open circuit voltage	100 V
Working voltage	
TIG	10.1 - 19.2 V
Electrode	20.4 - 27.6 V
Striking voltage ( $U_p$ )	9.6 kV
	The arc striking voltage is suitable for manual operation.
Degree of protection	IP 23
Type of cooling	AF
Overvoltage category	III
Pollution degree according to IEC 60664	3
EMC device class	A <sup>6)</sup>
Insulation class	B
Dimensions L/W/H (with handle)	558/210/369 mm / 22.0/8.3/14.5 in.
Weight	17.0 kg / 37.5 lb.
Mark of conformity	S, CE
Max. shielding gas pressure	6 bar / 87.02 psi
Noise emission ( $L_{WA}$ )	68 dB(A)
Idle state power consumption at 230 V	23.7 W
Power source efficiency at 190 A / 27.6 V	84%

**iWave 230i  
AC/DC /MV**

Mains voltage $U_1$	1 x 120 / 230 V
Mains voltage tolerance	± 15%
Grid frequency	50/60 Hz
Mains fuse protection (slow-blow)	16 A ( $U_1 = 230$ V) 20 A ( $U_1 = 120$ V)
Mains connection <sup>1)</sup>	$Z_{\max}$ on PCC <sup>3)</sup> = 273 mOhm
Cos phi	0.99
Primary circuit $S_{1\max}$ (at 100% ED <sup>2)</sup> )	
TIG	3540 VA ( $U_1 = 230$ V) 2390 VA ( $U_1 = 120$ V)
Electrode	3540 VA ( $U_1 = 230$ V) 2410 VA ( $U_1 = 120$ V)
Welding current range	
TIG	3 - 230 A
Electrode	10 - 190 A
Welding current at	
10 min/40°C (104°F) 35% ED <sup>2)</sup>	230 A <sup>4)</sup> ( $U_1 = 230$ V) 170 A <sup>4)</sup> ( $U_1 = 120$ V) 190 A <sup>5)</sup> ( $U_1 = 230$ V) 120 A <sup>5)</sup> ( $U_1 = 120$ V)
10 min/40°C (104°F) 60% ED <sup>2)</sup>	195 A <sup>4)</sup> ( $U_1 = 230$ V) 140 A <sup>4)</sup> ( $U_1 = 120$ V) 150 A <sup>5)</sup> ( $U_1 = 230$ V) 105 A <sup>5)</sup> ( $U_1 = 120$ V)
10 min/40°C (104°F) 100% ED <sup>2)</sup>	165 A <sup>4)</sup> ( $U_1 = 230$ V) 120 A <sup>4)</sup> ( $U_1 = 120$ V) 120 A <sup>5)</sup> ( $U_1 = 230$ V) 85 A <sup>5)</sup> ( $U_1 = 120$ V)
Open circuit voltage	100 V
Working voltage	
TIG	10.1 - 19.2 V
Electrode	20.4 - 27.6 V
Striking voltage ( $U_p$ )	9.6 kV
The arc striking voltage is suitable for manual operation.	
Degree of protection	IP 23
Type of cooling	AF
Overvoltage category	III
Pollution degree according to IEC 60664	3
EMC device class	A <sup>6)</sup>

Insulation class	B
Dimensions L/W/H (with handle)	558/210/369 mm / 22.0/8.3/14.5 in.
Weight	16.5 kg / 36.4 lb.
Mark of conformity	S, CE, CSA <sup>7)</sup>
Max. shielding gas pressure	6 bar / 87.02 psi
Noise emission (L <sub>WA</sub> )	68 dB(A)
Idle state power consumption at 230 V	23.7 W
Power source efficiency at 190 A / 27.6 V	84%



**iWave 230i DC**

Mains voltage $U_1$	1 x 230 V
Mains voltage tolerance	± 15%
Grid frequency	50/60 Hz
Mains fuse protection (slow-blow)	16 A
Mains connection <sup>1)</sup>	$Z_{\max}$ on PCC <sup>3)</sup> = 273 mOhm
Cos phi	0.99
Primary circuit $S_{1\max}$ (at 100% ED <sup>2)</sup> )	
TIG	3.36 kVA
Electrode	3.59 kVA
Welding current range	
TIG	3 - 230 A
Electrode	10 - 190 A
Welding current at	
10 min/40°C (104°F) 35% ED <sup>2)</sup>	190 A <sup>5)</sup>
10 min/40°C (104°F) 45% ED <sup>2)</sup>	230 A <sup>4)</sup>
10 min/40°C (104°F) 60% ED <sup>2)</sup>	205 A <sup>4)</sup> 155 A <sup>5)</sup>
10 min/40°C (104°F) 100% ED <sup>2)</sup>	170 A <sup>4)</sup> 125 A <sup>5)</sup>
Open circuit voltage	97 V
Working voltage	
TIG	10.1 - 19.2 V
Electrode	20.4 - 27.6 V
Striking voltage ( $U_p$ )	9.6 kV
	The arc striking voltage is suitable for manual operation.
Degree of protection	IP 23
Type of cooling	AF
Overvoltage category	III
Pollution degree according to IEC 60664	3
EMC device class	A <sup>6)</sup>
Insulation class	B
Dimensions L/W/H (with handle)	558/210/369 mm / 22.0/8.3/14.5 in.
Weight	16.4 kg / 36.2 lb.
Mark of conformity	S, CE
Max. shielding gas pressure	6 bar / 87.02 psi
Noise emission ( $L_{WA}$ )	68 dB(A)
Idle state power consumption at 230 V	24.4 W

---

Power source efficiency at  
190 A / 27.6 V

---

87%

**iWave 230i  
DC /MV**

Mains voltage $U_1$	1 x 120 / 230 V
Mains voltage tolerance	± 15%
Grid frequency	50/60 Hz
Mains fuse protection (slow-blow)	16 A ( $U_1 = 230$ V) 20 A ( $U_1 = 123$ V)
Mains connection <sup>1)</sup>	$Z_{\max}$ on PCC <sup>3)</sup> = 273 mOhm
Cos phi	0.99
Primary circuit $S_{1\max}$ (at 100% ED <sup>2)</sup> )	
TIG	3.36 kVA ( $U_1 = 230$ V) 2.38 kVA ( $U_1 = 120$ V)
Electrode	3.59 kVA ( $U_1 = 230$ V) 2.32 kVA ( $U_1 = 120$ V)
Welding current range	
TIG	3 - 230 A
Electrode	10 - 190 A
Welding current at	
10 min/40°C (104°F) 35% ED <sup>2)</sup>	190 A <sup>5)</sup> ( $U_1 = 230$ V) 120 A <sup>5)</sup> ( $U_1 = 120$ V)
10 min/40°C (104°F) 45% ED <sup>2)</sup>	230 A <sup>4)</sup> ( $U_1 = 230$ V) 170 A <sup>4)</sup> ( $U_1 = 120$ V)
10 min/40°C (104°F) 60% ED <sup>2)</sup>	205 A <sup>4)</sup> ( $U_1 = 230$ V) 155 A <sup>4)</sup> ( $U_1 = 120$ V) 155 A <sup>5)</sup> ( $U_1 = 230$ V) 105 A <sup>5)</sup> ( $U_1 = 120$ V)
10 min/40°C (104°F) 100% ED <sup>2)</sup>	170 A <sup>4)</sup> ( $U_1 = 230$ V) 130 A <sup>4)</sup> ( $U_1 = 120$ V) 125 A <sup>5)</sup> ( $U_1 = 230$ V) 85 A <sup>5)</sup> ( $U_1 = 120$ V)
Open circuit voltage	97 V
Working voltage	
TIG	10.1 - 19.2 V
Electrode	20.4 - 27.6 V
Striking voltage ( $U_p$ )	9.6 kV
The arc striking voltage is suitable for manual operation.	
Degree of protection	IP 23
Type of cooling	AF
Overvoltage category	III
Pollution degree according to IEC 60664	3
EMC device class	A <sup>6)</sup>

Insulation class	B
Dimensions L/W/H (with handle)	558/210/369 mm / 22.0/8.3/14.5 in.
Weight	15.9 kg / 35.1 lb.
Mark of conformity	S, CE, CSA <sup>7)</sup>
Max. shielding gas pressure	6 bar / 87.02 psi
Noise emission (L <sub>WA</sub> )	68 dB(A)
Idle state power consumption at 230 V	24.4 W
Power source efficiency at 190 A / 27.6 V	87%

**Explanation of footnotes**

- 1) Connected to public grids with 230 / 400 V and 50 Hz
- 2) ED = Duty cycle
- 3) PCC = interface to the public grid
- 4) TIG welding
- 5) Manual metal arc welding
- 6) An emission class A device is not designed for use in residential areas supplied with power from a public low-voltage grid.  
The electromagnetic compatibility can be influenced by conducted or radiated radio frequencies.
- 7) CSA certification only for /MV/B devices

**Radio parameters** Conformity with Directive 2014/53 / EU - Radio Equipment Directive (RED)

The following table contains the frequency ranges and maximum HF transmission power used by Fronius wireless products sold in the EU in accordance with Article 10.8 (a) and 10.8 (b) of the RED.

Frequency range Channels used Power	Modulation
2412 - 2462 MHz Channel: 1 - 11 b ,g, n HT20 Channel: 3 - 9 HT40 < 16 dBm	802.11b: DSSS (1Mbps DBPSK, 2Mbps DQPSK, 5.5/11Mbps CCK)  802.11g: OFDM (6/9Mbps BPSK, 12/18Mbps QPSK, 24/36Mbps 16-QAM, 48/54Mbps 64- QAM)  802.11n: OFDM (6.5Mbps BPSK, 13/19 Mbps QPSK, 26/39 Mbps 16-QAM, 52/58.5/65Mbps 64- QAM)
13.56 MHz -14.6 dB $\mu$ A/m at 10 m	Functions: R/W, card emulation and P2P  Protocol standards: ISO 14443A/B, ISO15693, ISO18092, NFCIP-2,  Data rate: 848 kbps  Reader/Writer, Card Emulation, Peer to Peer Modes
2402 - 2482 MHz 0 - 39 < 4 dBm	GFSK





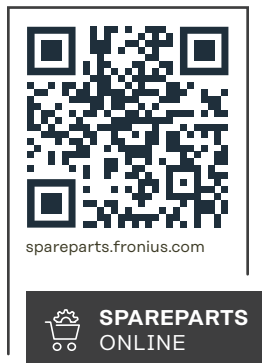

**Fronius International GmbH**

Froniusstraße 1  
4643 Pettenbach  
Austria  
[contact@fronius.com](mailto:contact@fronius.com)  
[www.fronius.com](http://www.fronius.com)

Under [www.fronius.com/contact](http://www.fronius.com/contact) you will find the addresses of all Fronius Sales & Service Partners and locations.