

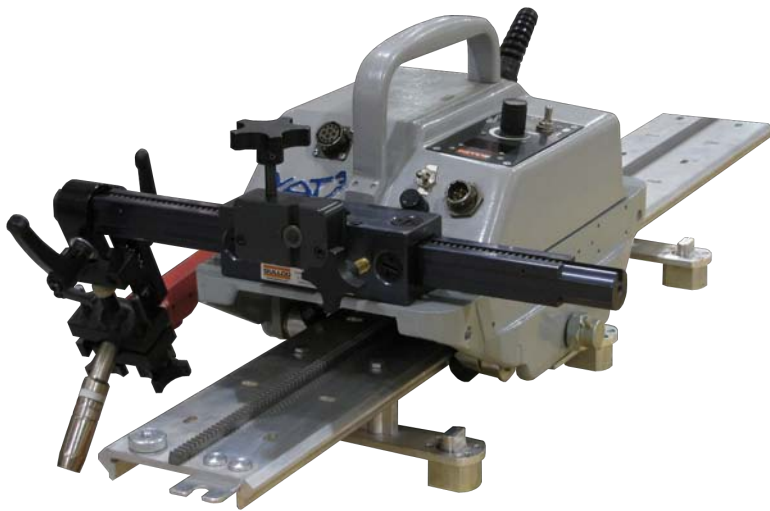

WELDING AND CUTTING CARRIAGE - KAT® FOR RIGID TRACK

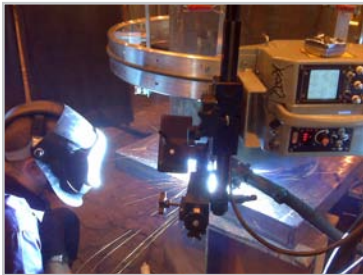

The Gullco Rigid KAT® is used throughout the world to automate a wide variety of welding and cutting operations. It is a durable, reliable precision travel carriage designed for use on rigid track which enables it to operate along any plane. The rigid track can be used in straight sections or can be formed for use on curved surfaces. Gullco manufactures several systems and accessories designed for use with the Rigid KAT® making it one of the most versatile pieces of welding and cutting automation equipment available in the industry.



MULTI-PASS WELDS

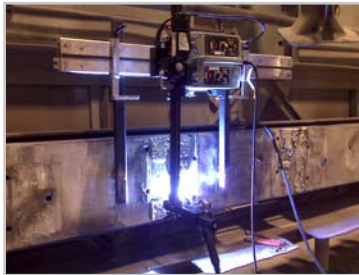

CLADDING OVERLAY



ALL POSITION

Reliable automation that improves quality and reduces costs in welding and cutting operations

ALL POSITION - PRECISE CONTROL - VARIABLE SPEED

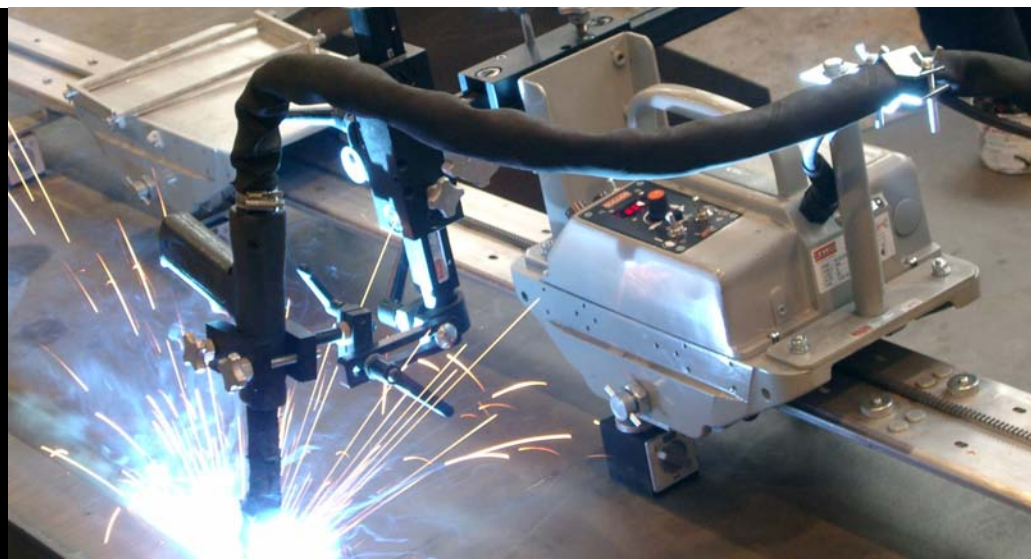



AUTOMATED WELDING SYSTEM KAT® RIGID TRACK

The Gullco Rigid KAT® carriage is used throughout the world to automate and improve the quality and efficiency of single or multiple “head” welding and cutting operations. Welding guns or cutting torches mounted on the KAT® carriage move along Gullco standard or deep section track at precisely controlled speeds along the desired path in forward or reverse direction. Gullco’s Rigid KAT® carriage enables welding guns or cutting torches to operate with precise motion from start to finish regardless of the number of passes or the work pieces involved, improving the quality, efficiency and repeatability of the process. Poor or awkward accessibility, operator fatigue, or inconsistent workmanship are eliminated. This unit is designed for operation on flat or curved surfaces as the track can be used in straight sections or roll formed to follow the contour of the work piece. The self-aligning wheel system of the carriage grips the top and bottom of the track, enabling it to travel along any plane. The adjustable wheel assembly keeps the carriage snug to the track, while allowing it to be easily mounted and removed from the track at any point. The positive drive of the KAT® is obtained from a uniquely designed rack and pinion system, driven by a low voltage permanent magnet motor and gearhead power unit assembly.



AUTO-WELD CARRIAGE SYSTEM

The KAT® Auto-Weld Carriage option enables a wide variety of automated welding and cutting overlay cycles that can be repeatedly performed. The GSP control in this unit controls travel direction/speed and length of travel path and synchronizes them with precise weld start and weld stop settings. This travel carriage is pre-drilled for mounting



Auto-Weld accessories (sold separately). It is ideal for stitch welding and seam welding applications where repeatability is desired. The reliability and precision of this automated welding and cutting system reduces cost, adds efficiency and improves quality.

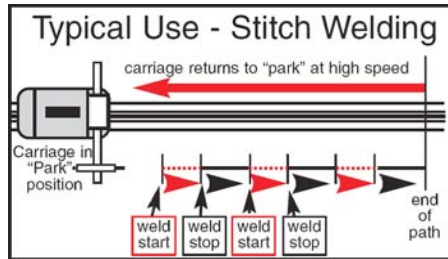

A

CLADDING / OVERLAY SYSTEM

The Indexing option Rigid KAT® uses a GSP control that combines control of the carriage movement and start/stop parameters with precise indexing of the torch at the end of the path. This fully automates and increases the efficiency of overlay welding operations, flame spray work, hard facing etc. At the end of the path the travel carriage



automatically stops and reverses direction while at the same time indexing the gun/torch. It can be programmed to weld or not weld during indexing. Carriage is pre-drilled or quick mounting of the indexing unit (sold separately).

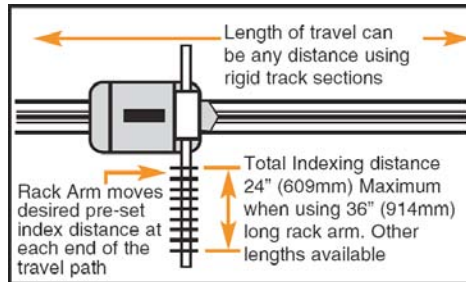

I

OSCILLATION WELDING SYSTEM

The oscillator is available with a linear, pendulum, tangential or step (square pattern) motion to the welding gun with adjustable motorized stroke width, infinitely variable stroke speed adjustment, three independent position dwell times, motorized centre line positioning and automatic wire feed start and travel start/stop interface.

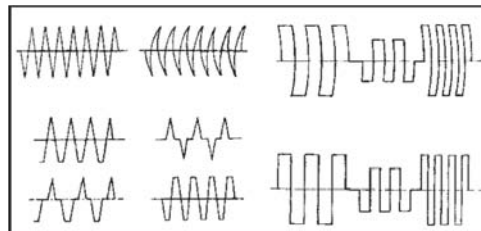

O

The Gullco Standard Platform range of controls have switching for forward / neutral / reverse, run / stop, Manual / Auto & program variable increment/decrement (where applicable) and a rotary encoder for speed control. This micro-processor based, 24 volt DC motor control can be supplied to provide a variety of "optional" functions such as indexing, weld oscillation and auto-weld. The selected "option" function and carriage travel speed/ direction are directed by a single GSP control. This ensures high levels of accuracy, quality and reliability.

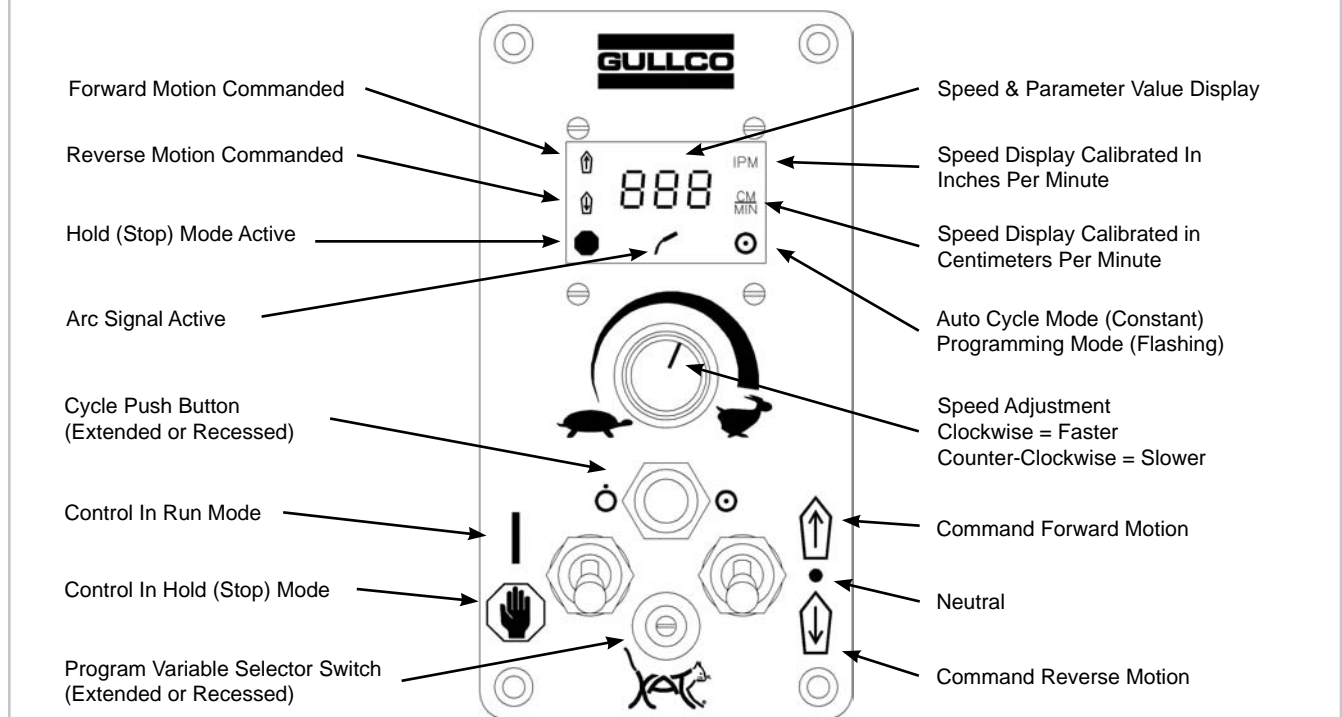

Select a speed, voltage and option to configure a KAT® specifically suited to your needs

GK-200- -

SPEED RANGES	
MODEL	SPEED RANGE
RL	0.5 to 16.4 IMP (1.2 to 41.6 cm/min)
RM	1 to 32.7 IPM (2.5 to 83.1 cm/min)
RH	2.7 to 88.4 IPM (6.7 to 224 cm/min)

VOLTAGES	
MODEL	INPUT SUPPLY
A	42 VAC
B	115 VAC
C	230 VAC

SPECIFICATIONS

Weight: 29 lbs (13 kg)
 Vertical Load Capacity: 100 lbs (45 kgs)
 Drive Motor: 24 VDC permanent magnet gear motor
 Supply Voltage: 42, 115, 230 VAC, single phase
 Complies With: CSA & CE Certification

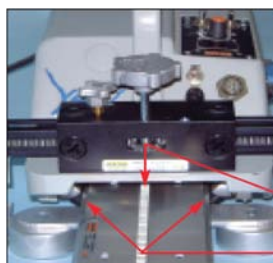
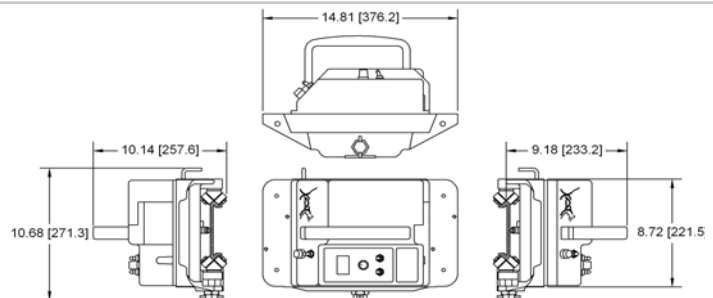

Unique Drive System and Wheel Assemblies Enable Travel in All Positions Including Overhead

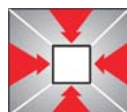

Positive drive rack and pinion system

Self-aligning wheel assemblies run on both top and bottom of track... enabling operation on any plane.

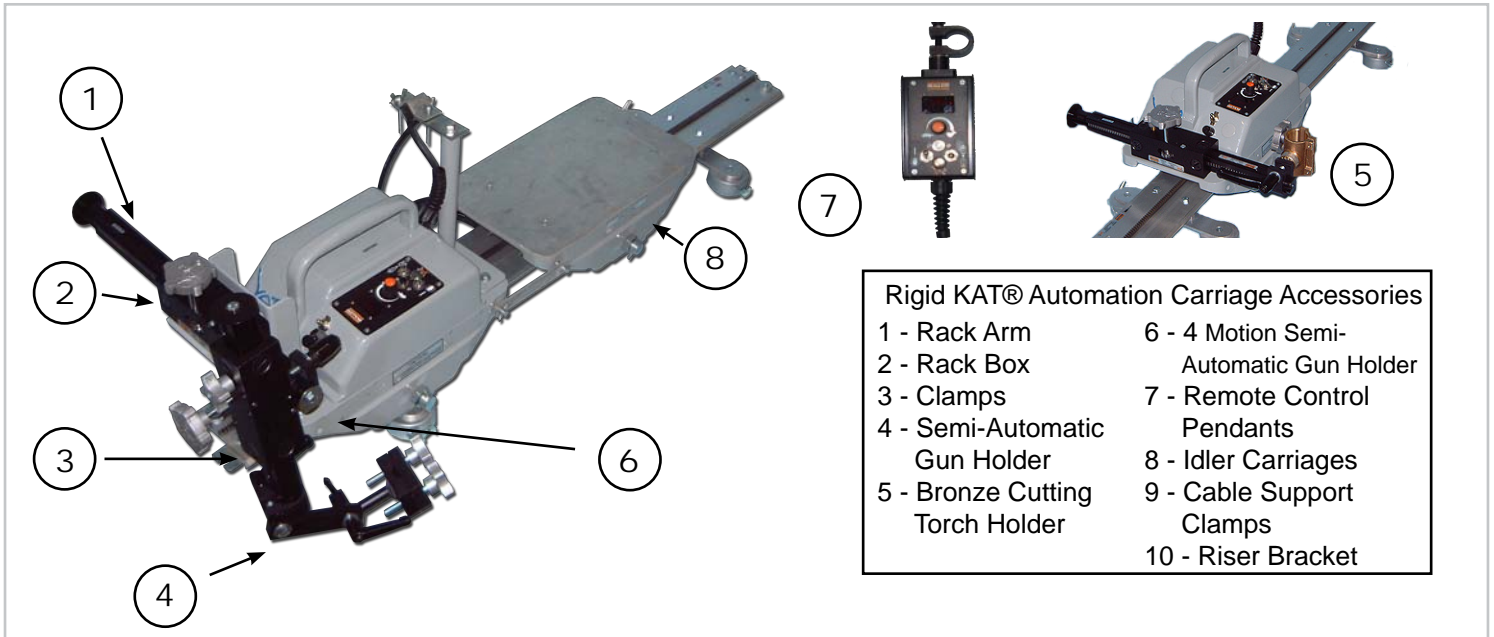

RIGID KAT® TRACK SYSTEMS

Gullco Rigid Track is made from precision extruded aluminum and a securely affixed steel rack. The interchangeable end design enables fast accurate joining of the track sections. Standard Track, used in most portable applications, is available in 48, 96 and 120 inch (1219, 2438 and 3048 mm) lengths and can be formed to suit the work contour. Deep Section Track is used in permanent, straight run applications. It is available in 60" and 120" (1524 and 3048mm) lengths. The track is securely mounted on ferrous materials using round or square magnet assemblies. Vacuum mount assemblies can be used on non-ferrous or ferrous materials.

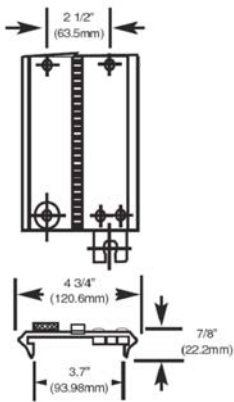

WEIGHT:
2 lbs/ft (3.0 kg/m)

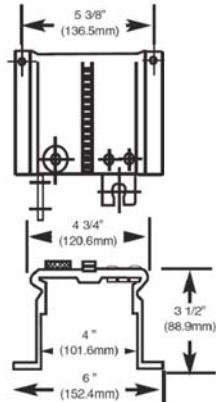

WEIGHT:
3 lbs/ft (4.5 kg/m)

TRACK MOUNTING DEVICES

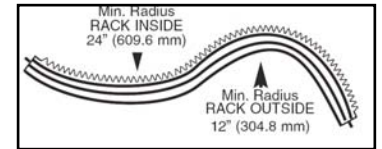

KAT, KBM, MOGGY, KATBAK & SAM are registered trademarks of Gullco Enterprises Limited

Distributed by:

SPECIFICATIONS ARE SUBJECT TO CHANGE WITHOUT NOTICE. ALL DIMENSIONS ARE NOMINAL

GULLCO		
CANADA - GULLCO INTERNATIONAL LIMITED	Phone: 905-953-4140	Fax: 905-953-4138 e-mail: sales@gullco.com
U.S.A - GULLCO INTERNATIONAL INC.	Phone: 440-439-8333	Fax: 440-439-3634 e-mail: ussales@gullco.com
EUROPE - GULLCO INTERNATIONAL (U.K.) LIMITED	Phone: +44 1257-253579	Fax: +44 1257-254629 e-mail: uksales@gullco.com
AUSTRALIA - GULLCO INTERNATIONAL PTY LIMITED	Phone: 61 (0)7 3348 5515	Fax: 61 (0)7 3348 5510 e-mail: ausales@gullco.com
INDIA - GULLCO INTERNATIONAL INDIA PVT LIMITED	Phone: 91-20-6526-0382	Fax: 91-20-2683-6656 e-mail: indsales@gullco.com
CHINA - GULLCO INTERNATIONAL SHANGHAI LIMITED	Phone: +8621-50460341	Fax: +8621-50463554 e-mail: c.zhang@gullco.com
SINGAPORE - GULLCO INTERNATIONAL LIMITED	Phone: +65-9385-4468	e-mail: benny.lim@gullco.com
LATIN AMERICA - GULLCO INTERNATIONAL LIMITED	Phone: 55-11-99485-1336	e-mail: rogerio.macedo@gullco.com
Stuch GmbH & Co. KG Schweisstechnik - GERMANY	Phone: (02 03) 72 94 95	Fax: (02 03) 72 94 96 e-mail: info@stuch-schweisstechnik.de

WELDING AND CUTTING CARRIAGE - KAT® FOR FLEXIBLE TRACK



The Gullco Flexible KAT® is used throughout the world to automate a wide variety of welding and cutting operations.

It is a durable, reliable precision travel carriage designed for use on flexible track which enables it to operate on straight or curved surfaces along any position.

Gullco manufactures several systems and accessories designed for use with the Flex KAT® making it one of the most versatile pieces of welding/cutting automation equipment available.



MULTI-PASS WELDS

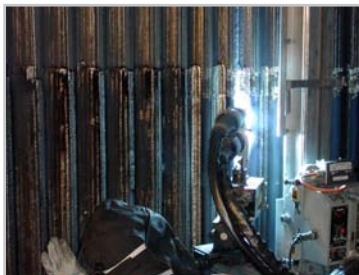

CLADDING OVERLAY



ALL POSITION

Reliable automation that improves quality and reduces costs in welding and cutting operations

ALL POSITION - PRECISE CONTROL - VARIABLE SPEED

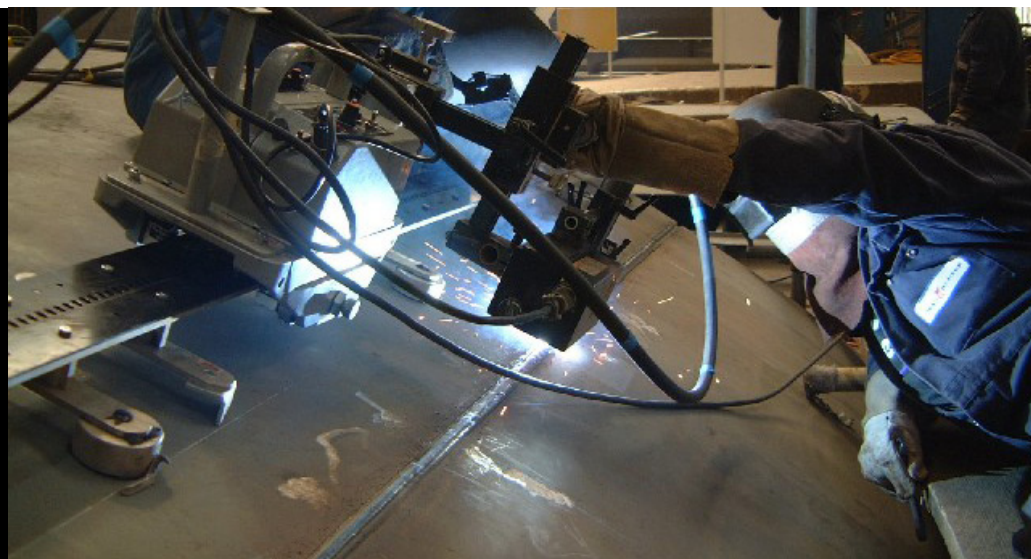



AUTOMATED WELDING SYSTEM KAT® FLEXIBLE TRACK

The Gullco Flex KAT® Carriage is used throughout the world to automate and improve the quality and efficiency of single or multiple "head" welding and cutting operations. Welding guns or cutting torches are mounted on the KAT® carriage as it moves along Gullco Flex Track at precisely controlled speeds along the desired path in forward or reverse direction. Gullco's Flex KAT® carriage enables welding guns or cutting torches to operate with precise motion from start to finish regardless of the number of passes or the work pieces involved. This improves the quality, efficiency and repeatability of the process. Poor or awkward accessibility, operator fatigue, or inconsistent workmanship are eliminated.

This unit is designed for operation on curved surfaces as the flexible track can be positioned to follow the contour of the work piece. The self-aligning wheel system of the carriage grips the top and bottom of the track, enabling it to travel along any plane. The adjustable wheel assembly keeps the carriage snug to the track, while allowing it to be easily mounted and removed from the track at any point. The positive drive of the KAT® is obtained from a uniquely designed sprocket that engages with slots in the track, driven by a low voltage permanent magnet motor and gear-head power unit assembly.



AUTO-WELD CARRIAGE SYSTEM

The KAT® Auto-Weld Carriage option enables a wide variety of automated welding and cutting overlay cycles that can be repeatedly performed. The GSP control in this unit controls travel direction and speed and length of travel path and synchronizes them with precise weld start and weld stop settings. This travel carriage is pre-drilled for mounting



Auto-Weld accessories (sold separately). It is ideal for stitch welding and seam welding applications where repeatability is desired. The reliability and precision of this automated welding and cutting system reduces cost, adds efficiency and improves quality.

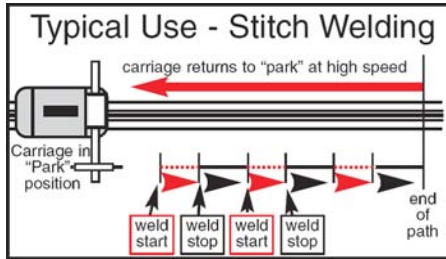

A

CLADDING / OVERLAY SYSTEM

The Indexing option Flex KAT® uses a GSP control that combines control of the carriage movement and start/stop parameters with precise indexing of the torch at the end of the path. This fully automates and increases the efficiency of overlay welding operations, flame spray work, hard facing etc. At the end of the path the travel carriage



automatically stops and reverses direction while at the same time indexing the gun/torch. It can be programmed to weld or not weld during indexing. Carriage is pre-drilled for quick mounting of the indexing unit (sold separately).

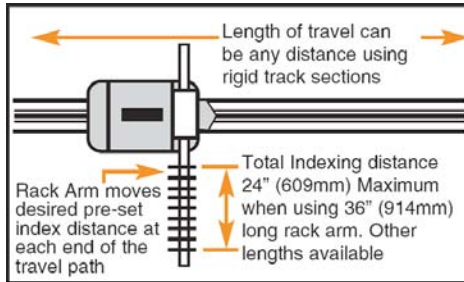

I

OSCILLATION WELDING SYSTEM

The oscillator is available with a linear, pendulum, tangential or step (square pattern) motion to the welding gun with adjustable motorized stroke width, infinitely variable stroke speed adjustment, three independent position dwell times, motorized centre line positioning and automatic wire feed start and travel start/stop interface.

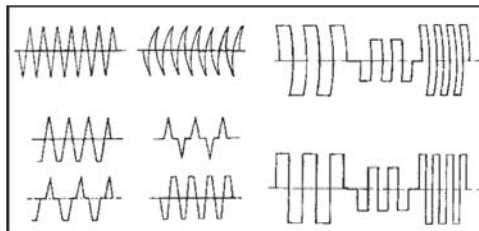

O

The Gullco Standard Platform range of controls have switching for forward / neutral / reverse, run / stop, Manual / Auto & program variable increment/decrement (where applicable) and a rotary encoder for speed control. This microprocessor based, 24 volt DC motor control can be supplied to provide a variety of "optional" functions such as indexing, weld oscillation and auto-weld. The selected "option" function and carriage travel speed/ direction are directed by a single GSP control. This ensures high levels of accuracy, quality and reliability.

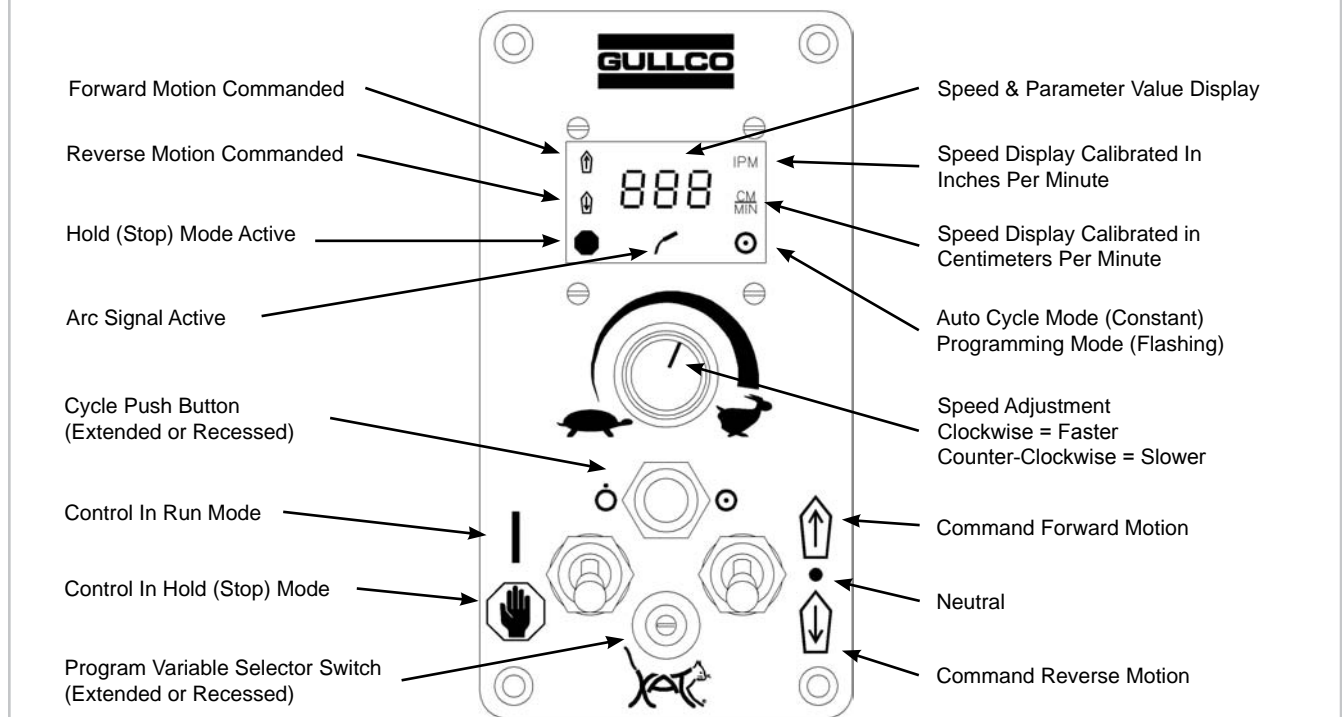

Select a speed, voltage and option to configure a KAT® specifically suited to your needs

GK-200- -

SPEED RANGES	
MODEL	SPEED RANGE
FL	0.8 to 25.8 IMP (2 to 65.4 cm/min)
FM	1.5 to 51.5 IPM (3.9 to 131 cm/min)
FH	4.2 to 139.1 IPM (10.6 to 353 cm/min)

VOLTAGES	
MODEL	INPUT SUPPLY
A	42 VAC
B	115 VAC
C	230 VAC

SPECIFICATIONS

Weight: 29 lbs (13 kg)
Vertical Load Capacity: 100 lbs (45 kgs)
Drive Motor: 24 VDC permanent magnet gear motor
Supply Voltage: 42, 115, 230 VAC, single phase 50/60 Hz., 200 Watts
Complies With: CSA & CE Certification

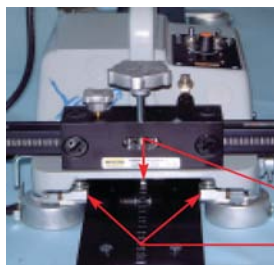
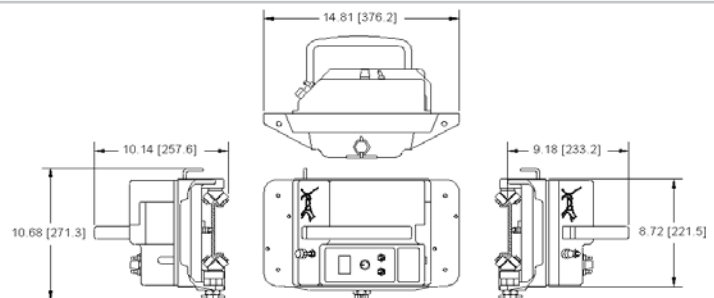

Unique Drive System and Wheel Assemblies Enable Travel in All Positions Including Overhead



Ball studded drive sprocket engages apertures in the track

Self-aligning wheel assemblies run on both top and bottom of the track... enabling operation on any plane.

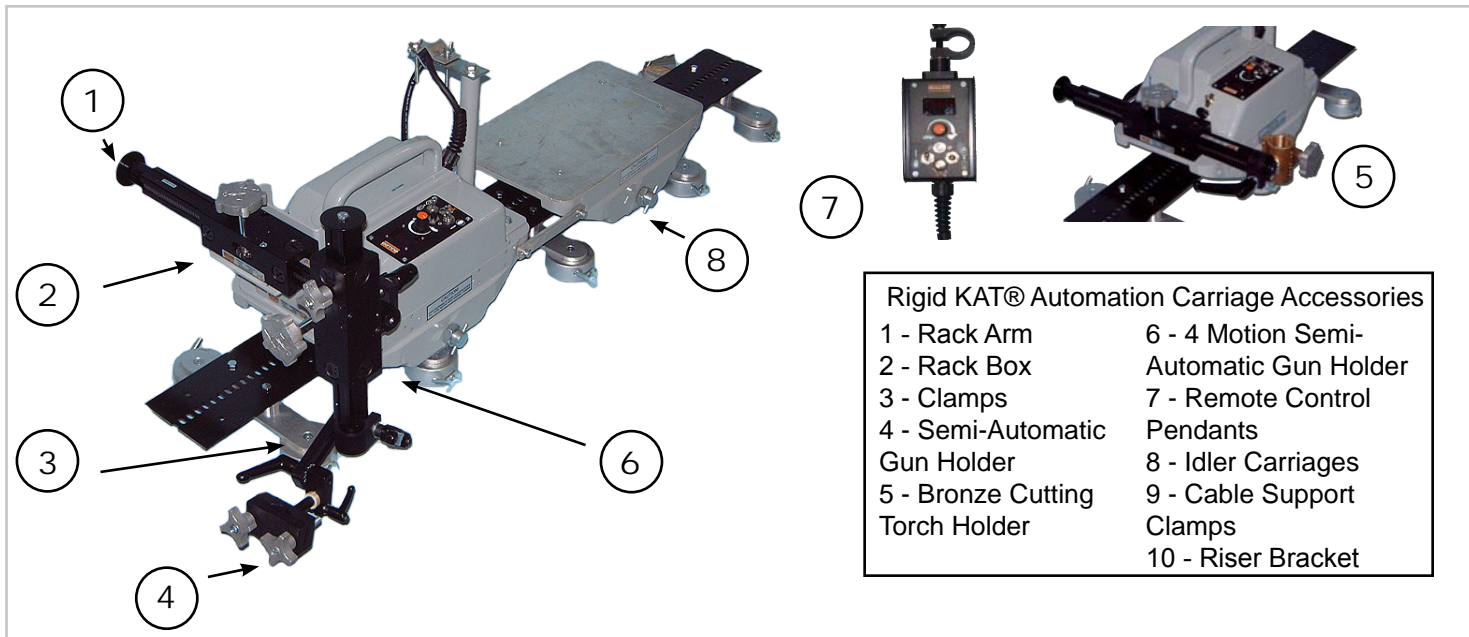

- Rigid KAT® Automation Carriage Accessories**
- | | |
|---------------------------------|--|
| 1 - Rack Arm | 6 - 4 Motion Semi-Automatic Gun Holder |
| 2 - Rack Box | 7 - Remote Control |
| 3 - Clamps | 8 - Idler Carriages |
| 4 - Semi-Automatic Gun Holder | 9 - Cable Support Clamps |
| 5 - Bronze Cutting Torch Holder | 10 - Riser Bracket |

FLEX KAT® TRACK AND MOUNTING DEVICES

Gullco Heavy Duty Flexible Track is specifically designed for use with Gullco Flexible KAT® all position travel carriages. Flexible Track is made from specialty tempered spring steel and can be easily mounted to conform with curved surfaces. This Flexible Track can be used in applications involving curved surfaces 60" (1524 mm) diameter and greater. The track is securely mounted on ferrous materials using round or square magnet assemblies and vacuum mount assemblies for non-ferrous materials.



Rare Earth On/Off Track Magnet



Vacuum Track Mounting Device

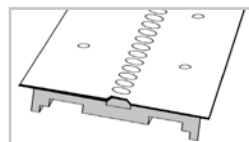
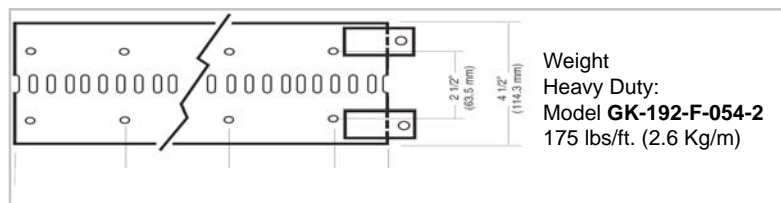

Flexible-Track Stiffener
Extruded aluminum for attachment to Gullco Flexible Track sections for "rigid track" applications. Supplied in 8 ft. sections



KAT® FLEXIBLE-TRACK HEAVY DUTY FLEX-TRACK Model GK-192-F-054-2
Supplied in 8 ft. (2438 mm) lengths. Also available in custom lengths up to 8 ft. (2438 mm) with interlocking ends to facilitate complete circles for diameter 60" (1524 mm), O.D. & I.D. and over. Tracks are easily joined for continuous runs. Other lengths available on request.

KAT, KBM, MOGGY, KATBAK & SAM are registered trademarks of Gullco Enterprises Limited

SPECIFICATIONS ARE SUBJECT TO CHANGE WITHOUT NOTICE. ALL DIMENSIONS ARE NOMINAL

Distributed by:

GULLCO

CANADA - GULLCO INTERNATIONAL LIMITED		
Phone: 905-953-4140	Fax: 905-953-4138	e-mail: sales@gullco.com
U.S.A - GULLCO INTERNATIONAL INC.		
Phone: 440-439-8333	Fax: 440-439-3634	e-mail: ussales@gullco.com
EUROPE - GULLCO INTERNATIONAL (U.K.) LIMITED		
Phone: +44 1257-253579	Fax: +44 1257-254629	e-mail: uksales@gullco.com
AUSTRALIA - GULLCO INTERNATIONAL PTY LIMITED		
Phone: 61 (0)7 3348 5515	Fax: 61 (0)7 3348 5510	e-mail: ausales@gullco.com
INDIA - GULLCO INTERNATIONAL INDIA PVT LIMITED		
Phone: 91-20-6526-0382	Fax: 91-20-2683-6656	e-mail: indsales@gullco.com
CHINA - GULLCO INTERNATIONAL SHANGHAI LIMITED		
Phone: +8621-50460341	Fax: +8621-50463554	e-mail: c.zhang@gullco.com
SINGAPORE - GULLCO INTERNATIONAL LIMITED		
Phone: +65-9385-4468		e-mail: benny.lim@gullco.com
LATIN AMERICA - GULLCO INTERNATIONAL LIMITED		
Phone: 55-11-99485-1336		e-mail: rogerio.macedo@gullco.com
Stuch GmbH & Co. KG Schweisstechnik - GERMANY		
Phone: (02 03) 72 94 95	Fax: (02 03) 72 94 96	e-mail: info@stuch-schweisstechnik.de



AUTOMATIC WELDING CARRIAGE - KAT® AUTO-WELD

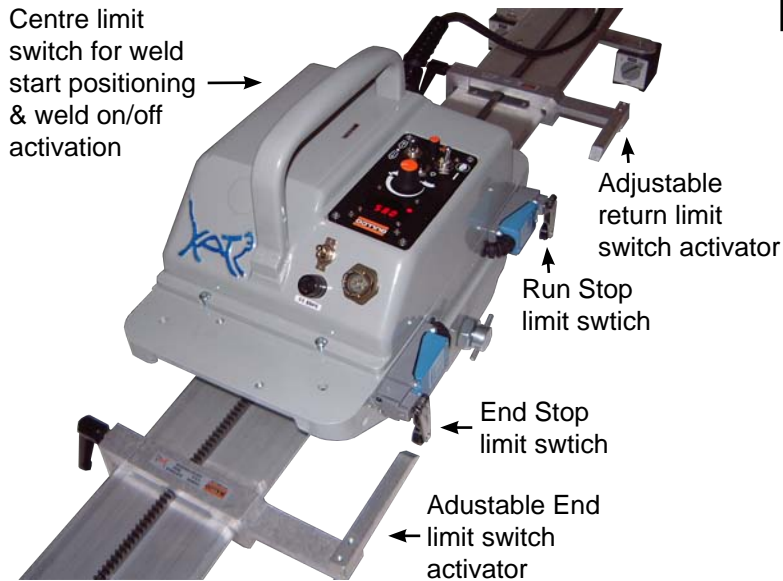

MODEL GK-200-R*-A
For use on KAT® Rigid Track

MODEL GK-200-F*-A
For use on KAT® Rigid Track

* See reverse side for speed and voltage requirements

The KAT® Carriage Auto-Weld enables a wide variety of automated welding cycles that can be repeatedly performed along any plane. The advanced Auto-Weld control monitors, via distance travelled, and responds to limit switches mounted on the KAT® which in turn respond to adjustable activators mounted at appropriate positions on the KAT® Track. Travel direction/speed and length of travel path are synchronized with precise weld start and weld stop settings. By combining different control settings and limit switch activator positions, a wide variety of welding cycles can be repeatedly performed. The KAT® Auto-Weld Combination is ideal for stitch welding and seam welding applications where repeatability and accuracy are desired. The reliability and precision of this automated welding system reduces cost, adds efficiency and improves quality.

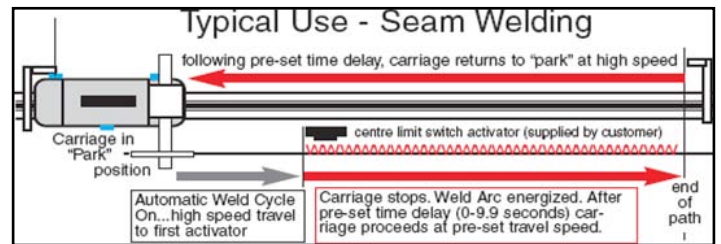
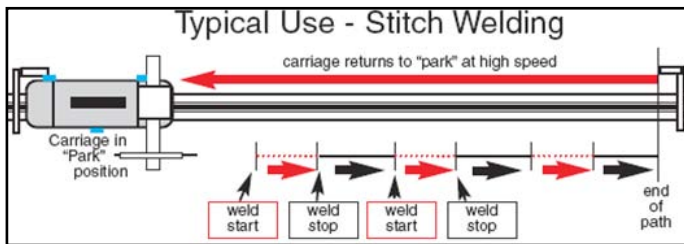

Increase Production and Precision with Weld Automation

PRECISION AND REPEATABLE WELDS CAN BE PRODUCED ALONG ANY PLANE

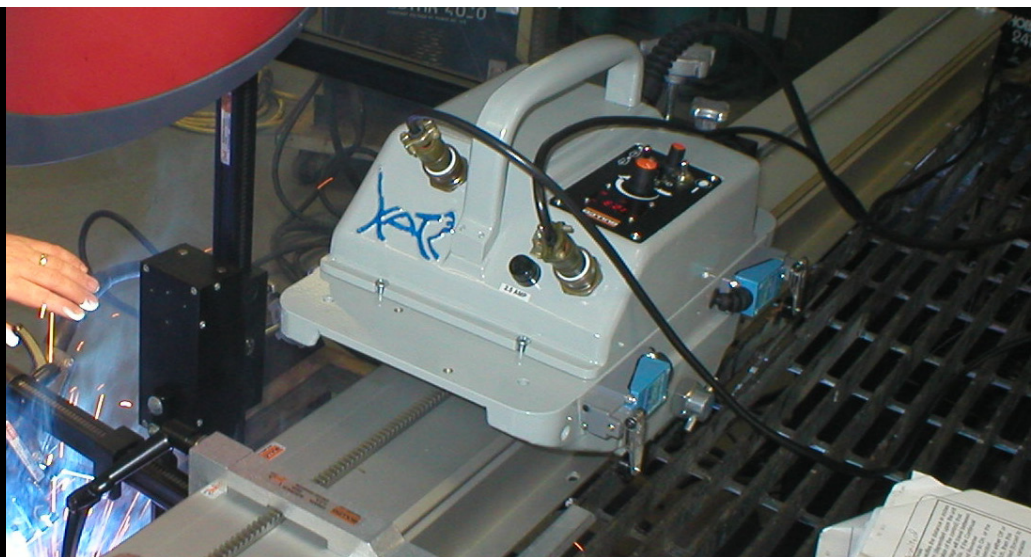

SPECIFICATIONS

KAT® Travel Carriage Auto-Weld Combination comprises:

Gullco Auto-Weld KAT® Travel Carriage with heavy duty self-aligning wheel assemblies and closed loop tack feedback for accurate speed control when running in any plane, regardless of load. Maximum 100 lbs. (45 kgs). Carriage is controlled by the Gullco low voltage 24 volt GSP microprocessor pulsed width modulation motor control, interfacing with the forward/stop/reverse switch and infinitely variable 4-turn speed potentiometer. LED display in IPM or cm/min and with a ten position rotary switch to adjust various functions. Operates on 42, 115 or 230 volts, single phase, 50/60 Hz A.C. power supply. Please specify voltage/speed when ordering. (see below)

Limit Switches - 3 limit switches are mounted on the outside of the carriage. One each for forward, reverse and centre limit for weld start positioning and weld on/off activation.

Adjustable Park and End Limit Switch Activators - for mounting on Gullco KAT® Rigid or Flex Track. Centre limit switch activator(s) to be supplied by the customer.

Optional

Remote Pendant Control Kit - Uses GSP control removed from KAT® Carriage...enabling remote operator control of the Auto-Weld unit. See below for details

NOTE: Gullco also has Kat Carriage models available with controls for Oscillation visit www.gullco.com for more information.

AUTO-WELD CONTROL SYSTEM

Provides settings to establish:

- Operating position
- Travel start delay after arc start signal, adjustable 0 - 9.9 seconds.
- Crater fill delay, allowing the wire feed signal to stay active after carriage stop, adjustable 0- 9.9 seconds.
- Post weld delay, sets a delay adjustable 0 - 9.9 seconds after each crater fill delay for burnback or postflow to occur.
- Weld direction- forward, reverse, or "forward & reverse"
- Center limit switch use, to enable rapid travel to weld start point using center limit switch.*
- Stitch weld electronically programmed using carriage travel distance, adjustable 0.1 - 99.9 in. or cm.
- Carriage travel distance, adjustable 0.1 - 99.9 in. or cm.
- Automatic carriage return to home. Limit switch activated.
- Continual forward and reverse of carriage using limit activators.

*Note: Centre Limit Switch Activator to be supplied by customer

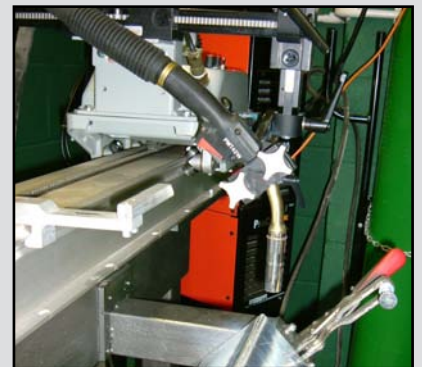

RIGID KAT® AUTO-WELD

MODEL	SPEED RANGE
L	0.5 to 16.4 IPM (1.2 to 41.6 cm/min)
M	1 to 32.7 IPM (2.5 to 83.1 cm/min)
H	2.7 to 88.4 IPM (6.7 to 224 cm/min)

Select a speed range and voltage to determine your Rigid KAT® Auto-Weld Model Number.

VOLTAGES	
MODEL	INPUT SUPPLY
A	42 VAC
B	115 VAC
C	230 VAC

REMOTE PENDANT CONTROL KIT

...for use with Rigid/Flex KAT® Auto-Weld systems. - Comprising Remote Pendant (no control) attached to 8 ft (843.84 cm) control cable one end and KAT® control blanking plate other end with internal connectors at each end. This remote pendant uses the GSP control removed from the KAT® Carriage. This kit can be easily field installed (or factory installed at no charge)

FLEX KAT® AUTO-WELD

MODEL	SPEED RANGE
L	0.8 to 25.8 IPM (2 to 65.4 cm/min)
M	1.5 to 51.5 IPM (3.9 to 131 cm/min)
H	4.2 to 139.1 IPM (10.6 to 353 cm/min)

Select a speed range and voltage to determine your Flex KAT® Auto-Weld Model Number.

VOLTAGES	
MODEL	INPUT SUPPLY
A	42 VAC
B	115 VAC
C	230 VAC

KAT, KBM, MOGGY, KATBAK & SAM are registered trademarks of Gullco Enterprises Limited

Distributed by:

SPECIFICATIONS ARE SUBJECT TO CHANGE WITHOUT NOTICE. ALL DIMENSIONS ARE NOMINAL

GULLCO

CANADA - GULLCO INTERNATIONAL LIMITED		
Phone: 905-953-4140	Fax: 905-953-4138	e-mail: sales@gullco.com
U.S.A - GULLCO INTERNATIONAL INC.		
Phone: 440-439-8333	Fax: 440-439-3634	e-mail: ussales@gullco.com
EUROPE - GULLCO INTERNATIONAL (U.K.) LIMITED		
Phone: +44 1257-253579	Fax: +44 1257-254629	e-mail: uksales@gullco.com
AUSTRALIA - GULLCO INTERNATIONAL PTY LIMITED		
Phone: 61 (0)7 3348 5515	Fax: 61 (0)7 3348 5510	e-mail: ausales@gullco.com
INDIA - GULLCO INTERNATIONAL INDIA PVT LIMITED		
Phone: 91-20-6526-0382	Fax: 91-20-2683-6656	e-mail: indsales@gullco.com
CHINA - GULLCO INTERNATIONAL SHANGHAI LIMITED		
Phone: +8621-50460341	Fax: +8621-50463554	e-mail: c.zhang@gullco.com
SINGAPORE - GULLCO INTERNATIONAL LIMITED		
Phone: +65-9385-4468		e-mail: benny.lim@gullco.com
LATIN AMERICA - GULLCO INTERNATIONAL LIMITED		
Phone: 55-11-99485-1336		e-mail: rogerio.macedo@gullco.com
Stuch GmbH & Co. KG Schweisstechnik - GERMANY		
Phone: (02 03) 72 94 95	Fax: (02 03) 72 94 96	e-mail: info@stuch-schweisstechnik.de



Above: One of the 1.9 m rings during manufacture with the KAT Travel Carriage fitted on the formed KAT track ring. The ring is suspended from the steel bands via swivel mechanisms.

Saipem Finds Innovative Solutions With Gullco Kat® Rings

Several years ago Saipem was faced with the need to cut large diameter pipe that was used in “driven pile” applications. The difficulty was that the oxy-fuel cutting had to be parallel to the horizon while the piles weren’t always truly vertical. Saipem consequently contacted Gullco International [UK] Limited through one of their distributors for assistance. Gullco devised a solution using their world famous “KAT”® Travel carriage System. The “KAT”® is used to automate a wide variety of cutting and

welding applications. Welding guns or, in this case, cutting torches are mounted on the carriage which travels at precisely controlled speeds on special “KAT”® track along any plane. The Saipem application required several innovative modifications in order to achieve the specified horizontal cut. The Gullco solution was comprised of “KAT”® track formed into rings which enabled the “KAT”® carriage to travel around the outside diameter of the pipe. Steel bands used to support the track rings were produced. They were



Above: Due to the elliptical path that the Kat takes around the pipe a spring-loaded float is required to maintain the torch height to work. The completed unit is shown here being tested. Note how the track ring is mounted to the steel band.

PRODUCT APPLICATION FILE

Saipem Uses Kat® Rings for Oxy-Fuel Cutting

bolted to the pipe and the “rings” were suspended from the bands and positioned using an adjustable swivel mechanism and clamping assembly. This allowed the “KAT”® track ring to swivel, enabling a cut at an angle other than 90° to the pipe’s centre line.



Above: close-up of clamping assembly and right: swivel mechanism. A section of the track ring is visible in the bottom left of the picture.



The result; accurate, cost effective, mechanized cutting solution for a difficult application. Gullco has recently supplied three 3 meter systems of the same design.



Above: The pipes may also need to be bevelled, as shown, a swivel nozzle makes this easier.

KAT, MOGGY, KATBAK & SAM are registered trademarks of Gullco Enterprises Limited

SPECIFICATIONS ARE SUBJECT TO CHANGE WITHOUT NOTICE

Distributed by:

GULLCO

CANADA - GULLCO INTERNATIONAL LIMITED Phone: 905-953-4140 Fax: 905-953-4138 e-mail: sales@gullco.com
U.S.A - GULLCO INTERNATIONAL INC. Phone: 440-439-8333 Fax: 440-439-3634 e-mail: ussales@gullco.com
EUROPE - GULLCO INTERNATIONAL (U.K.) LIMITED Phone: +44 1257-253579 Fax: +44 1257-254629 e-mail: uksales@gullco.com
AUSTRALIA - GULLCO INTERNATIONAL PTY LIMITED Phone: 61 (0)7 3348 5515 Fax: 61 (0)7 3348 5510 e-mail: ausales@gullco.com
INDIA - GULLCO INTERNATIONAL INDIA PVT LIMITED Phone: 91-20-6526-0382 Fax: 91-20-2683-6656 e-mail: indsales@gullco.com
CHINA - GULLCO INTERNATIONAL SHANGHAI LIMITED Phone: +8621-50460341 Fax: +8621-50463554 e-mail: c.zhang@gullco.com
SINGAPORE - GULLCO INTERNATIONAL LIMITED Phone: +65-9385-4468 e-mail: benny.lim@gullco.com
LATIN AMERICA - GULLCO INTERNATIONAL LIMITED Phone: 55-11-99485-1336 e-mail: rogerio.macedo@gullco.com
Stuch GmbH & Co. KG Schweisstechnik - GERMANY Phone: (02 03) 72 94 95 Fax: (02 03) 72 94 96 e-mail: info@stuch-schweisstechnik.de

WWW.GULLCO.COM

Gulco Develops Twin-Arc Seam Welder System For Box Section Crane Parts

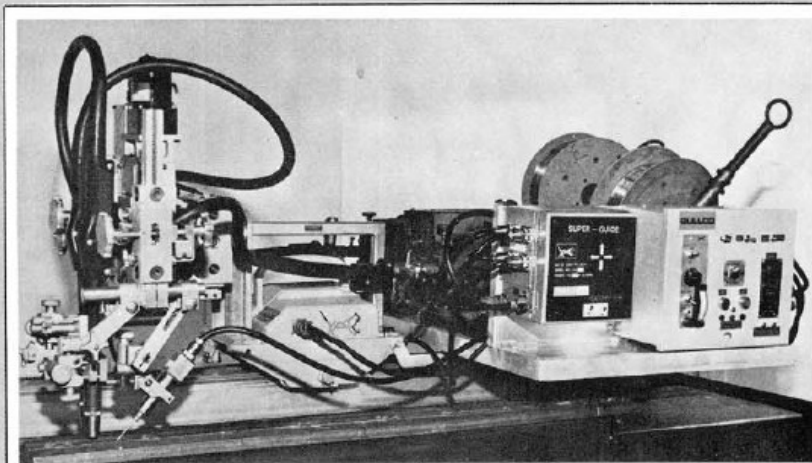

Gulco's variable speed travel carriage and electronic seam tracker, modified to position two torches in micro-adjustable gun holders, was used for 20-foot long seam welds on all four corners of new box section crane components.

Using various welding components of the MIG welding process in a fully automatic mode, a tool was designed to weld two 20-foot long seam welds at the same time.

WHEN Pitman Manufacturing Co. Inc. of Markham, Ontario, Canada, began its industrial engineering and tooling program for a new series of hydraulic, truck-mounted cranes, it became clear that a new welding process would be required.

Pitman has extensive experience in long automatic seam welding, using the Submerged Arc Process, but the new high tech product designs from their Engineering Department called for 20-foot long seam welds on all four corners of new, box section crane components. The new joint designs were perceived as not being applicable to the company's existing submerged arc welding process. A decision was made to apply the MIG Process in a fully automatic mode, controlling two torches and welding two joints at the same time.

Experiments were initiated at Pitman to determine the exact welding parameters required to successfully complete each joint. Gulco International Ltd. was contacted to examine the type of equipment required to automate the process.

The equipment chosen was Gulco's "KAT" variable speed Travel Carriage and Gulco's electronic Seam Tracker modified to position two 400 amp. water-cooled, Bernard torches in micro-adjustable gun holders.

Tests proved out the concept that two seams could be put down at the same time, using a single automatic seam tracker provided that the indi-

vidual guns could be accurately set up for each different joint design and size.

The Gulco micro-adjustable gun holders enable the machine operator to repeat proven set-ups within 0.010 tolerance providing fast change-over time from one set of section design to the next.

The automation aspect of this process was then addressed by Gulco with the design and installation of a single operator control station providing control of all travel carriage, seam tracker and torch ignition functions. The control station is integrated with the travel carriage which also carries the two identical "Hobart 2000" series wire feeders and two spools of ER480S-6 wire. The welding parameters of wire size, wire feed speed, feeders and at the 2 "Hobart" MEGA-MIA RVS 650 power sources.

The operator sets the carriage travel speed to the required DATA setting for the joints and orients the torches into the specified angular approach setting. . . then zero adjusts the automatic seam follower for pre-determined torch stick-out setting.

The welding operation is then performed automatically with the operator now controlling travel carriage stop-start and torch stop-start at the front mounted travelling control station. The installation was completed with the incorporation of a Bernard 3500SS Water Cooler, to cool the two straight shank mounted Bernard 400 AMP water cooled Torches.

Pitman's need for high quality seam welding for two joints at a time and the cooperative efforts of the company's welding engineers and supervisors with Gulco's application personnel resulted in the development of a highly successful Low Cost automatic, twin-arc seam welder system. . . conceived and assembled out of available, high quality and proven welding components and automated to provide weld control from the beginning to end of seams.

By removing the variables of manual controls and automating the welding process, using pre-determined valves and settings, Pitman produces precise filler profiles at high travel speeds with the two torches counteracting the tendency of each torch to induce distortion in the box section being produced.

Pitman cites this system as a striking example of how highly effective automation can be accomplished using readily available and serviceable components in unique arrangements without the costs of custom-designed, "one off" specialty equipment.

reprint from:

Canadian Welder & Fabricator



WELDING AND CUTTING CARRIAGE ACCESSORIES - KAT®

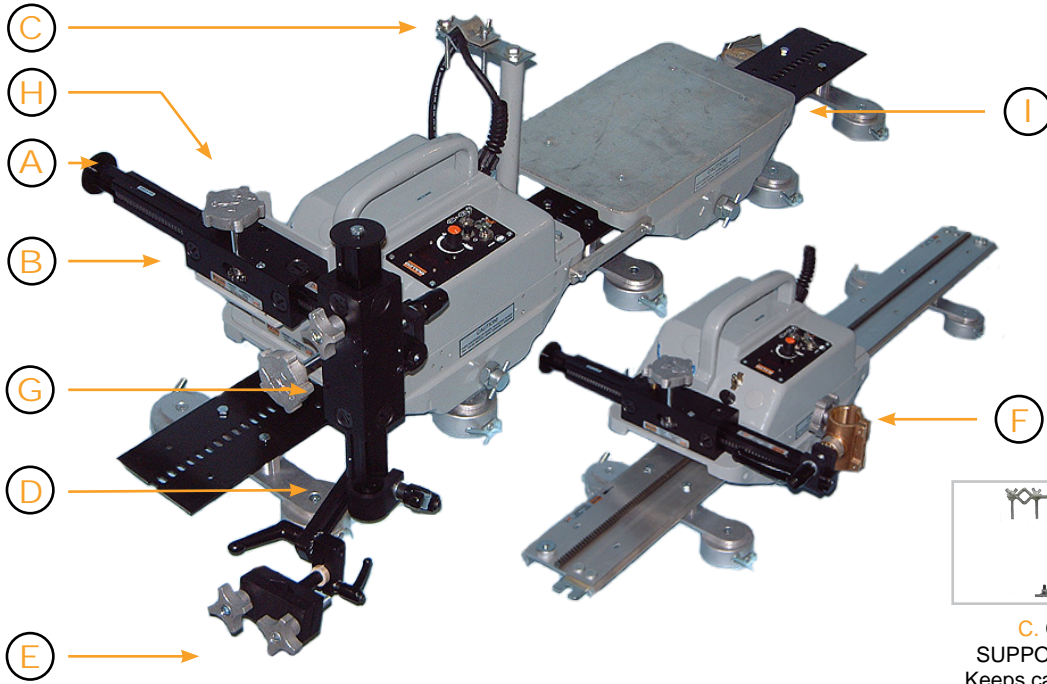

A. RACK ARM
Square with one end turned. Heavy duty & Extra heavy duty



B. RACK BOX
Available with standard or micro adjustment. Cross head & Arm Mount rack boxes also available

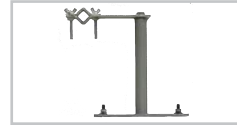

C. CABLE SUPPORT CLAMP
Keeps cables clear of work area



D. CLAMPS
Available as swivel or square.



E. SEMI-AUTOMATIC GUN HOLDERS
Suitable for most semi-automatic welding guns



F. BRONZE CUTTING TORCH HOLDERS
Accepts standard 1 3/8" (35 mm) cutting torch



G. 4 MOTION SEMI-AUTO GUN HOLDER
Mounts on the KAT® horizontal rack arm to provide 5" (127 mm) of vertical adjustment 360° torch rotation & two directional angle tilt



H. RISER BRACKET
To mount rack box higher than carriage when required

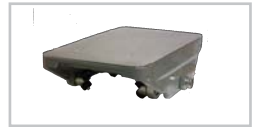

I. IDLER CARRIAGE
For conveying auxilliary welding and cutting equipment



RACK BOXES

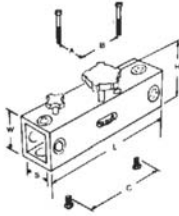

		H	W	L	S	A	B	C
HEAVY DUTY GK-171-650 GK-171-655*	In.	4.25	2.0625	6	1.125	1.625	2.625	-
	mm.	10.8	52.39	152.4	28.57	41.27	66.67	-
EXTRA HEAVY DUTY GK-190-650 GK-190-655*	In.	4.5	2.5	10	1.5	2	3.3	6
	mm.	114.3	63.5	254	38.1	50.8	83.82	152.4

***WITH MICRO FINE ADJUSTMENT GEAR BOX**

RACK BOXES FOR ARM MOUNTING

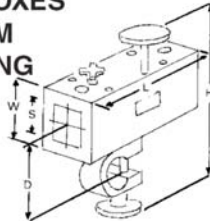

		H	W	L	S	D
HEAVY DUTY GK-171-685 GK-171-690*	In.	7	2.0625	6	1.125	1.75
	mm.	177.8	52.39	152.4	28.57	44.45
EXTRA HEAVY DUTY GK-190-685 GK-190-690*	In.	7.5	2.5	10	1.5	2.25
	mm.	190.5	63.5	254	38.1	57.15

***WITH MICRO FINE ADJUSTMENT GEAR BOX**

RACK ARMS



HEAVY DUTY RACK ARMS

1 1/8" (29mm) square rack arm and rack with one end turned to 1 1/8" (29mm) diameter

GK-171-047-1 12" (305mm) long

GK-171-047-2 18" (457mm) long

GK-171-047-3 24" (610mm) long

GK-171-047-4 36" (914mm) long

other lengths available on request

EXTRA HEAVY DUTY RACK ARMS

1 1/2" (38mm) square rack arm and rack with one end turned to 1 1/8" (29mm) diameter

GK-190-047-2 18" (457mm) long

GK-190-047-3 24" (610mm) long

GK-190-047-4 36" (914mm) long

other lengths available on request

CLAMPS

Swivel Clamps

for mounting torch holders, rack boxes and other KAT® accessories

		Dia.	W	D	A
HEAVY DUTY GK-166-183	In.	1.125	1.625	1.25	.775
	mm.	28.57	41.27	31.75	19.68

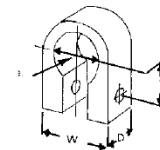

Square Clamps

for mounting welding guns, cutting torches and other KAT® accessories

		Dia.	W	D	A
HEAVY DUTY GK-166-236	In.	1.125	1.625	1.125	1.0625
	mm.	28.57	41.27	28.57	27
EXTRA HEAVY DUTY GK-190-236	In.	1.5	2.125	1.25	1.437
	mm.	38	54	31.75	36.5

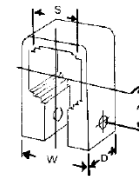

RACK BOX RISER BRACKET

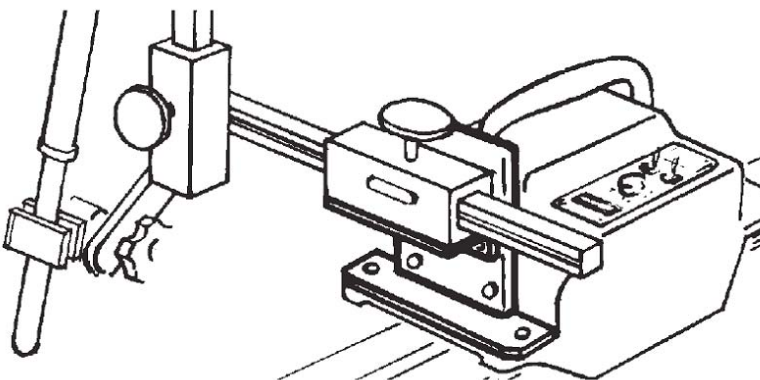

MODEL GK-190-066

For applications that require a mounting surface higher than the level provided with the rack box mounted directly on the front of the KAT® Carriage. Height can be increased by 2, 4 or 6" (51, 102 or 152 mm).

TORCH HOLDERS AND ASSEMBLIES

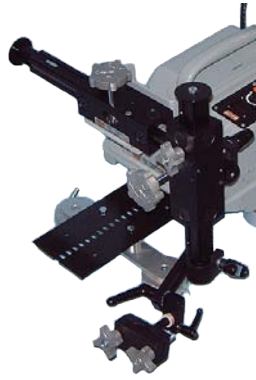

SEMI-AUTOMATIC 4 MOTION WELDING GUN HOLDER

MODEL GK-165-074-2

(complete unit)... For mounting on the KAT® horizontal rack arm to provide 5" (127 mm) of vertical adjustment, 360° torch rotation and two directional tilt. Supplied complete with standard 1 1/8" (29 mm) I.D. swivel clamp* and insulated linkage for the gun holder which is suitable for most semi-automatic welding guns. Gun holder jaws are adjustable from 5/8" (16 mm) to 1 1/2" (38 mm) *Note: can be supplied with 1 1/8" (29 mm) or 1 1/2" (38 mm) square clamp.

SEMI-AUTOMATIC GUN HOLDER



MODEL GK-165-145 (complete unit)... Complete with standard 1 1/8" (29 mm) I.D. swivel clamp* and insulated linkage for the gun holder which is suitable for most semi-automatic welding guns. Gun holder jaws are adjustable from 5/8" (16 mm) to 1 1/2" (38 mm) *Note: can be supplied with 1 1/8" (29 mm) or 1 1/2" (38 mm) square clamp

IDLER CARRIAGES

GK-171-154

Provides an 8 3/4" x 14 7/8" platform on which a variety of welding/cutting equipment can be mounted and towed



individually or in tandem along straight or formed sections of KAT® Track by the Gullco KAT® Travel Carriage. Self aligning retractable wheels enable easy mounting at any point along the track. Load capacity is 100lbs.

REMOTE CONTROL PENDANT

Supplied with 10 ft. (304.8 cm) cable providing control of numerous KAT® functions.



STANDARD CUTTING TORCH HOLDER

GK-165-068B

Accepts standard 1 3/8" (35 mm) cutting torches with 32 pitch rack. Supplied with calibrated angle of tilt scale and 1 1/8" (29 mm) or 1 1/2" (38 mm) square clamp.



CABLE SUPPORT CLAMP

GK-181-027

Swivel clamp assembly is readily mounted on the front or back of the KAT® Travel Carriage to keep cables clear of the work area. Clamp can be adjusted to provide approximately 1 3/4" diameter holding opening



SEAM TRACKER SYSTEM



...high precision tracking system that maintain the torch in optimum operating position regardless of variations in the weld seam...providing improved quality and efficiency in a wide variety of welding operations.

GULLCO

**WORLD LEADERS IN THE DESIGN,
MANUFACTURE & DISTRIBUTION OF AUTOMATED
WELDING SYSTEMS AND ACCESSORIES
CUT COSTS, IMPROVE QUALITY, AND INCREASE EFFICIENCY WITH THESE PROVEN
GULLCO PRODUCTS**



KAT® SYSTEMS

- Oscillators
- Torch indexers
- Flex & Rigid KAT® Programmable Travel Carriages
- Seam Trackers
- Bridge Units
- Circle Cutting System

MOGGY®

- Trackless Fillet & Butt Welding, Stitch Welding control
- Radial Oscillation Control
- 6" V-groove Track Available

WELD PREP

- Bevellers
- Positioners
- Grippers
- Kamel Pipe
- Turning Rolls

OVENS

- Flux Rebake
- Flux Holding
- Flux Hoppers
- Electrode Stabilizing

CERAMIC BACKING

- KATBAK® Ceramic Weld Backing
- Impart Uniform X-Ray Quality Back Beads
- Eliminate Costly Grinding & Re-welds
- Knuckle Joints for Use On Flat or Curved Surfaces

CONTACT GULLCO OR YOUR GULLCO DISTRIBUTOR TODAY FOR INFORMATION ON ANY OF THESE PRODUCTS

KAT, KBM, MOGGY, KATBAK & SAM are registered trademarks of Gullco Enterprises Limited

SPECIFICATIONS ARE SUBJECT TO CHANGE WITHOUT NOTICE, . ALL DIMENSIONS ARE NOMINAL

Distributed by:

GULLCO		
CANADA - GULLCO INTERNATIONAL LIMITED		
Phone: 905-953-4140	Fax: 905-953-4138	e-mail: sales@gullco.com
U.S.A - GULLCO INTERNATIONAL INC.		
Phone: 440-439-8333	Fax: 440-439-3634	e-mail: ussales@gullco.com
EUROPE - GULLCO INTERNATIONAL (U.K.) LIMITED		
Phone: +44 1257-253579	Fax: +44 1257-254629	e-mail: uksales@gullco.com
AUSTRALIA - GULLCO INTERNATIONAL PTY LIMITED		
Phone: 61 (0)7 3348 5515	Fax: 61 (0)7 3348 5510	e-mail: ausales@gullco.com
INDIA - GULLCO INTERNATIONAL INDIA PVT LIMITED		
Phone: 91-20-6526-0382	Fax: 91-20-2683-6656	e-mail: indsales@gullco.com
CHINA - GULLCO INTERNATIONAL SHANGHAI LIMITED		
Phone: +8621-50460341	Fax: +8621-50463554	e-mail: c.zhang@gullco.com
SINGAPORE - GULLCO INTERNATIONAL LIMITED		
Phone: +65-9385-4468		e-mail: benny.lim@gullco.com
LATIN AMERICA - GULLCO INTERNATIONAL LIMITED		
Phone: 55-11-99485-1336		e-mail: rogerio.macedo@gullco.com
Stuch GmbH & Co. KG Schweisstechnik - GERMANY		
Phone: (02 03) 72 94 95	Fax: (02 03) 72 94 96	e-mail: info@stuch-schweisstechnik.de

ALL POSITION CUTTING CARRIAGE - KAT®II



This automated welding system* incorporates everything required to automate your cutting and welding operations quickly, easily and economically. It is comprised of the KAT® II Travel Carriage, rigid 8 ft. (2438 mm) straight track and torch or gun holder assembly. The carriage travels in a forward or reverse direction (vertical or horizontal) on its track, moving the torch or welding gun along the pre-set path at precisely controlled speeds. The accuracy, uniformity and quality of the cut or weld is improved with this process. Productivity is increased, and costs are reduced. It is important to note that the KAT® II carriage is not designed to travel on radius roll formed track. (For this see the KAT® Carriage)

*The carriage and torch holding assemblies are sold separately.

EASILY CONVERT YOUR KAT® II INTO AN EXCELLENT CIRCLE CUTTING MACHINE

This Gullco accessory, comprised of an undercarriage, radius arm and centering pin, eliminates the need for track. The travel carriage is readily fitted on the top of the undercarriage. Its drive system engages the undercarriage gears moving the assembly in a forward or reverse direction at desired cutting speeds along a perfectly circular path. A slide lock on the radius arm allows fast, easy adjustment of the circular diameter.



Inexpensive Automation Solution for Cutting and Welding Operations

ALL POSITION CUTTING AND WELDING CARRIAGE

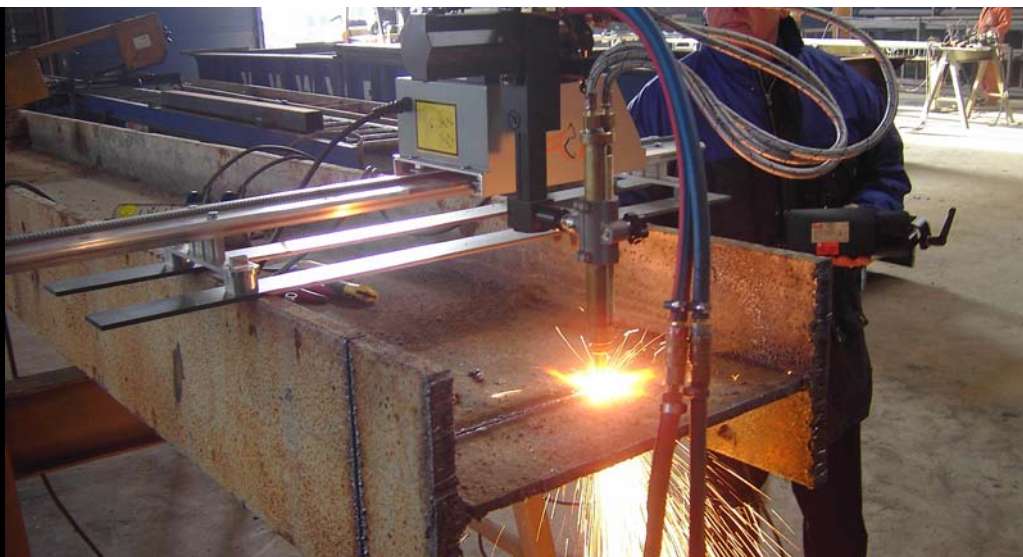

SPECIFICATIONS

KAT® II AUTOMATED CUTTING AND WELDING SYSTEM

The Gullco KAT® II Travel Carriage is combined with an appropriate series of accessories to provide either the Torch Cutting Package or Welding Package. The following briefly describes the KAT® II carriage:

KAT® II Carriage- Model GK-189-045

A light duty, all position variable speed travel carriage with electronic drive, dynamic braking and speed potentiometer providing infinite speed selection within the range of 2-45 IPM (5-114 cm/min.). It is equipped with Forward/Reverse switch, Run/Stop switch, slow blow fuse, and "power on" pilot light. The carriage is designed to run only on rigid, straight KAT® track. The carriage has a vertical load capacity of 50 lbs. (23 kg.)

Safety is assured by the use of Gullco's low voltage, (24 volt D.C) highly advanced control and power supply system that is available in three line voltage inputs: 42, 110, and 230 volt A.C single phase, 50/60 Hz. Specify line voltage when ordering.

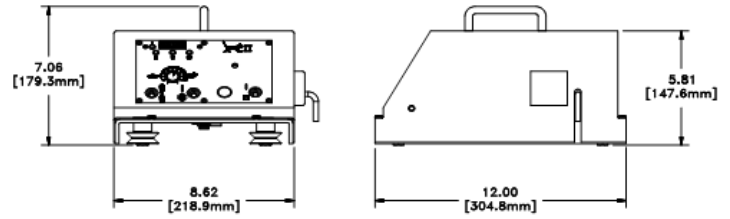

Approx. Weight: 17 lbs (7.8 kg)

CUTTING OR WELDING TORCH RACK ACCESSORY

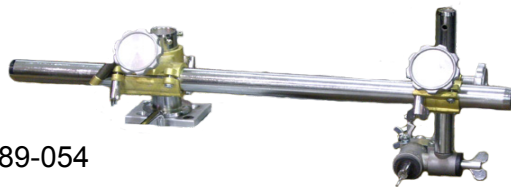

GK-189-054

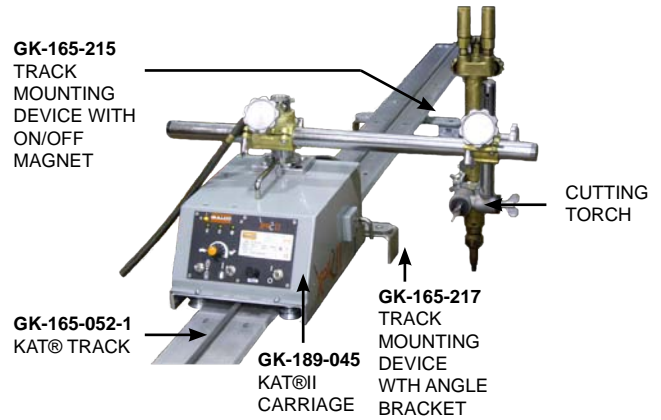

WELDING OR CUTTING TORCH RACK

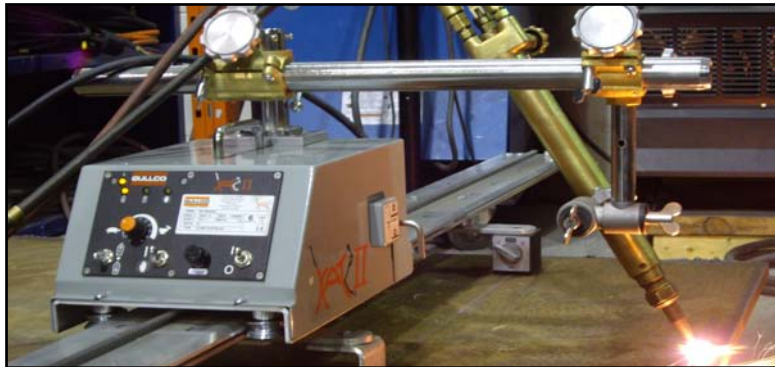
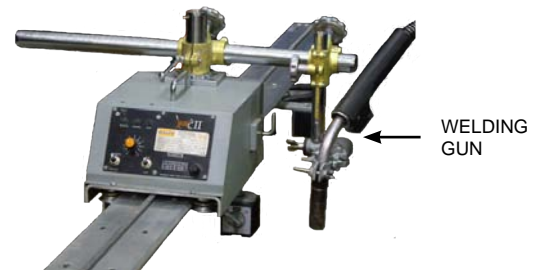

MODEL GK-184-200 CIRCLE CUTTING ACCESSORY

Includes Items NOT SHOWN:

Undercarriage: equipped with gear assembly that is engaged and driven by carriage gear system. This also includes a clutch that allows free-wheeling during set-up. Radius arm- 36" long with slide/lock for diameter size adjustment. Magnet/Holder for centering pin. (not shown in cover photo).

KAT, KBM, MOGGY, KATBAK & SAM are registered trademarks of Gullco Enterprises Limited

Distributed by:

SPECIFICATIONS ARE SUBJECT TO CHANGE WITHOUT NOTICE. ALL DIMENSIONS ARE NOMINAL

GULLCO

CANADA - GULLCO INTERNATIONAL LIMITED

Phone: 905-953-4140 Fax: 905-953-4138 e-mail: sales@gullco.com

U.S.A - GULLCO INTERNATIONAL INC.

Phone: 440-439-8333 Fax: 440-439-3634 e-mail: ussales@gullco.com

EUROPE - GULLCO INTERNATIONAL (U.K.) LIMITED

Phone: +44 1257-253579 Fax: +44 1257-254629 e-mail: uksales@gullco.com

AUSTRALIA - GULLCO INTERNATIONAL PTY LIMITED

Phone: 61 (0)7 3348 5515 Fax: 61 (0)7 3348 5510 e-mail: ausales@gullco.com

INDIA - GULLCO INTERNATIONAL INDIA PVT LIMITED

Phone: 91-20-6526-0382 Fax: 91-20-2683-6656 e-mail: indsales@gullco.com

CHINA - GULLCO INTERNATIONAL SHANGHAI LIMITED

Phone: +8621-50460341 Fax: +8621-50463554 e-mail: c.zhang@gullco.com

SINGAPORE - GULLCO INTERNATIONAL LIMITED

Phone: +65-9385-4468 e-mail: benny.lim@gullco.com

LATIN AMERICA - GULLCO INTERNATIONAL LIMITED

Phone: 55-11-99485-1336 e-mail: rogerio.macedo@gullco.com

Stuch GmbH & Co. KG Schweisstechnik - GERMANY

Phone: (02 03) 72 94 95 Fax: (02 03) 72 94 96 e-mail: info@stuch-schweisstechnik.de

WWW.GULLCO.COM

HYDRAULIC KAT® AUTOMATION CARRIAGE



The Gullco Hydraulic KAT® is a heavy duty, all position automation carriage. It is hydraulically powered and self propelled in both the forward and reverse direction at precisely controlled speeds. The Hydraulic KAT® runs along a special track using self aligning wheels to grip the top and bottom of the track enabling travel along any plane.

The bogey wheel assembly keeps the carriage snug to the track, while allowing it to be easily mounted and removed from the track at any point. The positive drive of the KAT® is obtained from either a pinion that engages with the rack of the rigid track, or a ball drive gear that engages with slots in the flexible track. These are driven by a low speed, high torque hydraulic motor and gear-head power unit assembly.

As the Hydraulic KAT® automation carriage is most often used in waterjet cutting applications, the KAT® lower housing and wheel housing assembly are hard anodized and the mating surfaces are dry lube filmed for maximum internal moisture resistance. All gears and metallic parts are plated for added durability and all carriages are equipped with a lower housing gear cover.

No Electrical Components - Ideal for Waterjet Cutting

ALL POSITION CUTTING AND WELDING CARRIAGE

The Gullco logo, featuring the word 'GULLCO' in bold black letters on a white background, with a yellow bar above and below.

WELDING AND CUTTING



SPECIFICATIONS

Carriage Weight: 23 lbs (10.4 kg)

Vertical Load Capacity: 150 lbs (68 kg)

Hydraulic Supply: 1,000 psi (69 bars) recommended, with a flow of 4 gpm (18.2 lpm)

Certification: C.E. Certification

MODEL	SPEED RANGE	TRACK USED
GK-190-H-018	0 - 4.9 in/min (0 - 12.4 cm/min)*	Rigid
GK-190-H-036	0.5 - 9.8 in/min (1.3 - 24.9 cm/min)*	Rigid
GK-190-H-090	1 - 26.5 in/min (0 - 19.1 cm/min)*	Rigid
GK-190-H-017	0 - 7.5 in/min (2.5 - 38.1 cm/min)*	Flexible
GK-190-H-035	1 - 15 in/min (2.5 - 38.1 cm/min)*	Flexible
GK-190-H-089	2 - 40.5 in/min (5.1 - 102.9 cm/min)*	Flexible

* The speed range given above is based on an oil pressure of 1,000 psi (69 Bars) with a flow of 4 gallons per minute (18.2 litres per minute). This is intended only as a guide and greater detail is provided in the operation manual.

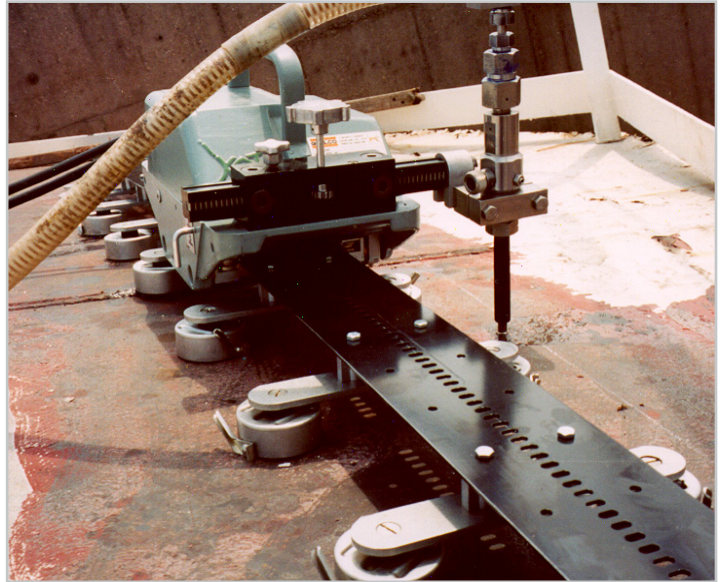

Displacement cu. in./rev. (cu. cm./rev.)		.50 (8.2)
Speed (RPM)	Per GPM (3.8 LMP) Theo.	471
	@ Continuous Flow	2000
	@ Peak Flow	2500
Flow GPM (LPM)	Continuous	4 (16)
	Peak	5 (20)
Torque lb. in. (Nm)	Per 100 Δ P (Theo.)	7.8 (0.88)
	Continuous	57 (6.44)
	Peak	117 (13.2)
Pressure PSI (Bar)	Continuous Δ P	1000 (69)
	Peak Δ P	2000 (138)
Back Pressure PSI (Bar)	w/o external case drain	360 (24.8) cont. 1100 (76) Peak
	w/ external case drain	2000 (138) cont. 2500 (172) Peak
Weight lbs (kg)		3.5 (1.59)

ACCESSORIES

GK-181-027 - Cable Support Assembly - A raised cable/hose clamp that attaches to the KAT® carriage, with an adjustable swivel clamp, used to reduce cable/hose drag and interference.

GK-166-153 - High Speed Gear Assembly - An external gear assembly is available which can easily be fitted to any of the rigid track KAT® carriages to increase the available speed range by approximately 266.5%. This is not available for Flex KAT® carriages.

GK-166-169 - Low Speed Gear Assembly - A similar external gear assembly to that above, for lowering the speed range by approximately 42.6% is also available. This is not available for Flex KAT® carriages.

Other Accessories - The KAT® carriage is designed to incorporate rack boxes and rack box riser brackets, as well as links for towing idler carriages. See www.gullco.com for more details on these and other accessories.

KAT, KBM, MOGGY, KATBAK & SAM are registered trademarks of Gullco Enterprises Limited

Distributed by:

Δ PSI = True pressure difference between inlet and outlet ports

Maximum pressure at the motor inlet port of 2500 PSI (172 Bar) without regard to Δ PSI and/or back pressure ratings or combination thereof.

Continuous rating = Motor may be run continuously at these ratings

Peak operation 10% of every minute

Recommended Viscosity = 100 SUS (20 cSt) at operating temperature

Recommended Maximum System Operating Temperature = 180° F (82° C)

Recommended Filtration = 10 Micrometer

SPECIFICATIONS ARE SUBJECT TO CHANGE WITHOUT NOTICE. ALL DIMENSIONS ARE NOMINAL

GULLCO

CANADA - GULLCO INTERNATIONAL LIMITED
 Phone: 905-953-4140 Fax: 905-953-4138 e-mail: sales@gullco.com

U.S.A - GULLCO INTERNATIONAL INC.
 Phone: 440-439-8333 Fax: 440-439-3634 e-mail: ussales@gullco.com

EUROPE - GULLCO INTERNATIONAL (U.K.) LIMITED
 Phone: +44 1257-253579 Fax: +44 1257-254629 e-mail: uksales@gullco.com

AUSTRALIA - GULLCO INTERNATIONAL PTY LIMITED
 Phone: 61 (0)7 3348 5515 Fax: 61 (0)7 3348 5510 e-mail: ausales@gullco.com

INDIA - GULLCO INTERNATIONAL INDIA PVT LIMITED
 Phone: 91-20-6526-0382 Fax: 91-20-2683-6656 e-mail: indsales@gullco.com

CHINA - GULLCO INTERNATIONAL SHANGHAI LIMITED
 Phone: +8621-50460341 Fax: +8621-50463554 e-mail: c.zhang@gullco.com

SINGAPORE - GULLCO INTERNATIONAL LIMITED
 Phone: +65-9385-4468 e-mail: benny.lim@gullco.com

LATIN AMERICA - GULLCO INTERNATIONAL LIMITED
 Phone: 55-11-99485-1336 e-mail: rogerio.macedo@gullco.com

Stuch GmbH & Co. KG Schweisstechnik - GERMANY
 Phone: (02 03) 72 94 95 Fax: (02 03) 72 94 96 e-mail: info@stuch-schweisstechnik.de

TRACK AND MAGNETS FOR THE KAT® AUTOMATION CARRIAGE



FLEXIBLE KAT®
TRACK



RIGID KAT®
TRACK



DEEP SECTION
TRACK



ON / OFF MAGNET ASSEMBLY



SELF ALIGNING
MAGNET ASSEMBLY



VACUUM TRACK DEVICE



FORMED RING
CLAMP

A track mounting device for any material

DURABLE TRACK AND MOUNTING DEVICES FOR WELDING AND CUTTING AUTOMATION



GULLCO RIGID KAT® TRACKS

KAT® Track is manufactured in "Standard" and "Deep" sections... each designed to suit a specific range of applications. Both are made to the highest quality levels and incorporate the following top performance features:

PRECISION EXTRUDED ALUMINUM TRACK—made from aluminum that is solution heat treated and artificially aged to produce an alloy having excellent mechanical and corrosion resistant properties. The track is light but strong and the standard section can be readily formed to suit the work contour.

SUPPORTING STEEL RACK—is securely fixed to the KAT® track to provide a smooth, positive drive. The long-life rack easily supports the Kat carriage under maximum load when used in a vertical position.

END DESIGN—enables any two lengths of track to mate accurately and, because of symmetry of design, track lengths can be turned end to end. It is even possible to mate standard and deep track sections.

FAST, EASY JOINING—a dovetail and taper screw that provides accurate location between mating track lengths. The track can be joined in the time it takes to tighten two knurled thumb screws.

VERSATILE MOUNTING—Both standard and deep section tracks have fixing holes on 6" (152.4 mm) pitch along their entire length to provide ample means for mounting or securing brackets.

STANDARD SECTION TRACK

For use with the Gullco KAT® Travel Carriage Model GK-200 in most portable applications. Standard track sections are supplied in 48, 96 and 120 inch (1219, 2438 and 3048 mm) lengths complete with rack and interlocking ends. Standard track can be hard anodized and also formed to desired contours by Gullco or the customer. (see below)

MODEL	LENGTH	MODEL	LENGTH
GK-165-052	48" (1219 mm)	GK-165-052-1	96" (2438 mm)
GK-165-054	120" (3048 mm)		

also available up to 20 ft (6096 mm) long-special order

DEEP SECTION TRACK For use with the Gullco KAT® Travel Carriage in applications involving straight permanent runs where greater stiffness is required. Supplied in 60" and 120" (1524 and 3048 mm) lengths complete with interlocking ends. Deep Section Track can also be supplied internally stiffened and hard anodized.

MODEL	LENGTH	MODEL	LENGTH
GK-166-258	60" (1524 mm)	GK-166-260	120" (3048 mm)

also available up to 20 ft (6096 mm) long-special order

FORMING STANDARD KAT® TRACK

The following information is provided as a guide to customers ordering Standard Section track preformed to the desired contour by Gullco, or to be formed in their own shop.

1. "Track Datum" always refers to the track surface to which the rack is fixed.
2. When the rack is on the outside of the curve, the "Track Datum Radius" must be greater than 12" (304.8 mm).
3. When the rack is on the inside of the curve, the "Track Datum Radius" must be greater than 24" (610 mm).
4. Always specify whether rack is on the inside or outside of the curve.
5. Standard formed track lengths are 36" (914 mm) and 84" (2133 mm). This is because the first 6" (152 mm) at either end of a track cannot be formed and is therefore removed after bending.

6. When calculating the "Track Datum Radius", allowance must be made for the method of fixing the track to the work. The minimum allowable work to "Track Datum" distance (to permit free movement of the KAT® carriage) is 1-1/2" (38 mm) and when using the standard magnet assemblies this distance is 2-7/8" (73 mm).

KAT® formed track may be held in position by track mounting devices (i.e. magnets, steel brackets tack welded in position, or vacuum cups), or it may be permanently attached to framework alongside the work piece.

If your formed track is of a very permanent nature, it is often advisable to have a section formed and stiffened with welded aluminum side plates. This gives the stiffness of a deep section track in a formed shape. This method is often used in complete ring sections for cutting or welding large diameter pipes.

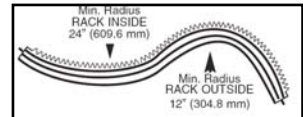

Track Mounting Devices

Shown at right are the Round and Square Magnet devices and steel bracket assemblies used to mount either Gullco Rigid KAT® tracks or Flex-KAT® tracks on ferrous surfaces. Gullco's Vacuum Track Mounting system, described in a separate bulletin, holds KAT® Tracks in position on non-ferrous and ferrous materials.

ON/OFF MAGNET ASSEMBLIES - GK-165-215 feature two powerful magnets each with 150 lbs (45 kg.) of holding power and on/off knob for easy installation.

SELF ALIGNING ON/OFF MAGNET ASSEMBLIES - GK-165-263 feature two powerful magnets each with 150 lbs (45 kg.) of holding power and positive on/off switch. The magnets are mounted in a special self aligning bracket to allow for use on curved surfaces.

STEEL BRACKET ASSEMBLIES - GK-165-217 are used with magnet assemblies to provide track stability. They also must be used for added safety, tack welded to the work surface in vertical and overhead welding applications. The models can be used with each of the magnet assemblies. Standard brackets are mild steel but are available in stainless steel on request.

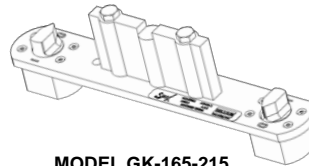

MODEL GK-165-215
Consists of two (2) GK-165-211 magnets with on/off switch. Track datum height 3-1/8" (79.4 mm)

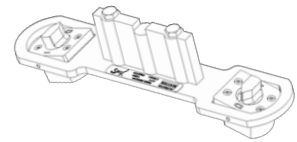

MODEL GK-165-263
Consists of two (2) GK-165-211 magnets with on/off switch in a self aligning support bar assembly. Track datum height 3-1/8" (79.4 mm)

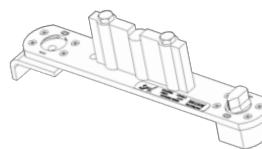

MODEL GK-165-219
Consists of one (1) GK-165-211 magnet with on/off switch, one (1) steel angle bracket. Track datum height 3-1/8" (79.4 mm)

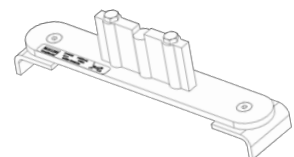

MODEL GK-165-217
Consists of 2 steel angle brackets. Track datum height 3-1/8" (79.4 mm)

GULLCO KAT® FLEXIBLE TRACK

KAT® FLEXIBLE TRACK HEAVY DUTY FLEXIBLE TRACK

Model **GK-192-F-054-2**

Supplied in 8ft. (2438 mm) lengths. Also available in custom lengths up to 8 ft. (2438 mm) with interlocking ends to facilitate complete circles for diameter 60" (1524 mm), O.D.& I.D. and over.

Other lengths available on request.

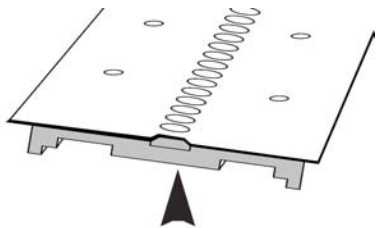

Flexible-Track **STIFFENER** ADAPTS FLEX-TRACK SECTION FOR USE IN RIGID TRACK APPLICATIONS

Provides extra stiffness and reduces the number of magnet or vacuum track mounting devices required.

MODEL **GK-192-F-057**

Extruded aluminum stiffener for attachment to Gullco Flexible-Track sections supplied in 8 ft. (2438 mm) lengths.

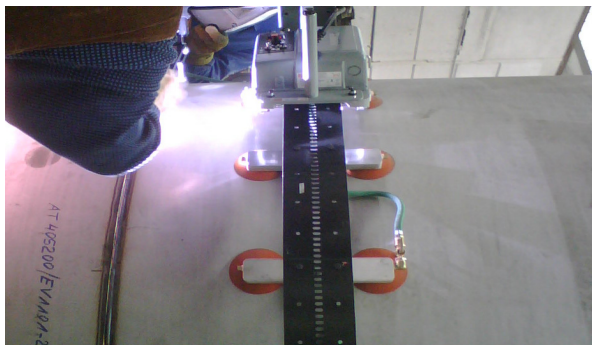

Gullco Heavy Duty "Flexible Track" is specifically designed for use with the Gullco "Flexible KAT® All Position Travel Carriages as shown in application at left. Flexible Track is made from tempered spring steel and can be easily mounted to conform with curved surfaces. This Flexible Track can be used in applications involving curved surfaces 60" (1524 mm) diameter and greater.

QUICK RELEASE FORMED RING MOUNTING ASSEMBLY

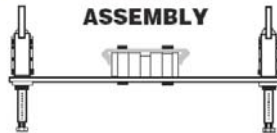

Holds formed "rings" of track in position for pipe welding on non-ferrous and ferrous materials. Heights can be adjusted from 2.8 in. (71.1mm) to 4.95" (125.7mm). Different heights can be achieved using different length 5/16"-18UNC bolts.

KAT VACUUM TRACK MOUNTING SYSTEMS

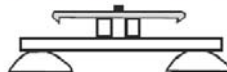

Holds track in position on non-ferrous and ferrous materials.

PERPENDICULAR TRACK MOUNTING BRACKET Model GK-190-046

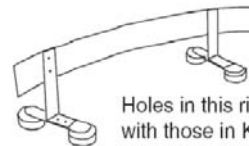

Holes in this rigid steel bracket align with those in Kat Track and support bars on all Gullco track mounting devices...for firm perpendicular mounting of straight or curved rigid Kat Track or Flex-Track sections

PIVOTING TRACK MOUNTING DEVICE Model GK-190-110

Used to mount Gullco Flex-Track in Spherical Tank welding applications to maintain proper welding angle.

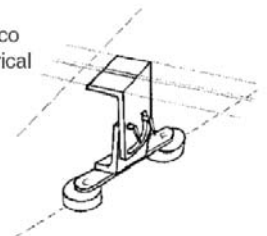

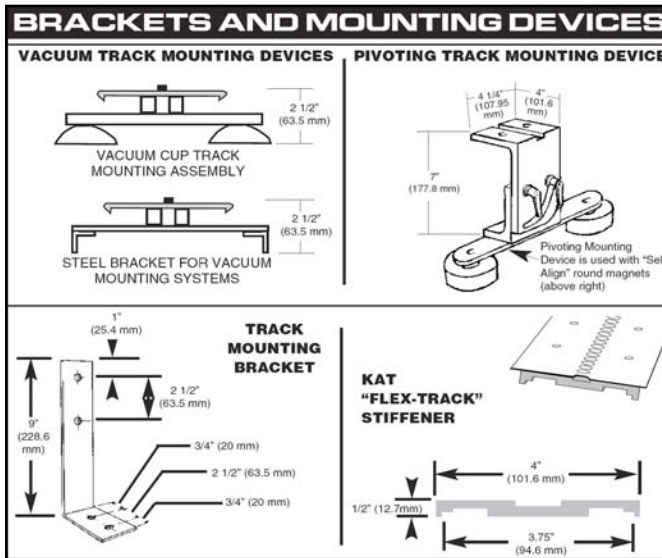
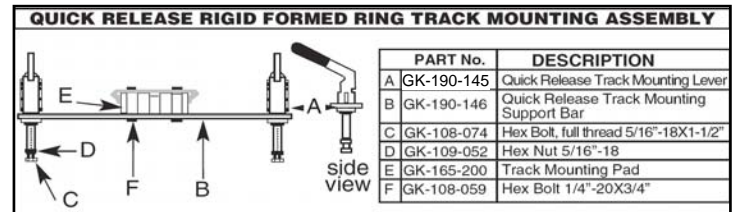
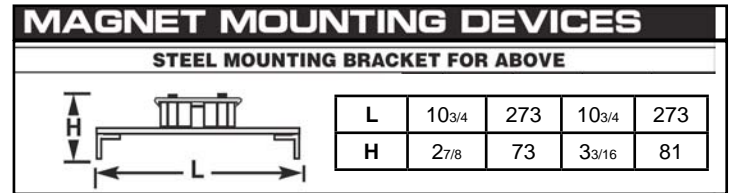
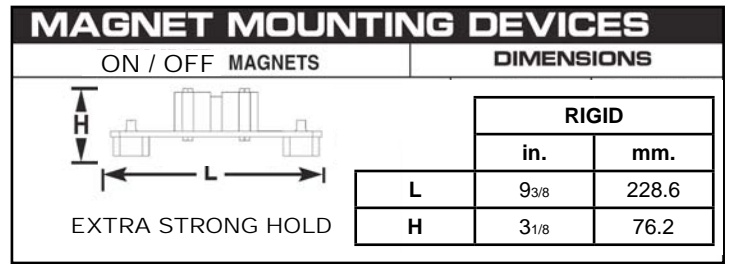
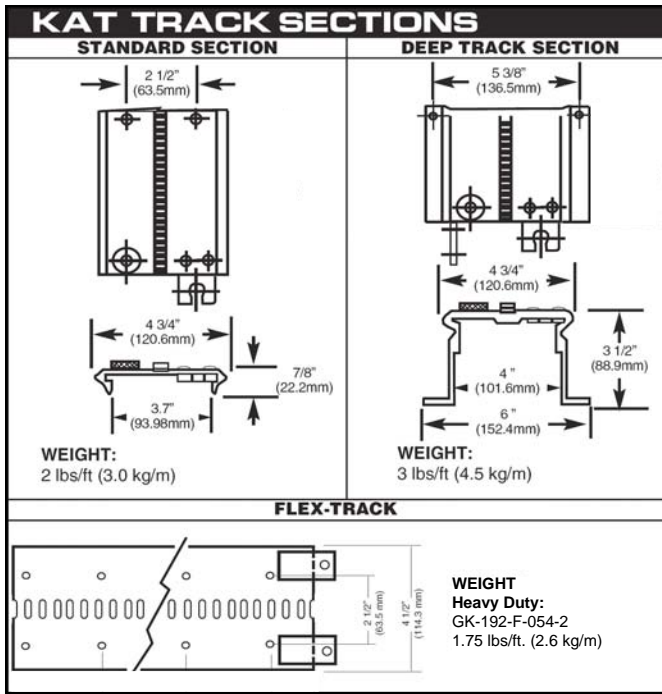

KAT, KBM, MOGGY, KATBAK & SAM are registered trademarks of Gullco Enterprises Limited

SPECIFICATIONS ARE SUBJECT TO CHANGE WITHOUT NOTICE. ALL DIMENSIONS ARE NOMINAL

Distributed by:

GULLCO		
CANADA - GULLCO INTERNATIONAL LIMITED		
Phone: 905-953-4140	Fax: 905-953-4138	e-mail: sales@gullco.com
U.S.A - GULLCO INTERNATIONAL INC.		
Phone: 440-439-8333	Fax: 440-439-3634	e-mail: ussales@gullco.com
EUROPE - GULLCO INTERNATIONAL (U.K.) LIMITED		
Phone: +44 1257-253579	Fax: +44 1257-254629	e-mail: uksales@gullco.com
AUSTRALIA - GULLCO INTERNATIONAL PTY LIMITED		
Phone: 61 (0)7 3348 5515	Fax: 61 (0)7 3348 5510	e-mail: ausales@gullco.com
INDIA - GULLCO INTERNATIONAL INDIA PVT LIMITED		
Phone: 91-20-6526-0382	Fax: 91-20-2683-6656	e-mail: indsales@gullco.com
CHINA - GULLCO INTERNATIONAL SHANGHAI LIMITED		
Phone: +8621-50460341	Fax: +8621-50463554	e-mail: c.zhang@gullco.com
SINGAPORE - GULLCO INTERNATIONAL LIMITED		
Phone: +65-9385-4468		e-mail: benny.lim@gullco.com
LATIN AMERICA - GULLCO INTERNATIONAL LIMITED		
Phone: 55-11-99485-1336		e-mail: rogerio.macedo@gullco.com
Stuch GmbH & Co. KG Schweisstechnik - GERMANY		
Phone: (02 03) 72 94 95	Fax: (02 03) 72 94 96	e-mail: info@stuch-schweisstechnik.de



VACUUM TRACK MOUNTING SYSTEM FOR KAT®



The Gullco vacuum mounting systems are designed to firmly hold the KAT Rigid and Flex Tracks in position on ferrous and non-ferrous materials. The systems are durable and dependable while incorporating a light weight design for portability. There are Vacuum/ KAT® carriage packages specifically designed for automatic welding and cutting applications.

Quick Setup Time - Lightweight Design - Portable

VACUUM SYSTEM FOR MOUNTING CARRIAGE TRACK ON NON-MAGNETIC MATERIALS

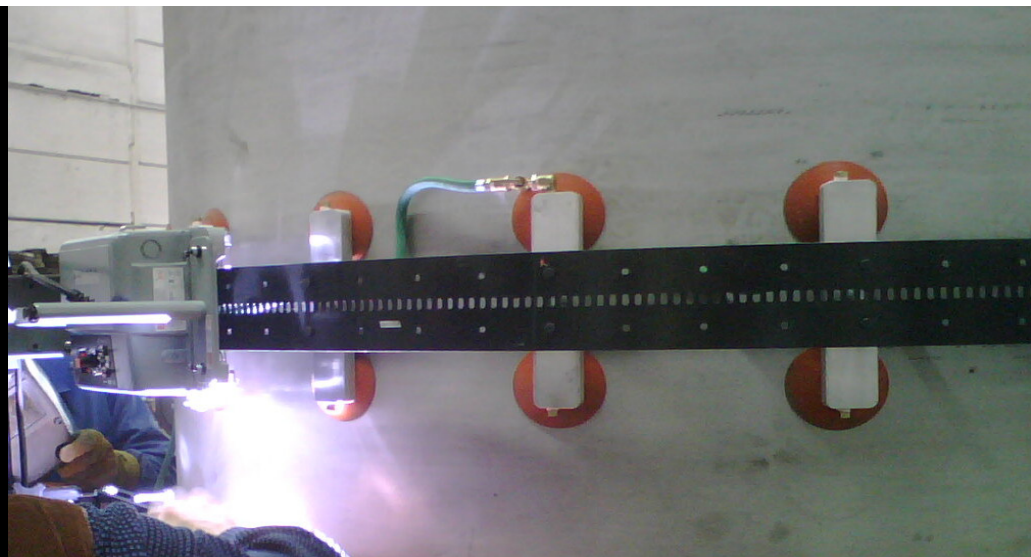

BASIC VACUUM MOUNTING COMPONENTS

Described on these pages are the vacuum systems that Gullco makes available for mounting KAT® Rigid Track and KAT® Flex Track on ferrous and non-ferrous materials.

The portable vacuum pump for these systems is described below. At right are the basic vacuum components used in both the rigid and flex track mounting assemblies. They are supplied by Gullco as complete, ready-to-use assemblies or as individual parts, either for standard lengths of track or for continuous runs of any specified length.



PORTABLE VACUUM UNIT Model GV-168-050

Comprised of electric motor driven, 2.4 cfm capacity vacuum pump mounted on cylindrical safety reservoir. Complete with vacuum gauge, filter, non-return valve, necessary fittings and 10 ft. (3048 mm) of flexible hose with quick disconnect coupling. *Recommended 3 pieces of **GK-165-054** Rigid or **GK-192-F-054-2** Flexible Track per vacuum pump.



VACUUM MANIFOLD BLOCK MOUNTING UNIT

Comprised of two vacuum cups, manifold block and mounting pad. The manifold has openings at each end and at the centre of each side for fittings required in assemblies such as hose connectors, couplings, valves and plugs. Heat resistance of the vacuum cup is 450°F for short durations and 350°F continuous. Minimum temperature is -40°F.

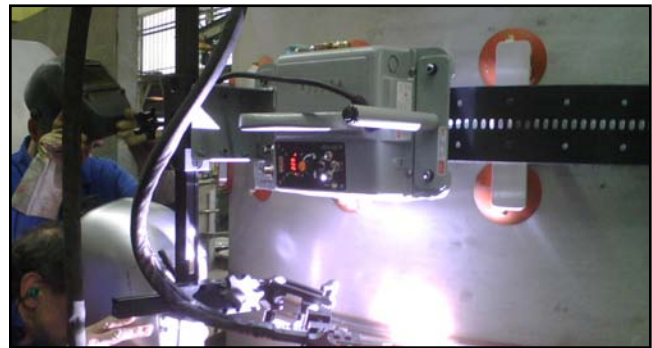

VACUUM MANIFOLD ASSEMBLIES

Link any number of Vacuum Block Mounting Units to provide a complete, in-line track mounting system. The end units are supplied with appropriate fittings for attachment to the pump or the next series of mounting units, while all "in-between" units have hose connectors on each side.

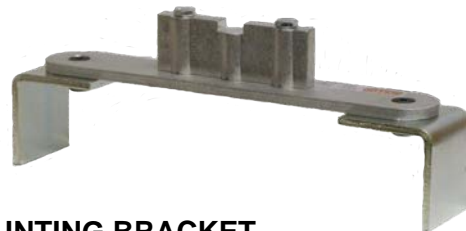

MOUNTING BRACKET

Comprised of mounting pad, support bar and two stainless steel mounting angle brackets. This component is primarily used to provide extra track stiffness to Flex-Track vacuum mounting assemblies and as tack welded support to provide an extra measure of safety in applications involving vertically mounted KAT® Rigid Track or Flex Track

FOR MOUNTING GULLCO RIGID KAT® TRACK

Gullco can supply a ready-to-use kit to vacuum mount KAT® Track, providing manifold block mounting units for mounting on 30" (761 mm) centers along with all appropriate hoses, fittings, etc.

For convenience, three kits are available for mounting standard 48", 96" and 120" (1219, 2438 and 3048mm) lengths of KAT® Track. They are described at right. It should be noted that these kits are supplied for use only with the designated track length. If lengths are to be joined, interconnecting fittings must be ordered.

3 lengths of 120" (3048mm) track can be handled by on vacuum pump (**Model GV-168-050**) depending on work surface finish.



Gullco Flex-Track is 8 ft. (2438 mm) and has holes for the attachment of manifold block mounting units and stainless steel mounting brackets. In some applications, the number of manifold block units may be safely reduced by using brackets so the number of each supplied will vary according to application requirements. For convenience, two kits are available for vacuum mounting KAT® Flex-Track, one meeting minimum stiffness requirements, the other providing standard stiffness.

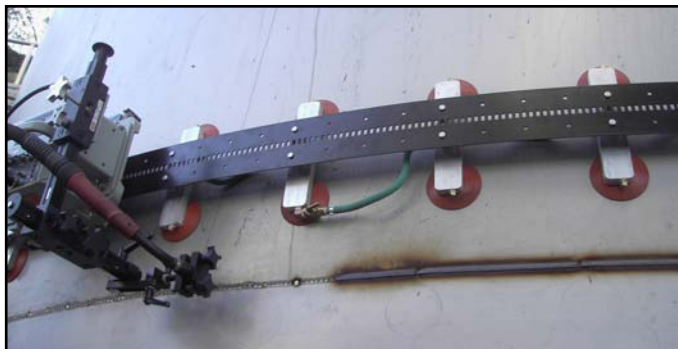

ASSEMBLIES FOR MOUNTING STANDARD LENGTHS OF KAT TRACK

Model GV-168-051-A for mounting 48" (1219mm) KAT Track comprised of 2 vacuum manifold block mounting units at 30" (761mm) centers complete with flexible hose between manifolds and male quick connect couplings for connecting the pump.

Model GV-168-053-A for mounting 96" (2438mm) KAT Track- as above, but 3 vacuum manifold block mounting units.

Model GV-168-070-A for mounting 120" (3048mm) KAT Track as above, but 4 Vacuum manifold block mounting units.

VACUUM MOUNTED HEIGHT KAT® Rigid Track

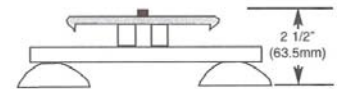

ASSEMBLIES FOR MOUNTING 96" (2438 mm) LENGTHS OF KAT® FLEX- TRACK

Model **GV-192-F-409** recommended for mounting on the heavy duty flex track, model **GK-192-F-054-2** comprised of 8 vacuum manifold block mounting units at 12" (304.8 mm) centers when complete with flexible hose between manifolds, intermediate shut-off valve and male quick connect coupling for connection to vacuum pump hose.

ASSEMBLIES FOR MOUNTING 96" (2438 mm) LENGTHS OF KAT FLEX TRACK

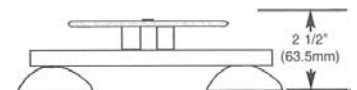

VACUUM MANIFOLD MOUNTING UNITS

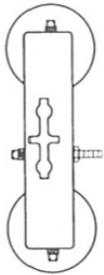

GV-168-083-2 (Blocked End)
Designed for use on the track section at the end of the vacuum mounting system run. Equipped with 1 mounting pad, 2 vacuum cups, 3 plugs and 1 hose connector

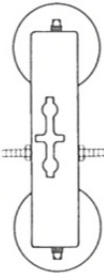

GV-168-055 (In Between)
Designed for use as the "in between" mounting units in both Rigid and Flex Track systems. Equipped with 1 mounting pad, 2 vacuum cups, 2 plugs and 2 hose connectors.

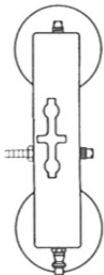

GV-168-083-1 (Connecting End)
Comprised of manifold block equipped with 1 disconnect coupling suited for connection to end of vacuum pump hose or to connect one track assembly to a second track assembly. Equipped with 1 mounting pad, 2 vacuum cups, 2 plugs and 1 male hose connector.

MOUNTING BRACKET

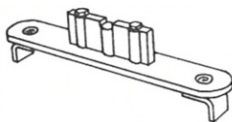

Model GV-192-F-410
Comprised of mounting pad, support bar and 2 stainless steel mounting angle brackets.

FITTINGS



FLEXIBLE HOSE CONNECTOR GV-168-071

For interconnecting vacuum mounted track sections 36" (914mm) long.



FLEXIBLE HOSE SECTIONS GV-168-072
used in various lengths to connect manifold assemblies. Secured by hose clamps
GV-192-F-076



PLUG
GF-168-007 for unused manifold openings



HOSE CONNECTOR
GF-168-005

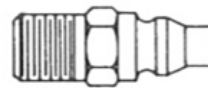

QUICK CONNECT COUPLING
GV-168-009

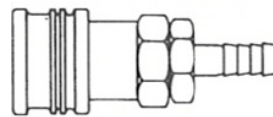

QUICK CONNECT COUPLING
GF-168-010

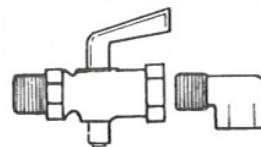

ON/OFF VALVE
Model GV-192-F-074
Used on-line or as required in Flex-Track Systems

KAT, KBM, MOGGY, KATBAK & SAM are registered trademarks of Gullco Enterprises Limited

Distributed by:

SPECIFICATIONS ARE SUBJECT TO CHANGE WITHOUT NOTICE. ALL DIMENSIONS ARE NOMINAL

GULLCO

CANADA - GULLCO INTERNATIONAL LIMITED

Phone: 905-953-4140 Fax: 905-953-4138 e-mail: sales@gullco.com

U.S.A - GULLCO INTERNATIONAL INC.

Phone: 440-439-8333 Fax: 440-439-3634 e-mail: ussales@gullco.com

EUROPE - GULLCO INTERNATIONAL (U.K.) LIMITED

Phone: +44 1257-253579 Fax: +44 1257-254629 e-mail: uksales@gullco.com

AUSTRALIA - GULLCO INTERNATIONAL PTY LIMITED

Phone: 61 (0)7 3348 5515 Fax: 61 (0)7 3348 5510 e-mail: ausales@gullco.com

INDIA - GULLCO INTERNATIONAL INDIA PVT LIMITED

Phone: 91-20-6526-0382 Fax: 91-20-2683-6656 e-mail: indsales@gullco.com

CHINA - GULLCO INTERNATIONAL SHANGHAI LIMITED

Phone: +8621-50460341 Fax: +8621-50463554 e-mail: c.zhang@gullco.com

SINGAPORE - GULLCO INTERNATIONAL LIMITED

Phone: +65-9385-4468 e-mail: benny.lim@gullco.com

LATIN AMERICA - GULLCO INTERNATIONAL LIMITED

Phone: 55-11-99485-1336 e-mail: rogerio.macedo@gullco.com

Stuch GmbH & Co. KG Schweisstechnik - GERMANY

Phone: (02 03) 72 94 95 Fax: (02 03) 72 94 96 e-mail: info@stuch-schweisstechnik.de



CLADDING AND OVERLAY SYSTEM - KAT® INDEXER

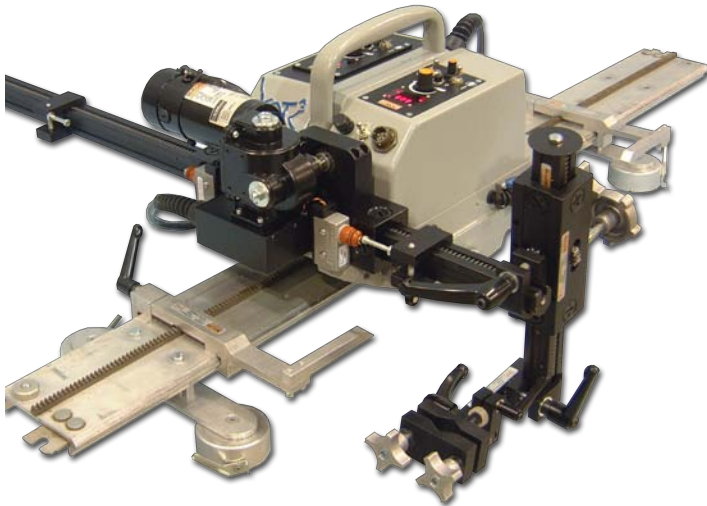

The Gullco KAT® Indexing System is typically used to automate single or multi-head overlay and cladding welding operations, hard surfacing, etc. The automatic routine drives a motorized device (either the KAT® carriage or the motorized rack arm), cycling back and forth between limit switches. When the device that is cycling reaches a limit switch, it pauses, and the other motorized device starts to index the gun/torch a preset distance in a preset direction allowing for consistent uniform weld patterns.

An Arc Signal Relay is supplied with the system to provide integrated arc activation signals to the overlay/surfacing equipment. Two Gullco Standard Platform (GSP) controls, each with dedicated microprocessor chips, are used to control the automatic, two axis indexing system. One GSP control is the Cycle Control and the other is the Index Control. Each control offers user programmable parameters and variables to allow fine tuning and functional control of the automatic cycle.

Gullco Indexing Systems, enable repetitive overlay- surfacing cycles to be preformed, with precise motion of the gun/torch from start to finish, regardless of the number of passes of the work pieces involved.



A Remote Control Pendants Is Available When Required

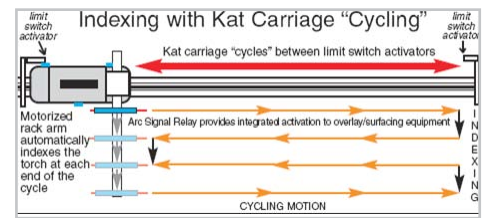
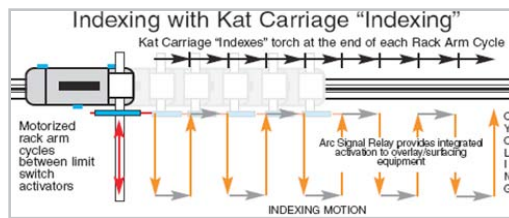

Automates Overlay and Cladding Welding Operations
 MODELS AVAILABLE FOR USE WITH RIGID AND FLEXIBLE TRACK SYSTEMS

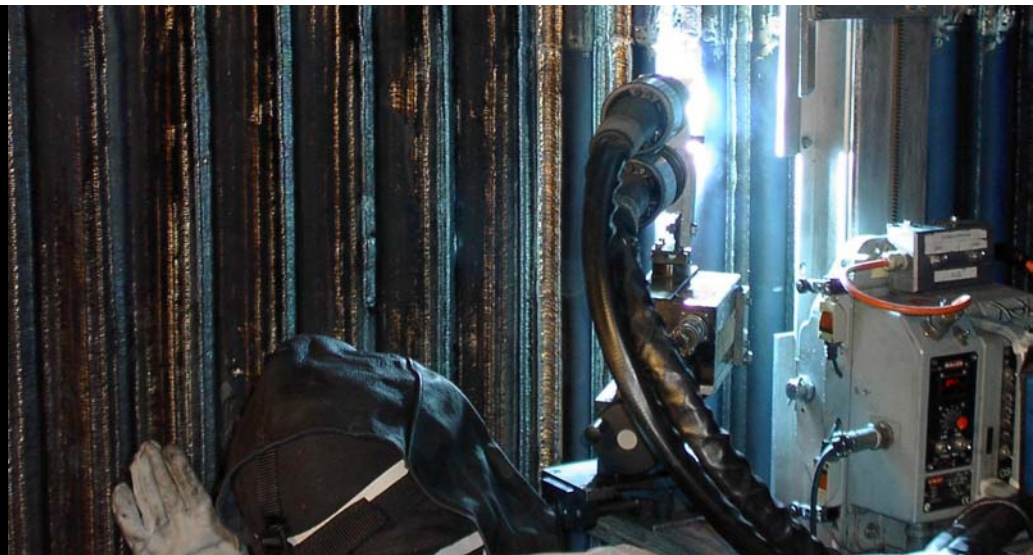

SPECIFICATIONS

Main Components: KAT® Travel Carriage (Flex KAT® for use on flexible track or Rigid KAT® for use on rigid track), KAT® Carriage/Indexer controls, Motorized Indexer Rack Box, Heavy Duty Rack Arm, Control Cable, Limit Switch activators for Carriage and Rack Arm, Torch Holder for standard MIG gun.

Controls: Two GSP controls mounted in the KAT®, each with dedicated microprocessor chips, are used to control the automatic, two axis indexing system. One drives the KAT® carriage; and one drives the motorized rack arm. They provide: Auxiliary wire feeder on/off, 16 Position Switch giving selectable index increments, Maximum travel of 24" (609 mm) using 36" (914 mm) long rack arm, Two Digit Display indicating the time that rack arm will index, KAT® Carriage Forward/ Reverse Switch and Carriage speed potentiometer, rack arm Jog Switch and Left/Off/Right switch, Auto On/Off switch, LED display.

Indexing Motorized Rack Box: Complete with limit switches and activators to prevent rack arm overrun, high torque gear motor to provide precise repeatability of the rack arm indexing distance. Standard assembly combines heavy duty 8" (203 mm) long rack box with 1-1/8" (29 mm) sq. x 36 (914 mm) long rack arm. Other lengths available.

Flex or Rigid KAT® Travel Carriage: with microprocessor pulse width modulation motor controls offering operator interface of forward, stop, reverse and infinitely variable control of the speed, within the range of the models. Travel speeds of the KAT® and rack box are electronically controlled using an optical tachometer on the back of each gear-motor. Through the use of this closed loop, feedback circuitry, each motor control can obtain accurate and constant speed control of the equipment when running in any plane, regardless of the load (within the rating of the equipment). The length of the KAT® travel path is pre-set by positioning the Track Stops at each end of the desired path. They engage and activate limit switches on the KAT® Travel Carriage to: automatically stop the travel carriage and reverse its movement, activate the control that indexes the rack arm and signals the welding gun to weld or not weld during indexing.

Safety is greatly enhanced by the use of Gullco's low voltage (24V), highly advanced controls and power supply system. Three line voltage inputs, 42, 115 and 230 VAC, single phase, 50/60 Hz, are available (see chart below).

RIGID KAT® AUTO-WELD

MODEL	SPEED RANGE
L	0.5 to 16.4 IPM (1.2 to 41.6 cm/min)
M	1 to 32.7 IPM (2.5 to 83.1 cm/min)
H	2.7 to 88.4 IPM (6.7 to 224 cm/min)

Select a speed range and voltage to determine your Rigid KAT® Indexer Model Number.

VOLTAGES	
MODEL	INPUT SUPPLY
A	42 VAC
B	115 VAC
C	230 VAC

REMOTE PENDANT CONTROL KIT

For use with the Rigid and Flexible Track KAT® Indexer System. Comprising of Remote Pendant (no control) attached to 8 ft. (843.84 cm) control cable on one end and KAT® control blanking plate on the other end with internal connectors at each end. This remote pendant uses the GSP controls removed from the KAT® Carriage. This kit can be easily field installed (or factory installed at no charge)

FLEX KAT® AUTO-WELD

MODEL	SPEED RANGE
L	0.8 to 25.8 IPM (2 to 65.4 cm/min)
M	1.5 to 51.5 IPM (3.9 to 131 cm/min)
H	4.2 to 139.1 IPM (10.6 to 353 cm/min)

Select a speed range and voltage to determine your Flex KAT® Indexer Model Number.

VOLTAGES	
MODEL	INPUT SUPPLY
A	42 VAC
B	115 VAC
C	230 VAC

Remote Control Indexer for Miscellaneous Rotation Equipment

Comprising of one (1) control box with switches for rack arm jog, cycle start and speed potentiometer. Index distance setting in a range from 0.01 to 9.99 in increments of 0.01. A single limit switch on 15 ft. (4572 mm) cable to provide 1/8" (29 mm) rack arm 36" (914 mm) long providing 24" (609 mm) of variable speed arm travel 1 to 32.7" (25 to 83.1 cm) per minute with limit switches to prevent rack arm over-travel and to stop the wire feeder. Two (2) adjustable rack arm limit switch stops and one (1) four-motion welding gun holder.



KAT, KBM, MOGGY, KATBAK & SAM are registered trademarks of Gullco Enterprises Limited

SPECIFICATIONS ARE SUBJECT TO CHANGE WITHOUT NOTICE. ALL DIMENSIONS ARE NOMINAL

Distributed by:

GULLCO		
CANADA - GULLCO INTERNATIONAL LIMITED		
Phone: 905-953-4140	Fax: 905-953-4138	e-mail: sales@gullco.com
U.S.A - GULLCO INTERNATIONAL INC.		
Phone: 440-439-8333	Fax: 440-439-3634	e-mail: ussales@gullco.com
EUROPE - GULLCO INTERNATIONAL (U.K.) LIMITED		
Phone: +44 1257-253579	Fax: +44 1257-254629	e-mail: uksales@gullco.com
AUSTRALIA - GULLCO INTERNATIONAL PTY LIMITED		
Phone: 61 (0)7 3348 5515	Fax: 61 (0)7 3348 5510	e-mail: ausales@gullco.com
INDIA - GULLCO INTERNATIONAL INDIA PVT LIMITED		
Phone: 91-20-6526-0382	Fax: 91-20-2683-6656	e-mail: indsales@gullco.com
CHINA - GULLCO INTERNATIONAL SHANGHAI LIMITED		
Phone: +8621-50460341	Fax: +8621-50463554	e-mail: c.zhang@gullco.com
SINGAPORE - GULLCO INTERNATIONAL LIMITED		
Phone: +65-9385-4468		e-mail: benny.lim@gullco.com
LATIN AMERICA - GULLCO INTERNATIONAL LIMITED		
Phone: 55-11-99485-1336		e-mail: rogerio.macedo@gullco.com
Stuch GmbH & Co. KG Schweisstechnik - GERMANY		
Phone: (02 03) 72 94 95	Fax: (02 03) 72 94 96	e-mail: info@stuch-schweisstechnik.de

MOTORIZED WELD TORCH POSITIONING ASSEMBLY



Improve the precision and efficiency of welding and cutting operations with these Gullco accessories. The motorized rack box moves the arm to the left or right and up or down when used vertically on command from a "joystick" equipped control box. A high speed override switch enables the operator to quickly position the torch prior to using low speed movement to follow the weld seam. Two assemblies can be combined to provide remote adjustment capabilities on both the X and Y axis, both controlled by a single joystick. The following components are used to provide assemblies suited to various applications requirements.

GK-190-214

An 8" (203mm) long, 1 1/8" (29mm) motorized rack box with adjustable nylastic bearing plugs, mounting holes suited to the Gullco KAT® carriage, a 24" (610mm) long 1 1/8" (29mm) rack arm and a 15 ft. (4572mm) control cable with quick disconnect plug for connection to the pendant control box.

GK-190-217

A 10" (254mm) long, 1 1/2" (38mm) extra heavy duty motorized rack box with adjustable nylastic bearings plugs, mounting holes suited to the Gullco KAT® carriage and a 24" (610mm) long, 1 1/2" (38mm) rack arm with one end turned to 1 1/8" (29mm) diameter. Includes control cable described above.

GK-190-201

Remote pendant control box for use with either of the above models. It features a joy stick that gives the operator precise control of rack arm movement in either direction, vertically or horizontally. The control incorporates direction indicator lights, high speed selector switch, and speed potentiometer providing infinite adjustment of rack arm movement between .5 and 35 IPM (1.27-89 cm/ min).

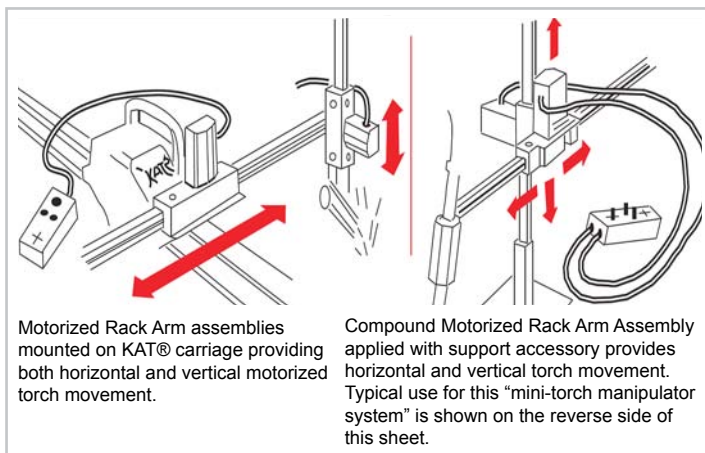

Remote Horizontal and Vertical Torch Adjustments

PRECISION WELD TORCH MOVEMENTS AUTOMATED WITH THIS MOTORIZED POSITIONING ASSEMBLY



SPECIFICATIONS

STANDARD APPLICATION

Gullco Motorized Rack Arm Assemblies provide an effective, precise manipulator system for positioning cutting torches or welding guns. A typical application is illustrated at right:

A Compound Rack Arm Assembly (either Model **GK-190-216 or 218**) is shown being used to cut or weld two sides of a square tube. Using the joy stick-equipped pendant control (Model **GK-190-201**), the vertically mounted box in the assembly moves up the arm to produce the vertical cut or weld. The arm of the second box is then extended to produce the horizontal cut or weld.

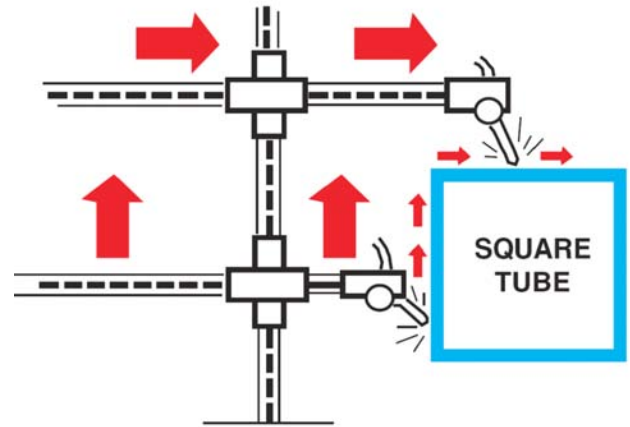

DIMENSIONS (PER DRAWING)

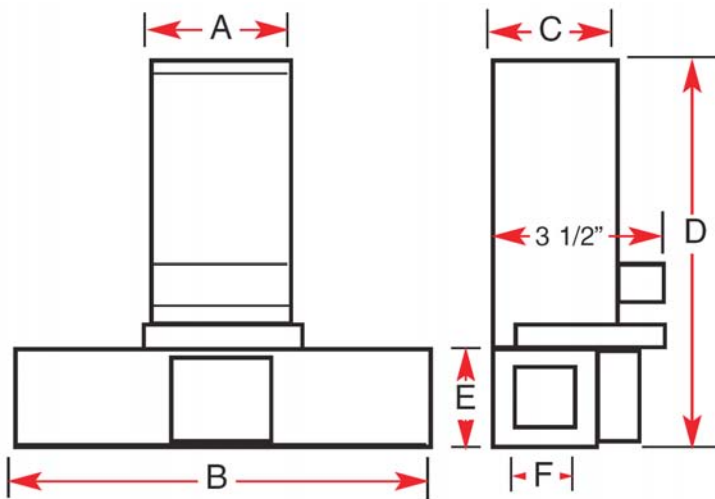

A		B		C		D		E		F	
in.	mm.	in.	mm.	in.	mm.	in.	mm.	in.	mm.	in.	mm.
3	76.2	8	203.2	2 3/4	69.85	7 3/8	187.3	2	50.8	1 1/8	28.57
3	76.2	10	254	2 3/4	69.85	7 7/8	200	2 1/2	63.5	1 1/2	38.1

Compound Assemblies:

Comprised of two motorized rack boxes mounted at right angles to provide up/down, in/out movement of two 24" (610 mm) long rack arms. Supplied with two 15 ft. (4572 mm) control cables.

GK-190-216

As above with 1 1/8" (29 mm) rack boxes and arms.

GK-190-219

1 1/2" (38 mm) rack boxes and arms.

The capacity of these motorized rack arms is 50 lbs. (20.4 kg) load vertical. The extra heavy duty 1 1/2" (38 mm) arm provides an additional 33% rigidity over the 1 1/8" (29 mm) arm. Safety is assured by the use of Gullco's low voltage (24 volt) micro processor based control system for operation in either 42, 110 or 230 volt A.C single phase 50/60 Hz power supply. Specify voltage when ordering.

Limit switches and longer rack arms and control cables are available on request. Gullco motorized rack arms can be readily adapted to any existing welding fixture for operations requiring infinite precise adjustment of the welding gun position.

KAT, KBM, MOGGY, KATBAK & SAM are registered trademarks of Gullco Enterprises Limited

Distributed by:

SPECIFICATIONS ARE SUBJECT TO CHANGE WITHOUT NOTICE. ALL DIMENSIONS ARE NOMINAL

GULLCO

CANADA - GULLCO INTERNATIONAL LIMITED
 Phone: 905-953-4140 Fax: 905-953-4138 e-mail: sales@gullco.com

U.S.A - GULLCO INTERNATIONAL INC.
 Phone: 440-439-8333 Fax: 440-439-3634 e-mail: ussales@gullco.com

EUROPE - GULLCO INTERNATIONAL (U.K.) LIMITED
 Phone: +44 1257-253579 Fax: +44 1257-254629 e-mail: uksales@gullco.com

AUSTRALIA - GULLCO INTERNATIONAL PTY LIMITED
 Phone: 61 (0)7 3348 5515 Fax: 61 (0)7 3348 5510 e-mail: ausales@gullco.com

INDIA - GULLCO INTERNATIONAL INDIA PVT LIMITED
 Phone: 91-20-6526-0382 Fax: 91-20-2683-6656 e-mail: indsales@gullco.com

CHINA - GULLCO INTERNATIONAL SHANGHAI LIMITED
 Phone: +8621-50460341 Fax: +8621-50463554 e-mail: c.zhang@gullco.com

SINGAPORE - GULLCO INTERNATIONAL LIMITED
 Phone: +65-9385-4468 e-mail: benny.lim@gullco.com

LATIN AMERICA - GULLCO INTERNATIONAL LIMITED
 Phone: 55-11-99485-1336 e-mail: rogerio.macedo@gullco.com

Stuch GmbH & Co. KG Schweisstechnik - GERMANY
 Phone: (02 03) 72 94 95 Fax: (02 03) 72 94 96 e-mail: info@stuch-schweisstechnik.de

Gouging System



KAT® Rigid Track Carriage - GK-200-RHB-N

Heavy-duty self-aligning wheel assemblies, closed loop tack feed-back for accurate speed control when running in any plane, regardless of load. (Maximum 100 lbs.) (45 kgs). The carriage is controlled by the Gullco low voltage 24 volt GSP microprocessor pulse width modulation motor control, interfacing with the forward/stop/reverse switch and infinitely variable 4-turn speed potentiometer. The LED display is in IPM or cm/min. The motor control can be upgraded to provide auto forward/reverse, limit switches and auto wire feed start.



Heavy-Duty Rack Box - GK-171-686

4" (101.6 mm) long with adjustable nylastic bearing plugs, for 1-1/8" (29 mm) square rack arm, with 3/8" threaded stud with 1-1/8" (29 mm) swivel clamp.



Heavy-Duty Rack Box - GK-171-650

6" (152.4 mm) long with adjustable nylastic bearing plugs, for 1-1/8" (29 mm) square rack arm.



18" (457.2 mm) long heavy duty 1-1/8" (29 mm) Square Rack Arm - GK-171-047-2

With rack and both ends turned to 1-1/8" (29 mm) diameter.



10-1/4" (260.3 mm) long 1-1/8" (29 mm) Square Rack Arm - GK-171-047-10.25

With rack and one ends turned to 1-1/8" (29 mm) diameter.



Gouging Torch Adaptor Stud Attachment - GK-200-017

The adaptor stud is used to facility the mounting of the gouging head to the rack arm.



Gouging Torch Adaptor Stud Attachment - GK-200-017

The adaptor stud is used to facility the mounting of the gouging head to the rack arm.

Gouging System Optional Accessories



Rigid Track Idler Carriage - GK-171-154

Complete with heavy duty self-aligning wheel assemblies providing 8-3/4" x 14-7/8" (222 mm x 378 mm) flat surface for mounting equipment and can be towed behind a KAT® Travel Carriage. (complete with a towing kit).



Rack Box Riser Bracket - GK-190-066

Provides an adjustable mounting surface – 2" (50.8 mm), 4" (101.6 mm) or 6" (152.4 mm) above the normal KAT® Carriage Rack Box mounting surface. System complete with mounting screws and can accommodate both rack boxes. Models GK-171-650 heavy duty 1-1/8" (29 mm) and GK-190-650 extra heavy duty 1-1/2" (38 mm).



Cable Support Assembly - GK-181-027

Provided with a swivel cable clamp for mounting on KAT® Carriage to prevent cable drag.

KAT, KBM, MOGGY, KATBAK & SAM are registered trademarks of Gullco Enterprises Limited

SPECIFICATIONS ARE SUBJECT TO CHANGE WITHOUT NOTICE. ALL DIMENSIONS ARE NOMINAL

Distributed by:

GULLCO		
CANADA - GULLCO INTERNATIONAL LIMITED	Phone: 905-953-4140	Fax: 905-953-4138 e-mail: sales@gullco.com
U.S.A - GULLCO INTERNATIONAL INC.	Phone: 440-439-8333	Fax: 440-439-3634 e-mail: ussales@gullco.com
EUROPE - GULLCO INTERNATIONAL (U.K.) LIMITED	Phone: +44 1257-253579	Fax: +44 1257-254629 e-mail: uksales@gullco.com
AUSTRALIA - GULLCO INTERNATIONAL PTY LIMITED	Phone: 61 (0)7 3348 5515	Fax: 61 (0)7 3348 5510 e-mail: ausales@gullco.com
INDIA - GULLCO INTERNATIONAL INDIA PVT LIMITED	Phone: 91-20-6526-0382	Fax: 91-20-2683-6656 e-mail: indsales@gullco.com
CHINA - GULLCO INTERNATIONAL SHANGHAI LIMITED	Phone: +8621-50460341	Fax: +8621-50463554 e-mail: c.zhang@gullco.com
SINGAPORE - GULLCO INTERNATIONAL LIMITED	Phone: +65-9385-4468	e-mail: benny.lim@gullco.com
LATIN AMERICA - GULLCO INTERNATIONAL LIMITED	Phone: 55-11-99485-1336	e-mail: rogerio.macedo@gullco.com
Stuch GmbH & Co. KG Schweisstechnik - GERMANY	Phone: (02 03) 72 94 95	Fax: (02 03) 72 94 96 e-mail: info@stuch-schweisstechnik.de

WWW.GULLCO.COM

N7500-12-01

WELDING AND CUTTING AUTOMATION

GULLCO

ARCAIR-MATIC N7500 GOUGING SYSTEM



The Arcair-Matic® N7500 gouging system is highly productive for any metal fabrication operation where gouging and welding represents a large portion of the work schedule. This applies to almost all metals, including stainless steel, carbon, manganese, and chrome-moly steels.

All functions can be controlled, from determining gouge parameters, start/stop function, travel delay, and the capability to manually feed or retract the electrode in the Torch Head. The operator can view the amperage and voltage during gouging sequence easily while maintaining the electrode on the weld seam that's being back gouged.

A single electrode contact shoe assembly accepts a full range of jointed electrodes from 5/16" (7.9 mm) through 3/4" (19.1 mm).

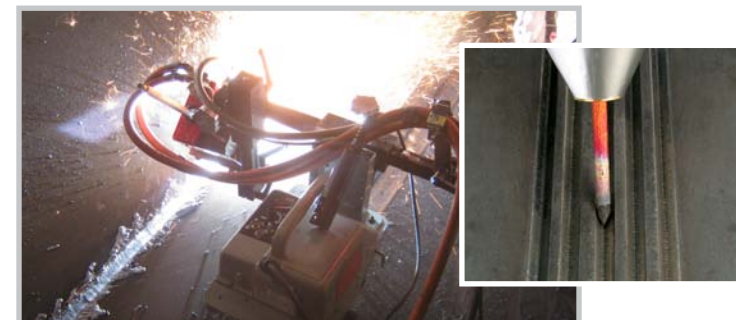

Five Times Faster, Ten Times Less Grinding

INSURE QUALITY AND CONSISTENCY WITH PRE-SELECTED GROOVE DEPTH

Arcair

GULLCO

WELDING AND CUTTING





KAT® Carriage System

- ★ Designed to operate on rigid or flexible track
- ★ Provides precise control of the application parameters
- ★ L.E.D Display for easy visibility of the application parameters during operation
- ★ Can be adapted for both Welding and Cutting applications

Digital LCD Remote Pendant



- ★ Ease of use – start/stop function, travel delay, electrode diameter
- ★ Rough machining feature to stall the feed of the electrode to compensate for pitted area or out-of-round steel rolls, thereby maintaining the concentricity of the shaft/roll
- ★ “Travel delay” function assures excellent groove geometry at the very beginning of the groove, thereby eliminating the need for a starting pad
- ★ Shock-absorbent bumper
- ★ Patent Pending

Torch Head

- ★ Redesigned Torch Head with an extended front end – gives the operator better view of the weld seam that’s being back-gouged
- ★ Can be oriented 360 degrees in any direction giving flexibility to fit the application



Digital Circuitry Control Box

- ★ Redesigned digital circuitry control box
- ★ A synergic mode ensures conformity to pre-determined, pre-selected groove depth and width specifications



Arcair®, an industry leader in air carbon-arc products, introduces the Arcair-Matic® N7500, a new and improved automatic gouging system that provides versatility, flexibility and safety features built with an enhanced gouging function. Combined with the KAT® Automated Carriage further improvements to productivity, consistency and quality are achieved.

Covering a broad range of applications, this automated gouging system can be utilized on almost all metals, including stainless steel, carbon, manganese, and chrome-moly steels. It is perfect for work with pressure vessels, wind towers, shipbuilding, railroads, bridge and girder manufacturing, and with heavy equipment used in mining industries.

As a bonus feature, use the remote pendant to track actual arc time to help schedule routine maintenance; additionally, it enables you to monitor and manage cost of the gouging project / job.

The remote pendant is enclosed in a splash-proof panel design to operate in high humidity/outside conditions and withstand impact from a distance of three feet.

The Arcair-Matic N7500 can be used with CC/CV power supplies available in the industry. It utilizes the contactor in the welding power supply unit thereby eliminating the need for the external contactor used in prior models.

One unit can service both US (120VAC) and International (220VAC) markets.

As a safety feature, “NO CURRENT” detect and low voltage functions that shut down the system when these conditions are sensed. These functions ensure optimum groove quality and prevent damage to the equipment and work.

ORDERING INFORMATION

Complete N7500 System

Includes Remote Pendant, Control Box and Torch Head (Part No. 65-991-015)



System Cable Assembly Options*

120V AC Power Supply Cable

Part No.	Description
96-130-304	10 ft (3 m)

220V AC Power Supply Cable

Part No.	Description
96-130-305	10 ft (3 m)

Pendant Cable Assembly

Part No	Description
96-170-069	14" (0.36 m)
96-170-070	15 ft (5 m)
96-170-071	25 ft (8 m)
96-170-072	50 ft (15 m)

Motor Cable Assembly

Part No.	Description
96-130-335	3 ft (0.9 m)
96-130-336	15 ft (5 m)
96-130-337	25 ft (8 m)
96-130-338	50 ft (15 m)

Power Supply Communication Cable Assembly

Part No.	Description
96-130-339	15 ft (5 m)
96-130-340	25 ft (8 m)
96-130-341	50 ft (15 m)

DC Power Cable

Part No.	Description
96-130-254	4 ft (1.2 m)
96-130-256	15 ft (5 m)
96-130-300	25 ft (8 m)

NOTE: Minimum 2 Power Cables Required

Air Hose Assembly

Part No.	Description
94-396-051	4 ft (1.2 m)
94-396-049	15 ft (5 m)
94-396-048	25 ft (8 m)

*Must be ordered separately

N7500 Assembly Set-Up

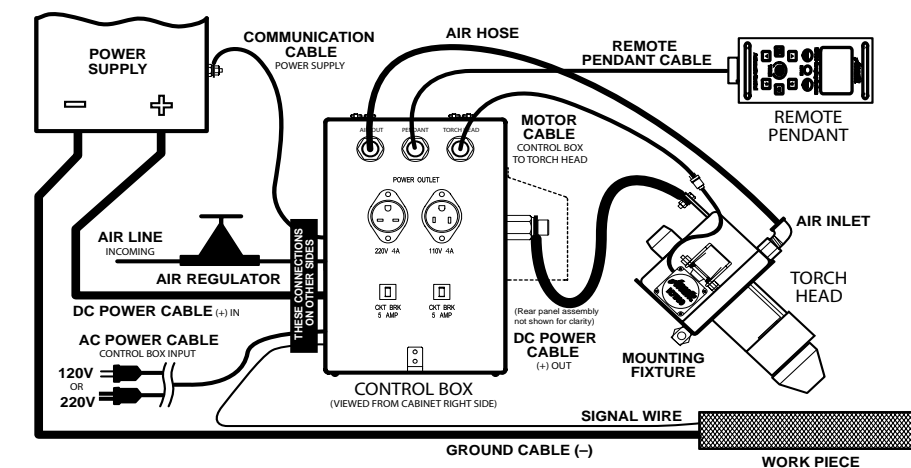



ORBITAL PIPE WELDING SYSTEM - PIPE KAT®

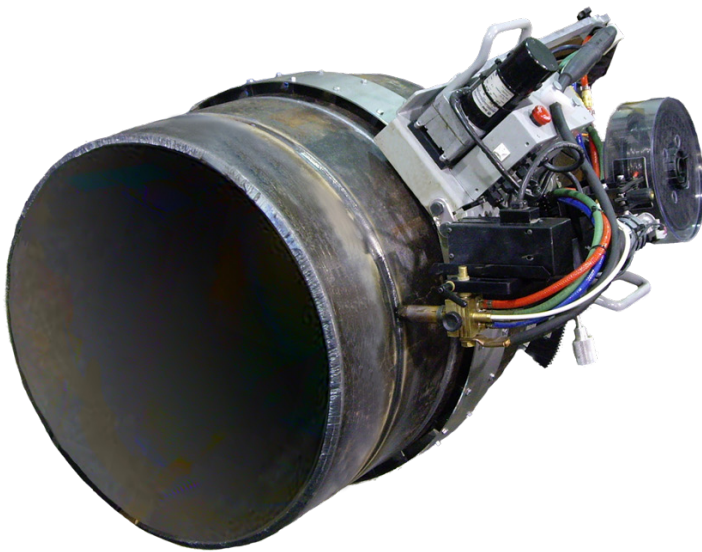

Carriage System Includes:

- Linear Oscillator
- Motorized Width Adjustment
- High Deposition Rate
- Simple Setup
- Easy to Use Controls
- High Speed Positioning (120 IMP / 3048 mm/min)

PK-200-B 115 Volt Model

PK-200-C 230 Volt Model



Increase pipe welding production and quality with this automation carriage

AUTOMATED PIPE WELDING SYSTEM WITH INTEGRATED WIRE FEEDER



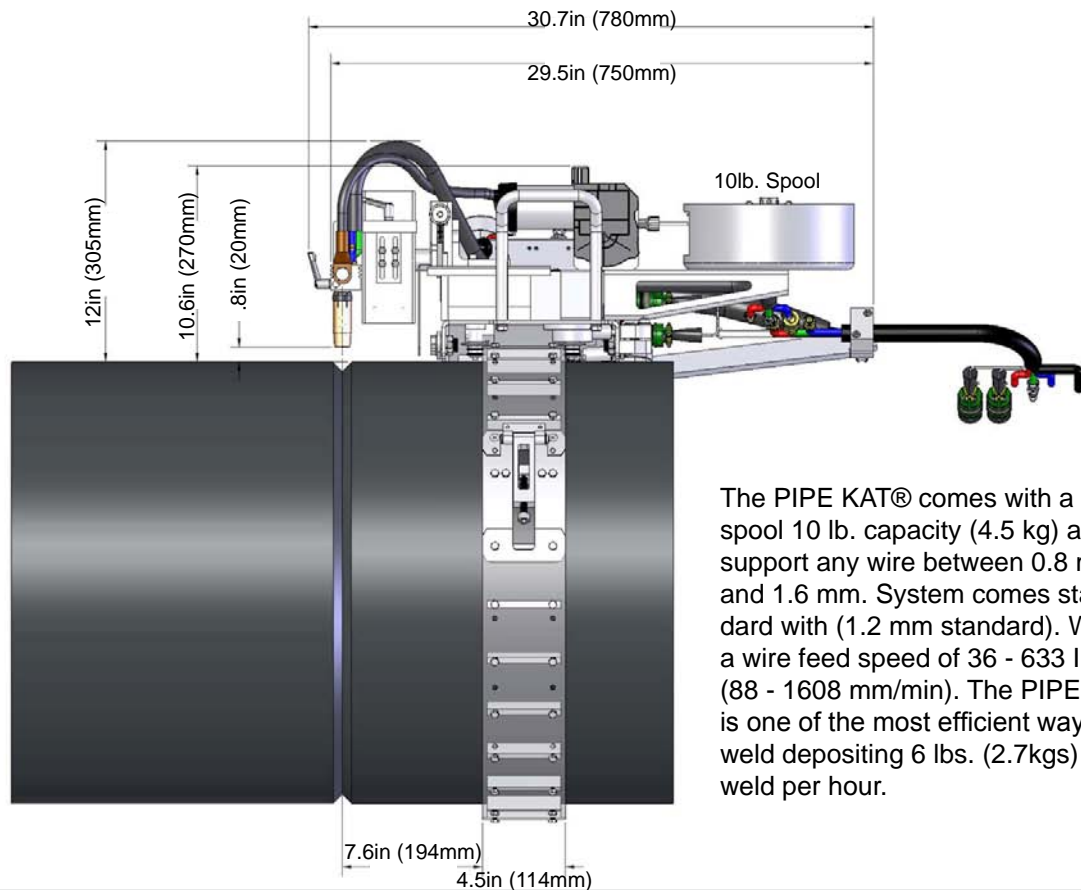

The PIPE KAT® comes with a wire spool 10 lb. capacity (4.5 kg) and can support any wire between 0.8 mm and 1.6 mm. System comes standard with (1.2 mm standard). With a wire feed speed of 36 - 633 IPM (88 - 1608 mm/min). The PIPE KAT® is one of the most efficient ways to weld depositing 6 lbs. (2.7kgs) of weld per hour.

The Gullco PIPE KAT® is a practical, affordable alternative to manual welding of heavy wall pipes 10" (254 mm) O.D and up. It produces x-ray quality welds with robotic consistency and precision, making it ideal for pipeline on-site work. The PIPE KAT® versatility allows it to work with various power sources, keeping overall costs low while still providing welds that meet code requirements. Total carriage weight less wire spool 42 lbs. (19 kgs). The unit is mounted on pipe by means of quick mount pipe band, which is available for all standard and custom pipe diameters. The welding torch is mounted on one side providing full open access to the weld joint area. The PIPE KAT® can be easily converted for straight line welding on tanks, shipbuilding, etc.

EASY STORAGE AND MOBILITY– PROTECTIVE CASE

The PIPE KAT® is shipped in a moisture resistant protective case which will protect the carriage and ensure that all of the components are kept secure. The PIPE KAT® and all of its components are protected by dense reusable foam, making it easy to both remove and replace the carriage and its accessories after the welding has been completed. (Shipping weight 145 lbs / 70 kgs including carriage)

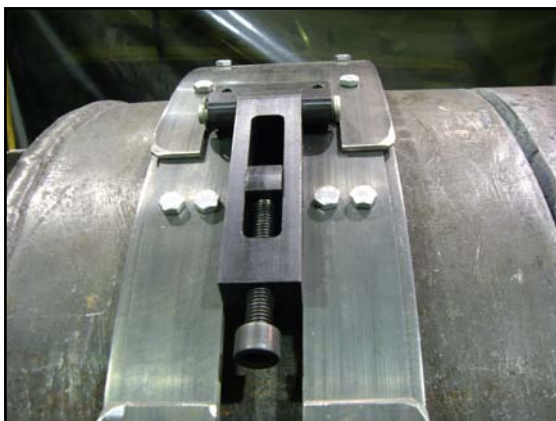

QUICK INSTALLATION TRACK DESIGN

The PIPE KAT® Orbital Welder uses a track design which utilizes a quick release band attachment to greatly decrease set-up time and improve the stability of the carriage during welding. Pipe bands are available from 10" (254 mm) outside diameter or larger.

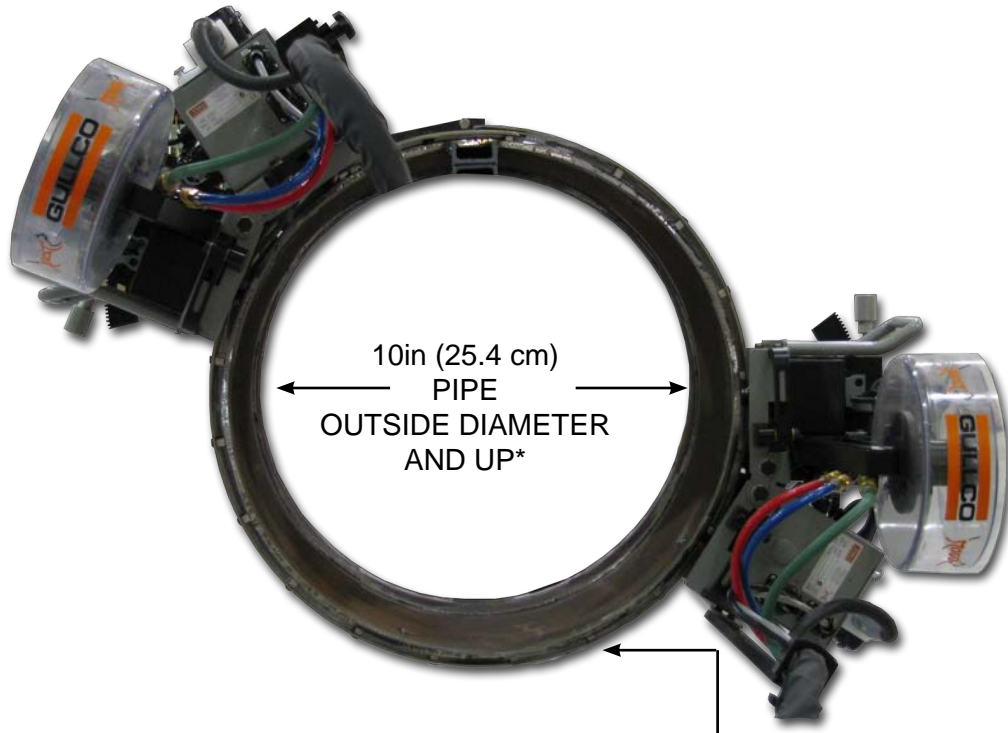

* ABOVE PICTURE ON 24in (61cm) PIPE

The PIPE KAT® unique design allows it to weld pipes as small as 10" (254 mm) O.D up to and including flat, horizontal or vertical welding. The PIPE KAT® is equipped with a linear oscillator. With the integrated wire feeder unit and the carriage incorporates 2.2 – 40 IPM (5.6-1016 mm/ min) welding carriage design with quick action mounting for ease of installation. The carriage is equipped with a high speed return feature for fast repositioning. A linear oscillator with adjustable weave width joint centerline adjustment and motorized vertical slide. All motorized functions incorporate jog settings. The system comes with a main control box on 25 ft. (7620 mm) of umbilical and remote pendant with 35 ft (10.5 m) of cable. Wire feed spool capacity of 10 lbs (4.5 kg) with a wire speed range of 36-633 IPM (88-1608 mm / min). Wire size range from 0.8 mm to 2 mm. The welding torch uses standard consumables.

DETERMINING THE PIPE BAND PART NUMBER

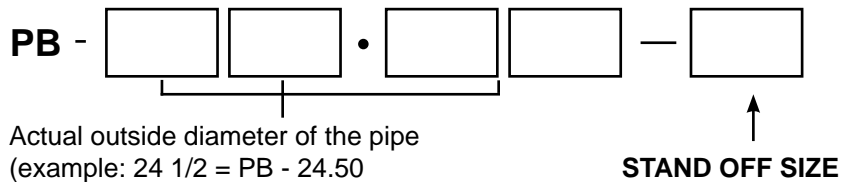

A	B	C	D	E	F	G
3/4" (19.0mm)	1" (25.4mm)	1 1/2" (38.1mm)	2" (50.8mm)	2 1/2" (63.5mm)	3" (76.2mm)	3 1/2" (88.9mm)



CUTTING ATTACHMENTS AVAILABLE

The PIPE KAT® is a versatile carriage and can be modified in order to complete cutting applications. Using our rack box and rack arm system the PIPE KAT® is able to make clean precise cuts whether it is flame beveling or horizontal cutting.





WELD SAMPLES



WELD TORCH AND WIRE INFORMATION:

The welding torch uses standard consumables, Bernard, Tregaskis or Binzel, air cooled or water cooled. Wire feed 10 lb. (4.5 kg) spool capacity. Maximum wire speed of 36 - 633 (88 - 1608 mm/min) with a size range of .8 to 2mm

REMOTE HAND PENDANT

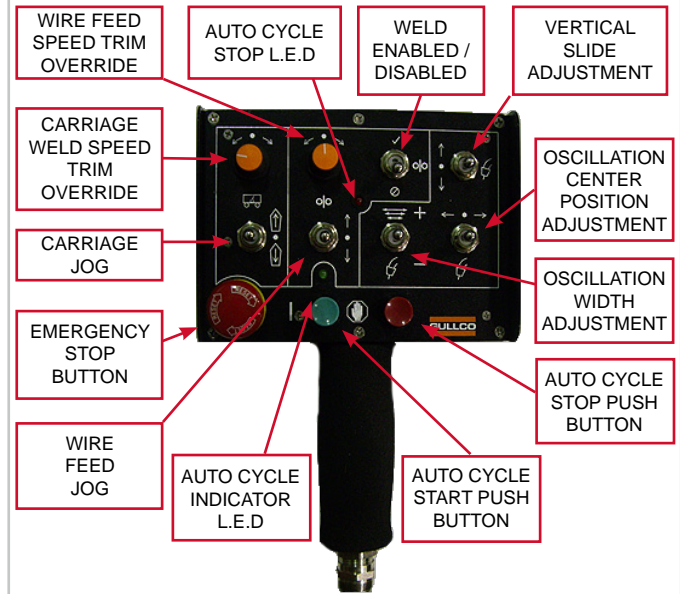

Remote pendant on 35 ft. (10.6 m) of cable incorporates carriage speed and jog, wire feed speed and jog, vertical slide adjustments, oscillation width and centerline adjustment with start/stop and emergency stop buttons. Optional extensions cable 15 ft. (4570 mm).

GULLCO PIPE KAT® CARRIAGE CONTROL

Includes:

- Motorized Width Adjustment
- High Speed Return
- Motorized Weld Head Joint Positioning
- Motorized Vertical Slide
- High Speed Carriage Jog
- Up/Down Jog Switch
- Wire Feed Jog
- Weld Enabled / Disabled Switch
- Auto Start Warning Buzzer

CARRIAGE CONTROL



KAT, KBM, MOGGY, KATBAK & SAM are registered trademarks of Gullco Enterprises Limited

SPECIFICATIONS ARE SUBJECT TO CHANGE WITHOUT NOTICE. ALL DIMENSIONS ARE NOMINAL

Distributed by:

GULLCO		
CANADA - GULLCO INTERNATIONAL LIMITED	Phone: 905-953-4140 Fax: 905-953-4138	e-mail: sales@gullco.com
U.S.A - GULLCO INTERNATIONAL INC.	Phone: 440-439-8333 Fax: 440-439-3634	e-mail: ussales@gullco.com
EUROPE - GULLCO INTERNATIONAL (U.K.) LIMITED	Phone: +44 1257-253579 Fax: +44 1257-254629	e-mail: uksales@gullco.com
AUSTRALIA - GULLCO INTERNATIONAL PTY LIMITED	Phone: 61 (0)7 3348 5515 Fax: 61 (0)7 3348 5510	e-mail: ausales@gullco.com
INDIA - GULLCO INTERNATIONAL INDIA PVT LIMITED	Phone: 91-20-6526-0382 Fax: 91-20-2683-6656	e-mail: indsales@gullco.com
CHINA - GULLCO INTERNATIONAL SHANGHAI LIMITED	Phone: +8621-50460341 Fax: +8621-50463554	e-mail: c.zhang@gullco.com
SINGAPORE - GULLCO INTERNATIONAL LIMITED	Phone: +65-9385-4468	e-mail: benny.lim@gullco.com
LATIN AMERICA - GULLCO INTERNATIONAL LIMITED	Phone: 55-11-99485-1336	e-mail: rogerio.macedo@gullco.com
Stuch GmbH & Co. KG Schweisstechnik - GERMANY	Phone: (02 03) 72 94 95 Fax: (02 03) 72 94 96	e-mail: info@stuch-schweisstechnik.de

ORBITAL WELDING CARRIAGE - PIPE KAT® - RIGID TRACK



Carriage Features and Benefits Include:

- Linear or Radial Oscillation
- Remote Voltage Adjustment
- Motorized Width Adjustment
- High Deposition Rate
- Simple Setup
- Easy to Use Controls
- Gas or Water Cooled Models
- Upto 2.5" (6.35 cm) Oscillation Width

PK-500-LG/RG - GAS/AIR COOLED

PK-500-LW/RW - WATER COOLED



Self Contained Orbital Welding System

AUTOMATE AND IMPROVE PIPE WELDING AND ORBITAL WELDING APPLICATIONS





SPECIFICATIONS:

Carriage Weight: 48 lbs (21 kg)

Control Box Weight: 30 lbs (13.6 kg)

Power Requirements: 42, VAC, 115 VAC, 230 VAC
Models available. Power consumption = 400 watts

Carriage Travel Speed: 1.35" - 44.2" (3.42 cm - 112.27 cm) Per Minute

Torch Adjustment: +/- 10°

Oscillation Speed: 0.5" - 140" (1 cm - 355.6 cm) Per Minute

Dwell Times: 0 to 9.9 seconds

Manual Slide Adjustment: 3" (7.62 cm) Vertical

Motorized Torch Adjustment: 2" (5.08 cm) Vertical

Oscillation Width Adjustment: 4" (10.16 cm) total slide adjustment. Max. oscillation width of 2.5" (6.35 cm)

Welding Spool Size: 8"/10 lbs (20.3 cm/4.5 kg)

Operating Temperatures: 0 to 60°C (32 - 140°F)

Wire Feeder Drive Rolls: 0.8 mm to 1.6 mm V-groove wheels, 1.0 mm to 2.0 mm V-groove knurled wheels (1.0/1.2 mm V-groove knurled comes standard, see chart on reverse for available options)

Carriage Umbilical: 25 ft. (7.6 m) in length and protected by a 500°C (932°F) rated cover. Contains torch power cable, shielding gas hose, carriage power cable, arc start cable, and water hoses if equipped

Compatible Welding Processes: All standard CV & CC processes, MIG, TIG, Pulse

Comes with Pipe KAT® Waterproof Carrying Case made by Pelican

The Pipe KAT® is a pipe welding carriage designed for orbital welding. It is an electrically powered track guided carriage that operates in the forward or reverse directions at precisely controlled speeds. The carriage operates on a track band made of durable aluminum extrusion by engaging the track with self-aligning wheels and a rack and pinion drive. This wheel assembly uses a lever to engage that track making it very quick and simple to install the carriage.

The Pipe KAT® is a fully integrated welding system which comes with a wire feeder and wire spool holder. Driven by a 24 VDC motor which feeds wire to the welding torch at precisely controlled speeds. The wire spool holder accepts standard 8"/10 lbs (20.3 cm/4.5 kg) spools.

A remote control pendant is provided to allow adjustment of the critical application parameters during the welding process including, oscillation width, speed, dwells, wire feed speed and voltage adjustment.

CARRIAGE ACCESSORIES

CARRIAGE UMBILICAL

25ft (7.6 m)
Carriage Umbilical
Extension Assembly

PK-500-163-G
PK-500-163-N
PK-500-163-W

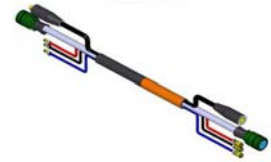

WATER COOLER POWER INTERFACE KIT

Interface allows control to automatically activate / deactivate water cooler during auto-cycle. Toggle switch included for manual override.

PK-200-216-A 42V
PK-200-216-B 115V
PK-200-216-C 230V



FLOW SWITCH KIT

Flow switch is used to monitor coolant flow to welding torch.

PK-500-177

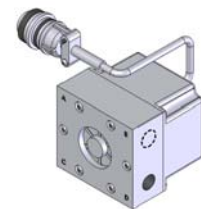

PENDANT EXTENSION CABLE

15 ft (4.6 m) Extension Cable.

PK-200-368



CARRIAGE CONTROL LAYOUT

REMOTE HAND PENDANT

- CARRIAGE WELD SPEED TRIM OVERRIDE
- WELDING VOLTAGE CONTROL
- WIRE FEED JOG
- WIRE FEED SPEED TRIM OVVERRIDE
- CARRIAGE JOG
- WELD ENABLED/DISABLED
- OSCILLATION WIDTH ADJUSTMENT
- TORCH SLIDE JOG
- EMERGENCY STOP
- OSCILLATOR CENTER POSITIONER ADJUSTMENT
- RED & GREEN L.E.D.s
- AUTO CYCLE START PUSH BUTTON
- AUTO CYCLE STOP PUSH BUTTON

CARRIAGE CONTROL

The Remote pendant (left) is used in conjunction with the main control (right) to provide adjustment during setup, initiate the weld cycle, provide fine adjustment during welding, and to stop the weld cycle.

The remote pendant is supplied with a 35ft communication cable that connects to the right side panel of the PIPE KAT® Main Control.

PIPE BAND ORDERING INFORMATION

PB-500- -

Pipe Outside Diameter (inches)
(2 Decimal Places)

Stand-off Height (inches)
Standard = 1.75" (4.45 cm)
up to 6.00" (15.24 cm)
(2 Decimal Places)

EXAMPLE 1:

If the Pipe Outside Diameter (O.D) is 22.357" with a stand-off of 3.5" the part number will be: **PB-500-22.38-3.50**

EXAMPLE 2:

If the Pipe O.D is 24" with a standard stand-off the part number will be: **PB-500-24.00-1.75**

NOTE:

- Stand-off heights over 1.75" (4.45 cm) require spacers. Min. spacer height of 0.50" (1.27 cm)
- All stand-offs are adjustable to +/- 0.157" (4 mm) using the 5 mm allen tool
- Min. \varnothing Track Datum = 17.5" (44.45 cm) [\varnothing Track Datum = \varnothing pipe + (2 x Stand-off Height)]
- Max. \varnothing Track Datum = 60" (152.4 cm) [Consult Factory For Larger Dimensions]

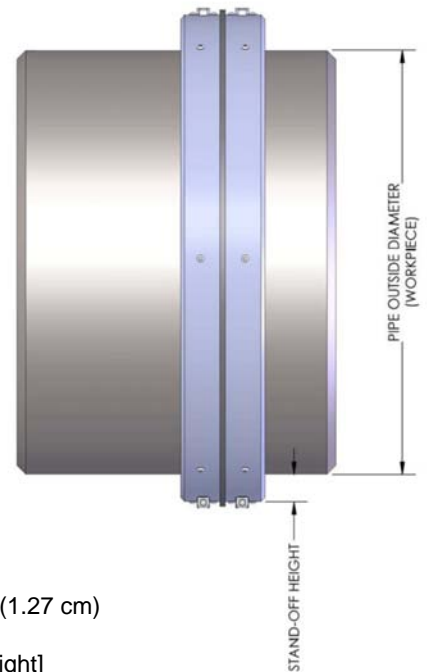

Quick Installation Track Band:

The hinged design of the Pipe KAT® track band makes installation simple and quick.

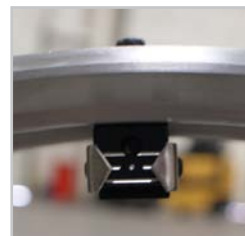

Adjustable Track Mounting Pads:

The Pipe KAT® band comes with stand off pads which allow for +/- 0.157" (4 mm) of adjustment.

PK-500-LG/RG

For use with gas/air cooled welding torch necks and consumables. Additional items are required.

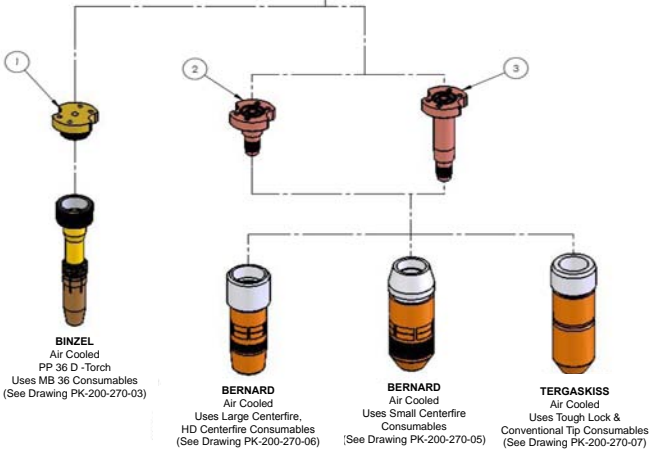

PK-500-LW/RW

For use with water cooled welding torch necks and consumables. Additional items are required.

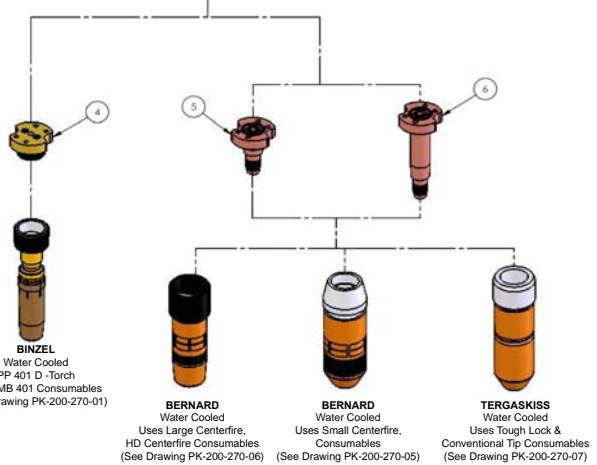

WIRE FEEDER ROLL ORDERING SPECIFICATIONS



PART #	DESCRIPTION	QTY.
PK-200-035-10	Feed Roll V-groove 0.8 mm + 1.0 mm	2
PK-200-035-12	Feed Roll V-Groove 1.0 mm + 1.2 mm	2
PK-200-035-16	Feed Roll V-Groove 1.2 mm + 1.6 mm	2
PK-200-035-12-K	Feed Roll V-Groove 1.0 mm + 1.2 mm Knurled	2
PK-200-035-14-K	Feed Roll V-Groove 1.2 mm + 1.4 mm Knurled	2
PK-200-035-20-K	Feed Roll V-Groove 1.6 mm + 2.0 mm Knurled	2

*The Pipe KAT® has a selection of feeder rolls available for different requirements. The Pipe KAT® comes standard with PK-200-035-12

PIPE KAT® PART NUMBER CONFIGURATION

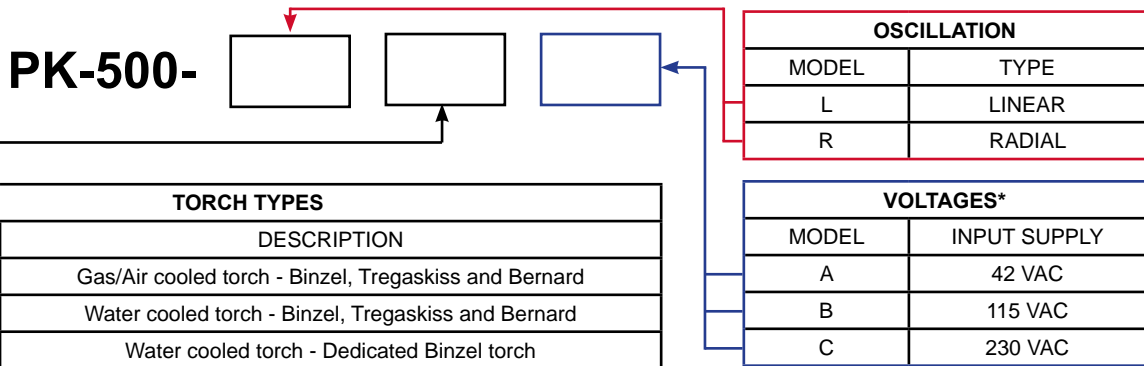

* All above voltage supplies are single phase, 50/60 hz, 400 watts

KAT, KBM, MOGGY, KATBAK & SAM are registered trademarks of Gullco Enterprises Limited

SPECIFICATIONS ARE SUBJECT TO CHANGE WITHOUT NOTICE. ALL DIMENSIONS ARE NOMINAL

Distributed by:

GULLCO

CANADA - GULLCO INTERNATIONAL LIMITED
Phone: 905-953-4140 Fax: 905-953-4138 e-mail: sales@gullco.com

U.S.A - GULLCO INTERNATIONAL INC.
Phone: 440-439-8333 Fax: 440-439-3634 e-mail: ussales@gullco.com

EUROPE - GULLCO INTERNATIONAL (U.K.) LIMITED
Phone: +44 1257-253579 Fax: +44 1257-254629 e-mail: uksales@gullco.com

AUSTRALIA - GULLCO INTERNATIONAL PTY LIMITED
Phone: 61 (0)7 3348 5515 Fax: 61 (0)7 3348 5510 e-mail: ausales@gullco.com

INDIA - GULLCO INTERNATIONAL INDIA PVT LIMITED
Phone: 91-20-6526-0382 Fax: 91-20-2683-6656 e-mail: indsales@gullco.com

CHINA - GULLCO INTERNATIONAL SHANGHAI LIMITED
Phone: +8621-50460341 Fax: +8621-50463554 e-mail: c.zhang@gullco.com

SINGAPORE - GULLCO INTERNATIONAL LIMITED
Phone: +65-9385-4468 e-mail: benny.lim@gullco.com

LATIN AMERICA - GULLCO INTERNATIONAL LIMITED
Phone: 55-11-99485-1336 e-mail: rogerio.macedo@gullco.com

Stuch GmbH & Co. KG Schweisstechnik - GERMANY
Phone: (02 03) 72 94 95 Fax: (02 03) 72 94 96 e-mail: info@stuch-schweisstechnik.de



AUTOMATED OSCILLATION WELDING CARRIAGE - KAT®



Ideal for heavy fabrication industries such as: Shipbuilding, Tank Welding, Pipeline and Bridge Construction

Motorized weld center line adjustment

Motorized stroke width adjustment

Precise oscillation speed control

Stores up to 10 different weld programs for quick recall of frequently used processes

Linear or Radial Oscillation Capability

ALL POSITION WELDING AND CUTTING AUTOMATION CARRIAGE



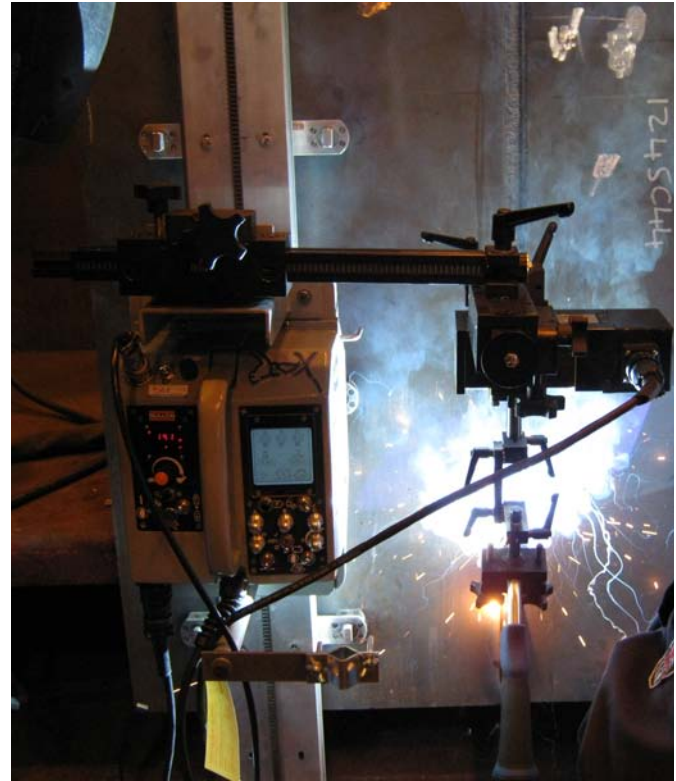

Models For All-Positions, Flat or Curved Surface Weld Oscillation

The Gullco KAT® Oscillator Package is comprised of the compact oscillator head, controls, mounting brackets, connecting cable, 1-1/8" heavy duty micro fine rack boxes with rack arms for horizontal and vertical adjustments and standard MIG gun holder, together with a KAT® carriage for rigid track or flex track as shown above.

Model Series GK-200-F (left) is supplied with a Gullco KAT® specifically designed for operation on spring steel KAT® Flexible Track.

Model Series GK-200-R Combo (right) is supplied with a KAT® specifically designed for operation on rigid aluminum KAT® track.

All are equipped with the Gullco microprocessor-based programmable control with a closed loop feedback system for complete speed accuracy regardless of load [0-100 lbs. (45kgs)] when operating in any weld position.

Detailed information is provided on the back page of this brochure.

Also Available Are The Linear or Radial Separate Remote Controlled Compact Oscillator Assembly - Model GK-201-100-RC

This assembly is comprised of either radial or linear Oscillator Head with MIG gun holder, Remote Control Box, Control Cable (up to 20ft), Micro Fine Rack Boxes, Rack Arms, and Brackets. It can be mounted on existing KAT® All-Position Travel Carriages, Welding Head Manipulators, Side Beam Carriages, etc.



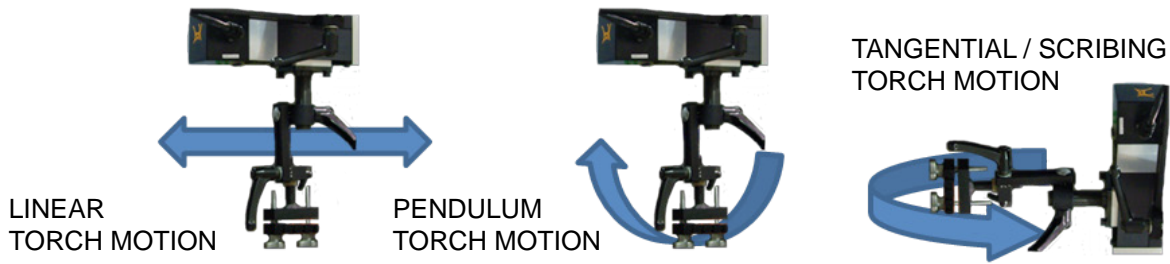

TANGENTIAL AND PENDULUM OR LINEAR MOTION

The oscillator heads are capable of producing three distinct motions when mounted in either the horizontal or vertical position. Shown in the above (right) is a tangential or scribing motion. The other, (middle) is a pendulum motion. Combined with the third linear straight line head they meet all welding oscillation requirements.

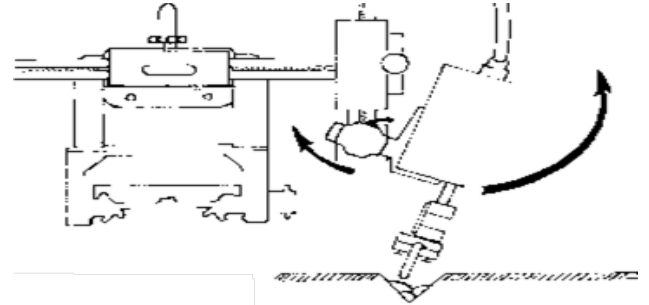

MOTORIZED CENTRELINE ADJUSTMENT

With independent, electronically controlled dwells (0-5 sec.) at each end of the stroke and at the centre of the stroke path.

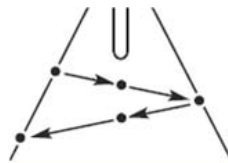

The proper torch angle/position is established quickly and easily with the Gullco KAT® Oscillator Head. It's simply a matter of tilting the oscillator, which can be adjusted side to side or forward and backward this results in the elimination of the time consuming and generally ineffective procedure of tilting the carriage or track.

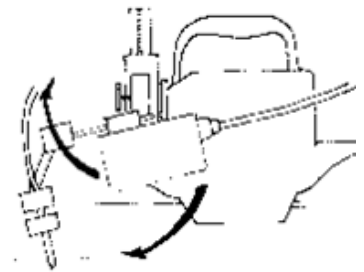

MOTORIZED STROKE WIDTH - Easy, precise adjustment to provide the required weld pattern.

OSCILLATION SPEED CONTROL- Oscillation speed is electronically controlled by a speed potentiometer (140 inches per minutes (linear) 45° per second (radial)).

Combining High Precision With Exceptional Versatility

High precision, state-of-the-art controls on the KAT® carriage automatically direct the desired forward/reverse movement or dwell of the welding gun and its oscillation motion to produce the numerous weld patterns shown below. The carriage control enables the carriage speed and direction to be pre-set and shown on its

LED display in IPM or cm/min. The oscillator controls enable pre-setting of the carriage delay/start after wire feed start, dwell times, stroke speed, stroke width, program storage and cycle start.

Control information is available on the following page



Some of the Weld Patterns Attainable With the KAT® Oscillator System

ANGULAR OSCILLATION PATTERN		STEP OSCILLATION PATTERN	
KAT CARRIAGE TRAVELS CONTINUOUSLY		KAT CARRIAGE TRAVELS ONLY DURING END DWELLS	
<p>WITH OSCILLATOR HEAD VERTICAL TO WORK</p>	<p>COMBINING OSCILLATION AND OSCILLATOR DWELL</p>	<p>Oscillation Head Vertical</p>	<p>Oscillation Head Horizontal</p>
<p>SPECIAL OSCILLATION</p> <p>Tilted - for welding on horizontal plane</p>	<p>Straight Line - Back and forth oscillation</p>		

OSCILLATOR CONTROL

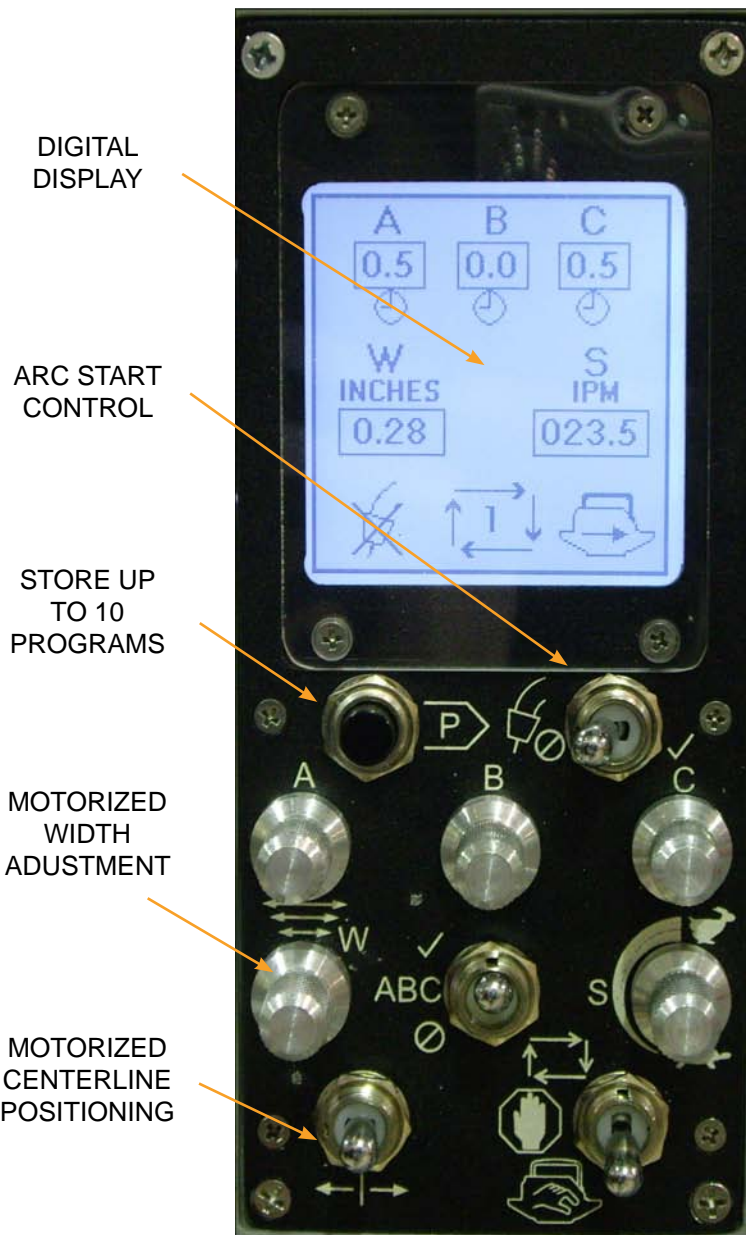

RADIAL OSCILLATOR



This advanced oscillation package is designed to increase production and improve the quality of the weld produced in automatic mechanized welding operations by minimizing weld defects such as poor penetration, incomplete fusion, overlap and undercut.

The GK-200 Series Compact Oscillator Carriage combination comes with the option for linear or radial oscillation head and can be equipped for use on either rigid or flexible track.

The oscillator is available with a linear, pendulum, tangential or step (square pattern) motion to the welding gun with adjustable motorized stroke width, infinitely variable stroke speed adjustment, three independent position dwell times, motorized centre line positioning and automatic wire feed start and travel start/stop interface.

By combining welding gun oscillation movement with the precision controlled travel speed of the Kat carriage, up to 10 weld programs can be produced and stored.

LINEAR OSCILLATOR

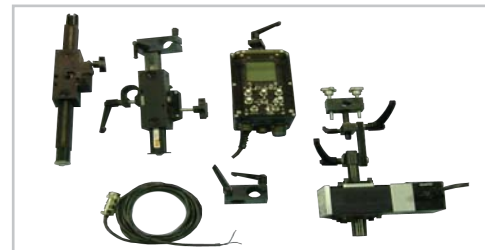

KAT, KBM, MOGGY, KATBAK & SAM are registered trademarks of Gullco Enterprises Limited

Distributed by:

WWW.GULLCO.COM

OSC-11-01

SPECIFICATIONS ARE SUBJECT TO CHANGE WITHOUT NOTICE. ALL DIMENSIONS ARE NOMINAL

GULLCO		
CANADA - GULLCO INTERNATIONAL LIMITED		
Phone: 905-953-4140	Fax: 905-953-4138	e-mail: sales@gullco.com
U.S.A - GULLCO INTERNATIONAL INC.		
Phone: 440-439-8333	Fax: 440-439-3634	e-mail: ussales@gullco.com
EUROPE - GULLCO INTERNATIONAL (U.K.) LIMITED		
Phone: +44 1257-253579	Fax: +44 1257-254629	e-mail: uksales@gullco.com
AUSTRALIA - GULLCO INTERNATIONAL PTY LIMITED		
Phone: 61 (0)7 3348 5515	Fax: 61 (0)7 3348 5510	e-mail: ausales@gullco.com
INDIA - GULLCO INTERNATIONAL INDIA PVT LIMITED		
Phone: 91-20-6526-0382	Fax: 91-20-2683-6656	e-mail: indsales@gullco.com
CHINA - GULLCO INTERNATIONAL SHANGHAI LIMITED		
Phone: +8621-50460341	Fax: +8621-50463554	e-mail: c.zhang@gullco.com
SINGAPORE - GULLCO INTERNATIONAL LIMITED		
Phone: +65-9385-4468		e-mail: benny.lim@gullco.com
LATIN AMERICA - GULLCO INTERNATIONAL LIMITED		
Phone: 55-11-99485-1336		e-mail: rogerio.macedo@gullco.com
Stuch GmbH & Co. KG Schweistechnik - GERMANY		
Phone: (02 03) 72 94 95	Fax: (02 03) 72 94 96	e-mail: info@stuch-schweisstechnik.de

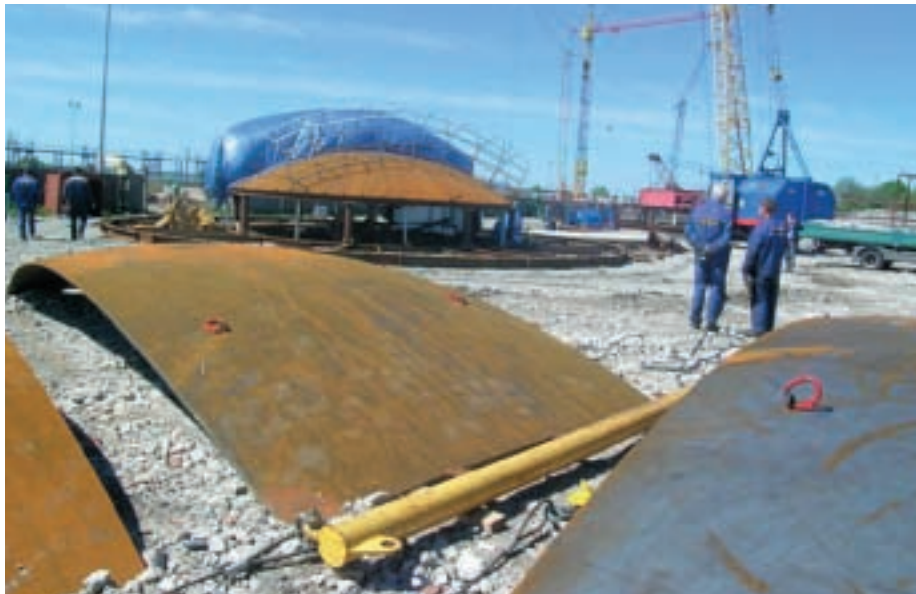

Gullco Flexible Track Kat Oscillator Combination & KATBAK Ceramic Weld Backing Enable “Single-Sided” Welding Of Spheres.

Kohimo Co. was able to reduce production time and improve weld quality in the production of spheres using Gullco products and technologies. In this project Kohimo was manufacturing 18 m. diameter spheres from 20 mm. thick

steel in Estonia. The method used in order to reduce production cost was single side welding, 60 deg. Incl angle 4-5 mm gap 2 mm root-face using 1.2 mm flux cored wire.

Gullco Flex Kat Oscillator Combination units running on flexible Kat Flex Track were used to perform the weld operation. This Gullco equipment combines welding gun oscillation movement with precise travel speed to produce a wide variety of angular and step weld patterns. The integrated control system directs both

Product Application File
 Flex Kat Oscillator Combo & KATBAK Ceramic Weld Backing
 For Sphere Welding

the Flex Kat carriage travel speed/direction and the weld gun movement/ operation. This enables pre-setting of stroke speed, oscillator and carriage dwell times and carriage delay/start after wire feed start. When combined with the precision controlled travel speed of the Kat carriage, a wide range of weld patterns can be produced. Gullco KATBAK Ceramic Weld Backings enabled X-ray quality root welds in one pass, full penetration welding from one side and uniform backbeads of finish quality. Inside the sphere, strong backs were used with cut-outs in them ...allowing

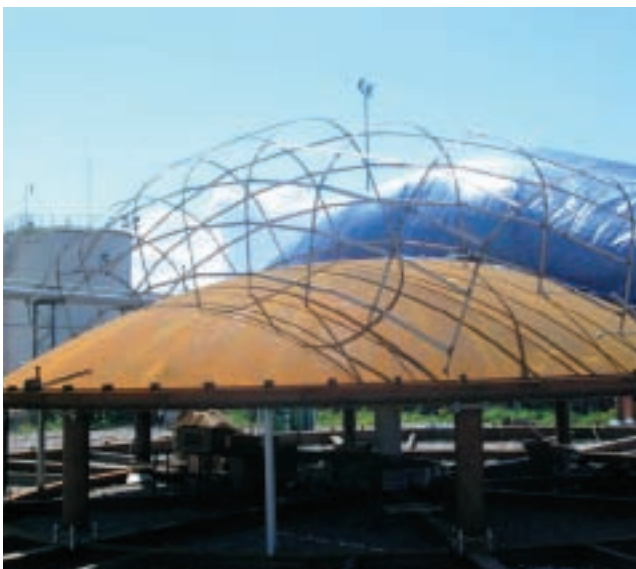

Above: The top of the sphere is “tented” to protect from wind and rain during construction of the spheres.



Above: Gullco Flex Kat Oscillator Combination runs on Gullco flexible track held in position using magnetic mounting assemblies



Katbak ceramics to be applied through. These strong backs maintained the shape of the sphere so that 100% weld penetration could be maintained.

Below: Strong backs with cut outs for KATBAK ceramic weld backings are used to provide 100% X-ray quality weld from one side.



Two Gullco Flex Kat Oscillator Combination units were mounted on a single flexible track working into the middle of the same joint. This, combined with the placement of Gullco 1G93-R Katbak ceramics on the inside of the vessel increased the quality and improved efficiency of the weld. This process resulted in the root side of the joint being as good as the outside with no defects and very few stops and starts in the joint.

Above: Gullco KATBAK with self-adhesive tape fits through cut outs in the strong backs. The use of KATBAK in this application enabled single sided welding (below) on the outside of the sphere...resulting in the root side of the joint inside the sphere (right) being as good as the outside.



The use of Gullco KATBAK can significantly reduce weld costs by eliminating the need for costly grinding, gouging and re-welding.



KAT, MOGGY, KATBAK & SAM are registered trademarks of Gullco Enterprises Limited

SPECIFICATIONS ARE SUBJECT TO CHANGE WITHOUT NOTICE

Distributed by:

GULLCO		
CANADA - GULLCO INTERNATIONAL LIMITED		
Phone: 905-953-4140	Fax: 905-953-4138	e-mail: sales@gullco.com
U.S.A - GULLCO INTERNATIONAL INC.		
Phone: 440-439-8333	Fax: 440-439-3634	e-mail: ussales@gullco.com
EUROPE - GULLCO INTERNATIONAL (U.K.) LIMITED		
Phone: +44 1257-253579	Fax: +44 1257-254629	e-mail: uksales@gullco.com
AUSTRALIA - GULLCO INTERNATIONAL PTY LIMITED		
Phone: 61 (0)7 3348 5515	Fax: 61 (0)7 3348 5510	e-mail: ausales@gullco.com
INDIA - GULLCO INTERNATIONAL INDIA PVT LIMITED		
Phone: 91-20-6526-0382	Fax: 91-20-2683-6656	e-mail: indsales@gullco.com
CHINA - GULLCO INTERNATIONAL SHANGHAI LIMITED		
Phone: +8621-50460341	Fax: +8621-50463554	e-mail: c.zhang@gullco.com
SINGAPORE - GULLCO INTERNATIONAL LIMITED		
Phone: +65-9385-4468		e-mail: benny.lim@gullco.com
LATIN AMERICA - GULLCO INTERNATIONAL LIMITED		
Phone: 55-11-99485-1336		e-mail: rogerio.macedo@gullco.com
Stuch GmbH & Co. KG Schweisstechnik - GERMANY		
Phone: (02 03) 72 94 95	Fax: (02 03) 72 94 96	e-mail: info@stuch-schweisstechnik.de

WWW.GULLCO.COM



Reprinted and Amended
From
Welding Design & Fabrication
September 2003

AUTOMATION AT SWAN HUNTER IMPROVES QUALITY AND EFFICIENCY

Swan Hunter (Tyneside) Ltd. of Wallsend, UK are in the process of building two Alternative Landing Naval ships for the Royal Fleet Auxiliary. When complete, the ships will transport troops, stores equipment and vehicles world-wide and deploy them into battle. They will also be suitable for disaster relief and other humanitarian missions.

One of the main challenges faced by Swan Hunter in this £140M project is to maintain high quality standards while at the same time reducing manufacturing costs and meeting tight delivery schedules. In order to meet these challenges, Swan Hunter had to review their



Gullco Kat Travel Carriages are used extensively to produce quality welds in all positions at the Swan Hunter Shipyard. Coupled with Gullco Oscillators, these units produce high quality mechanized welds in good production times.

production processes and identify areas where automation could be utilized.

During this process, weld prep and automated welding/cutting equipment manufactured by Gullco International was selected for several areas of production on their ships. Gullco is known throughout the world as a leader in the design and manufacture of reliable, cost reducing welding and cutting equipment.

The highly versatile KAT travel carriage system was selected for a variety of applications including positional cutting. It was found that, in this application, the KAT was able to produce cuts equal to those performed on “ground based” equipment. The benefit of the Gullco KAT is that it allows these quality cuts to be made in any position, including horizontal, vertical, and overhead. This greatly enhanced efficiency as cutting was easily integrated into the ship building process. Gullco KATs are also used for a wide variety of multi positional welding applications. Outfitted with Gullco Oscillators, these units provide high quality mechanized welds in all positions, including overhead. This greatly reduces production times while improving the quality of the welds. Swan Hunter also took advantage of the efficient Gullco Moggy trackless fillet



Alternative Landing Naval Ship under construction at Swan Hunter Tyneside Ltd. shipyard in Wallsend, England. When complete the ship will have an overall length of 176.6 m, a 26.4 m beam and deep displacement of 16,000 tons.

Swan Hunter & Gullco cont'd

welding machine in their stiffener welding operations. These units save hours of welding time and improve weld quality.

Plate edge preparation was another area of production that Swan Hunter was able to incorporate Gullco Technology. They decided to use Gullco GBM-18 high speed portable plate edge beveling machines. This decision was based on the GBM-18's ability to "cold cut" edge bevels, saving time and eliminating heat input to the plate...improving weld quality. This feature of the GBM-18 eliminates any heat affected zone that could be "hardenable" preventing potentially disastrous results in the welding of critical structures. The unit is operated by one man and is quiet and vibration free.

"Every modern" shipyard is now using ceramic weld backings in order to aid in weld quality and facilitate single sided welding. They chose Gullco "KATBAK"



Single sided welds were possible in many weld operations through the use of Gullco KATBAK ceramic weld backings. This improves weld quality and reduces weld time by as much as 50%.

ceramics for use. The product more than pays for itself as it enables high quality, single sided welding...producing x-ray quality back beads without costly grinding, gouging and re-welding. KATBACK's radiused edges enable use on flat or curved surfaces.

Swan Hunter and Gullco

International continue to find new ways of improving quality, reducing production time and adding efficiency in these ship building projects.

To date, Gullco equipment has proven to be very effective at the Swan Hunter shipyard and at other ship building operations around the world.

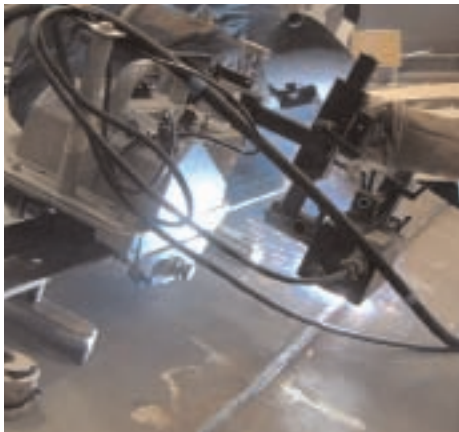

Above: Stiffener welding using Gullco Moggy trackless fillet welding machines.

Left: Capping pass weld using Gullco Kat Oscillator Combination.



Gullco series of GBM Plate Edge Bevellers provide clean machined bevels in preparation of welding.

Distributed by:

WWW.GULLCO.COM

GULLCO

CANADA - GULLCO INTERNATIONAL LIMITED

Phone: 905-953-4140 Fax: 905-953-4138 e-mail: sales@gullco.com

U.S.A - GULLCO INTERNATIONAL INC.

Phone: 440-439-8333 Fax: 440-439-3634 e-mail: ussales@gullco.com

EUROPE - GULLCO INTERNATIONAL (U.K.) LIMITED

Phone: +44 1257-253579 Fax: +44 1257-254629 e-mail: uk-sales@gullco.com

AUSTRALIA - GULLCO INTERNATIONAL PTY LIMITED

Phone: 61 (0)7 3348 5515 Fax: 61 (0)7 3348 5510 e-mail: aus-sales@gullco.com

INDIA - GULLCO INTERNATIONAL INDIA PVT LIMITED

Phone: 91-20-6526-0382 Fax: 91-20-2683-6656 e-mail: ind-sales@gullco.com

CHINA - GULLCO INTERNATIONAL SHANGHAI LIMITED

Phone: +8621-50460341 Fax: +8621-50463554 e-mail: c.zhang@gullco.com

SINGAPORE - GULLCO INTERNATIONAL LIMITED

Phone: +65-9385-4468 e-mail: benny.lim@gullco.com

LATIN AMERICA - GULLCO INTERNATIONAL LIMITED

Phone: 55-11-99485-1336 e-mail: rogerio.macedo@gullco.com

Stuch GmbH & Co. KG Schweisstechnik - GERMANY

Phone: (02 03) 72 94 95 Fax: (02 03) 72 94 96 e-mail: info@stuch-schweisstechnik.de



Fig 1. Large section of a ship being joined with Kat Oscillation.

Improvements in productivity and weld quality using the oscillator welding process

It has long been considered that the most productive and cost effective welding position within the shipbuilding industry is the flat position (PA). To satisfy this, great emphasis is put in at the design stage to maximize the use of this position. However, even when adopting this philosophy, welding has to be carried out in a variety of other positions. Many shipyards have found major benefits when welding a specific section of the ship hull in the overhead position (PE).

Carbon steel to carbon steel link-ups

Large block sections of the ship are welded together in the block build strategy, *fig 1*. On each section there are a large number of webs, girders and longitudinal connections to be made, in addition to the main hull connection. The bottom shell of the hull has traditionally been welded from the inside using a single V preparation, 60° inclusive angle 6mm gap feather edge with flat ceramic tiles on the outside to produce a single sided weld. This weld requires no back gouging treatment, and for a time was considered to be the most effective way if completing the connection. However, there were disadvantages such as:

- Welder access,
- Obstructions from webs, girders, etc, and

- potentially higher defect levels on multi pass runs passing through access gaps.

The alternative was to weld the connection from the outside, where a free run with minimum restrictions was available. This required reversing the preparation discussed earlier and welding the bottom shell of the ship in the overhead position. To achieve this the following was carried out:

- ◇ Joint rooted from the inside against a round ceramic tile, *fig 2*.
- ◇ Welding carried out from the outside using a *Kat Oscillator* and flux cored welding wire in the overhead (PE) position, *figs 3&4*.

As the joint moves from the bottom shell it undergoes the transition from the overhead

Product Application File “KAT” Welding Oscillation In Shipbuilding Environment

(PE) to the vertical (PG) position. The continuity of the weld is achieved using a flexible track. The weld is then continued up the side of the ship in the vertical position to the main deck, *fig 5* (on back page).

When the technique was evaluated against the previous practice, the planned manhours allocated to welding were decreased by 72%. In addition, the visual quality of the weld on both root and cap was of a very high standard.

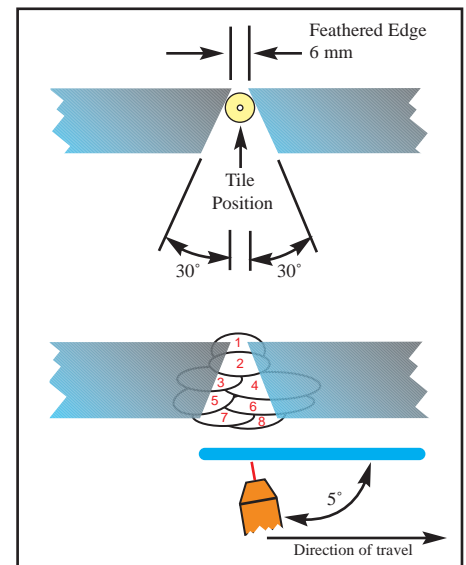

Fig 2. Joint rooted from the inside against a round ceramic tile

Fig 3. Welding carried out from the outside using a *Kat Oscillator* and flux cored welding wire in the overhead (PE) position





Fig 4. Welding in the overhead position using the Kat Oscillator and flux cored wire

Also radiography results are consistently better than the previous practice. These benefits could not have been achieved without the following key elements:

- ◆ A reliable oscillation system, and
- ◆ a high integrity flux cored wire.

To date the *Kat Oscillating System* has been found to be extremely reliable in the variety of positions and environments within the shipyard. Two flux cored wires are being used, both are of Japanese origin, one is copper coated seamless wire and the other is a more traditional seamed wire. Both wires are E71T-1 type and can be used in all welding positions.

This practice has developed from extensive experience gained elsewhere in the shipyard on carbon and stainless steel.

Stainless steel to stainless steel corrugated bulkheads

To date, four chemical carriers have been built. The cargo tanks are constructed from 316LN stainless steel, and are made up from a series

Fig 5. Continuing the weld up the side of the ship in the vertical position using the flexible track.



of corrugated bulkheads. The weld profile has to be as smooth as possible to remove potential sites for cargo retention. The oscillator welding process was put into operation, and resulted in extremely high quality welds with minimum surface discontinuities, *fig 6*. As the joint to be welded was fully tracked, welds were produced without any intermediate stop/starts which further reduced the potential for discontinuities, *fig 7*. As in the case of mild steel, the stainless steel FCAW wire was of Japanese origin.

The amount of potential back gouging was reduced by welding against a ceramic backing tile. On plate thickness of approximately 34mm, a 2/3 to 1/3 preparation was used with a round ceramic tile placed in the groove. It was found that a larger gap was required for stainless steel than for carbon steel, due to contraction effects. A gap of 8mm was used with the root run being applied with the oscillator. When the round tile was removed a good concave profile was obtained, which only required wire brushing prior to second side welding.

General

The use of the *Kat Oscillator* within shipbuilding has been increased significantly, and at present, procedures are available for almost all general welding positions. This includes the horizontal position (PC), which in the past has been particularly problematic, especially when rooting onto a ceramic backing tile. A further area being considered is the use of the *Oscillator track* to double up as an aid to radiography inspection. The X-ray head could be mounted onto the carriage and moved into position for shooting as required.

Summary

The work carried out to date with the



Fig 7. Oscillator welding process in operation joining 316LN stainless steel. This resulted in very high quality welds with minimum surface discontinuities. Furthermore, following the welding operation the *Kat Oscillator track* could be used for mounting an X-ray head for NDT inspection purposes

oscillator has shown:

- ◆ Significant improvements in productivity when used in conjunction with a compatible FCAW consumable.
- ◆ Significant reduction in back gouging can be achieved when welding against ceramic tiles.
- ◆ Transitional areas from the overhead to the vertical positions can be welded using flexible track
- ◆ High integrity stainless steel weld caps can be produced.
- ◆ The track could be used as an aid to NDT, by carrying an X-ray head.



Fig 6. Weld produced using the oscillator process in the overhead (PE) position.

KAT, MOGGY, KATBAK & SAM are registered trademarks of Gullco Enterprises Limited

SPECIFICATIONS ARE SUBJECT TO CHANGE WITHOUT NOTICE

Distributed by:

GULLCO

CANADA - GULLCO INTERNATIONAL LIMITED	Phone: 905-953-4140	Fax: 905-953-4138	e-mail: sales@gullco.com
U.S.A - GULLCO INTERNATIONAL INC.	Phone: 440-439-8333	Fax: 440-439-3634	e-mail: ussales@gullco.com
EUROPE - GULLCO INTERNATIONAL (U.K.) LIMITED	Phone: +44 1257-253579	Fax: +44 1257-254629	e-mail: uksales@gullco.com
AUSTRALIA - GULLCO INTERNATIONAL PTY LIMITED	Phone: 61 (0)7 3348 5515	Fax: 61 (0)7 3348 5510	e-mail: ausales@gullco.com
INDIA - GULLCO INTERNATIONAL INDIA PVT LIMITED	Phone: 91-20-6526-0382	Fax: 91-20-2683-6656	e-mail: indsales@gullco.com
CHINA - GULLCO INTERNATIONAL SHANGHAI LIMITED	Phone: +8621-50460341	Fax: +8621-50463554	e-mail: c.zhang@gullco.com
SINGAPORE - GULLCO INTERNATIONAL LIMITED	Phone: +65-9385-4468		e-mail: benny.lim@gullco.com
LATIN AMERICA - GULLCO INTERNATIONAL LIMITED	Phone: 55-11-99485-1336		e-mail: rogerio.macedo@gullco.com
Stuch GmbH & Co. KG Schweisstechnik - GERMANY	Phone: (02 03) 72 94 95	Fax: (02 03) 72 94 96	e-mail: info@stuch-schweisstechnik.de

WWW.GULLCO.COM



GULLCO



KAT® Welding Carriage System with Oscillator head combination used on multi weld application for UK Aircraft Carriers.

THE PROJECT

Recently commenced is a project that will see Gullco welding automation used to produce two UK Navy Air Craft carriers in the coming months. This shipyard in Cammell Laird, Merseyside has selected Gullco equipment after a list of companies where tested for their effectiveness to meet military welding inspection standards. It was agreed upon by the UK Shipyards that the automation equipment supplied by Gullco was the most reliable and most consistently met weld quality standards. It is important that the automation produce high integrity welds at an increased frequency to previous production methods in order to increase manufacturing efficiency. This project will see various types of welding applications throughout its completion and the welding technicians will utilize the versatility of the KAT all position carriage to produce the majority of these welding procedures.

THE CHALLENGE

The shipyard in Merseyside was faced with the task of producing 2 aircraft carriers under strict deadlines, with increasing quality standards. These issues are then compounded with having to source, and train welding technicians on the selected automation equipment which will be used to complete the project. Early on in this process it became apparent that finding reliable, easy to use weld automation equipment, which is coupled with great onsite ...

PRODUCT CASE STUDY FILE

UK NAVY Shipyard - Air Craft Carrier
Cammell Laird, Merseyside

THE EQUIPMENT

KAT – All position carriage, used in 1G, 2G, and 3G positions

MOGGY- Trackless carriage: Standard and Dual Torch models for continuous and stitch welds

KBM – 18 and 28 models for offsite steel suppliers, hand held model for out of position bevels

Cont.

...training and back end support, would be the critical challenge to the successful completion of this high profile project. This was combined with the challenge of having high integrity bevels, with consistent root face made off site by a 3rd party company who would produce the steel for the completion of the carriers.



Moggy® trackless welding carriage producing fillet welds.

THE SOLUTION

After several companies made proposals, the GULLCO International line of welding automation equipment was selected. This was in part due to its versatility. Through the use of a track and mounting device system the KAT carriage is able to operate in all positions, reducing the amount of equipment training necessary to complete a variety of weld applications. This was especially appealing when combined with onsite training provided by Gullco's welding technicians.

Another key factor to this solution was Gullco's great back end support team for both technical questions and equipment, giving them the peace of mind to put the automation to the test. The solution to the steel problem would be solved with a gift. The shipyard would purchase two KBM beveling machines from Gullco, which could produce the consistency necessary while eliminating material distortion and give them to the steel manufacturing facility in order to insure quality standards and regulations were met.



KAT® Welding Carriage System with Oscillator head combination used to complete long continuous weld in the flat position.

Cont.

Other equipment involved in this solution were, Moggy trackless friction drive carriages, used to produce the welds in the flat position, and a hand held beveling system for out of position beveling done during manufacturing. The extensive line of GULLCO automation equipment allowed the shipyard to source all of its products from one company streamlining the process which would carry over into efficient training sessions. It was also of benefit to know that support for the equipment could come from the one source and cover the range of equipment.



Moggy® Trackless Welding Carriage System completing structural fabrication on UK aircraft carrier.

To see the above products and more welding and cutting automation solutions visit www.gullco.com or send your application questions to sales@gullco.com

www.GULLCO.COM

KAT, MOGGY, KATBAK, & SAM are registered trademarks of Gullco Enterprises Limited

SPECIFICATIONS ARE SUBJECT TO CHANGE WITHOUT NOTICE

Distributed by:

GULLCO		
CANADA - GULLCO INTERNATIONAL LIMITED		
Phone: 905-953-4140	Fax: 905-953-4138	e-mail: sales@gullco.com
U.S.A - GULLCO INTERNATIONAL INC.		
Phone: 440-439-8333	Fax: 440-439-3634	e-mail: ussales@gullco.com
EUROPE - GULLCO INTERNATIONAL (U.K.) LIMITED		
Phone: +44 1257-253579	Fax: +44 1257-254629	e-mail: uksales@gullco.com
AUSTRALIA - GULLCO INTERNATIONAL PTY LIMITED		
Phone: 61 (0)7 3348 5515	Fax: 61 (0)7 3348 5510	e-mail: ausales@gullco.com
INDIA - GULLCO INTERNATIONAL INDIA PVT LIMITED		
Phone: 91-20-6526-0382	Fax: 91-20-2683-6656	e-mail: indsales@gullco.com
CHINA - GULLCO INTERNATIONAL SHANGHAI LIMITED		
Phone: +8621-50460341	Fax: +8621-50463554	e-mail: c.zhang@gullco.com
SINGAPORE - GULLCO INTERNATIONAL LIMITED		
Phone: +65-9385-4468		e-mail: benny.lim@gullco.com
LATIN AMERICA - GULLCO INTERNATIONAL LIMITED		
Phone: 55-11-99485-1336		e-mail: rogerio.macedo@gullco.com
Stuch GmbH & Co. KG Schweisstechnik - GERMANY		
Phone: (02 03) 72 94 95	Fax: (02 03) 72 94 96	e-mail: info@stuch-schweisstechnik.de

www.GULLCO.COM

CS-UKNAVY-10-01



GULLCO



KAT Oscillation carriage combination welding overhead on Scottish bridge construction.

PRODUCT CASE STUDY FILE

Overhead Welding (4G) with KAT® Oscillator Combination

THE PARAMETERS

- Travel speed: 22cm/min
- Arc Voltage: 24
- Amperage: 210
- Torch Angle: 5° - 10° pull
- Oscillation: root none, thereafter 4mm
- Side Dwells: none

THE PROJECT

The M74 completion project will complete a vital part of the west of Scotland's motorway network with a new eight kilometres (five miles) stretch of road continuing the M74 from Fullarton Road Junction, near Carmyle to the M8 motorway west of the Kingston Bridge. This project is part of a massive infrastructure investment in Scotland's transport network which includes a new rail link to Glasgow airport, a new rail link between Airdrie in the West and Bathgate in the East, and further improvements to the central Scotland motorway network. The M74 project is a partnership project between Transport Scotland, Glasgow City Council, South Lanarkshire Council and Renfrewshire Council.

THE APPLICATION

At first Cleveland Bridge approached Gullco to automate/mechanise the overhead welding of short welds in the workshop to eliminate the need to turn large beams risking twisting and bending of the beam as well as saving time. This was successful and the process was to be repeated on site where the need to automate was even greater with a large quantity of overhead welds to be performed on joints many meters in length. The welds are partial penetration butt joints of various depths from 15mm to 20mm on plates 50mm to 85mm thick with the first and second passes made in one run and thereafter split weaves to suit the joint.

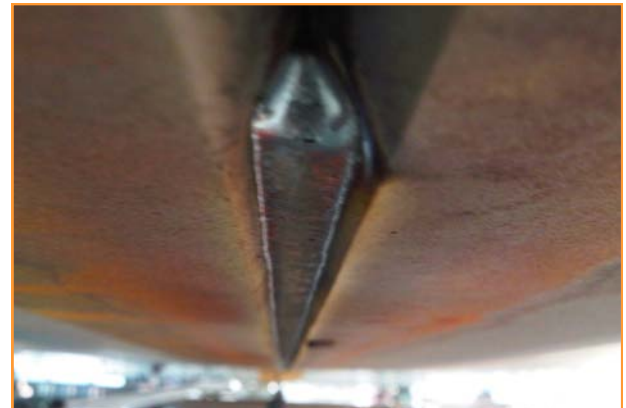

THE CHALLENGE

The brief was to use welding machines already in the possession of Cleveland Bridge, which is in line with Gullco policy as Gullco do not manufacture or supply welding machines, leaving the supply of such parts to their local distributor.

In addition the following was used:-

- Gullco Kat Oscillator Combination running on rigid track (flexi track also available)
- 1.2mm diameter gas shielded rutile flux cored wire
- Gas: Argon 80% CO2 20%

Cleveland Bridge are using 3 Kat® oscillator packages on a continuous basis on site in Glasgow.

Trevor Powley from Cleveland Bridge said: *"We are very happy with the Gullco product as well as after sales service and on site welder training"*.

KAT, MOGGY, KATBAK, & SAM are registered trademarks of Gullco Enterprises Limited

SPECIFICATIONS ARE SUBJECT TO CHANGE WITHOUT NOTICE

Distributed by:

GULLCO

CANADA - GULLCO INTERNATIONAL LIMITED

Phone: 905-953-4140 Fax: 905-953-4138 e-mail: sales@gullco.com

U.S.A - GULLCO INTERNATIONAL INC.

Phone: 440-439-8333 Fax: 440-439-3634 e-mail: ussales@gullco.com

EUROPE - GULLCO INTERNATIONAL (U.K.) LIMITED

Phone: +44 1257-253579 Fax: +44 1257-254629 e-mail: uksales@gullco.com

AUSTRALIA - GULLCO INTERNATIONAL PTY LIMITED

Phone: 61 (0)7 3348 5515 Fax: 61 (0)7 3348 5510 e-mail: ausales@gullco.com

INDIA - GULLCO INTERNATIONAL INDIA PVT LIMITED

Phone: 91-20-6526-0382 Fax: 91-20-2683-6656 e-mail: indsales@gullco.com

CHINA - GULLCO INTERNATIONAL SHANGHAI LIMITED

Phone: +8621-50460341 Fax: +8621-50463554 e-mail: c.zhang@gullco.com

SINGAPORE - GULLCO INTERNATIONAL LIMITED

Phone: +65-9385-4468 e-mail: benny.lim@gullco.com

LATIN AMERICA - GULLCO INTERNATIONAL LIMITED

Phone: 55-11-99485-1336 e-mail: rogerio.macedo@gullco.com

Stuch GmbH & Co. KG Schweisstechnik - GERMANY

Phone: (02 03) 72 94 95 Fax: (02 03) 72 94 96 e-mail: info@stuch-schweisstechnik.de

WWW.GULLCO.COM

CS-CLEV-10-01

ELECTRONIC SEAM TRACKING SYSTEM - KAT®

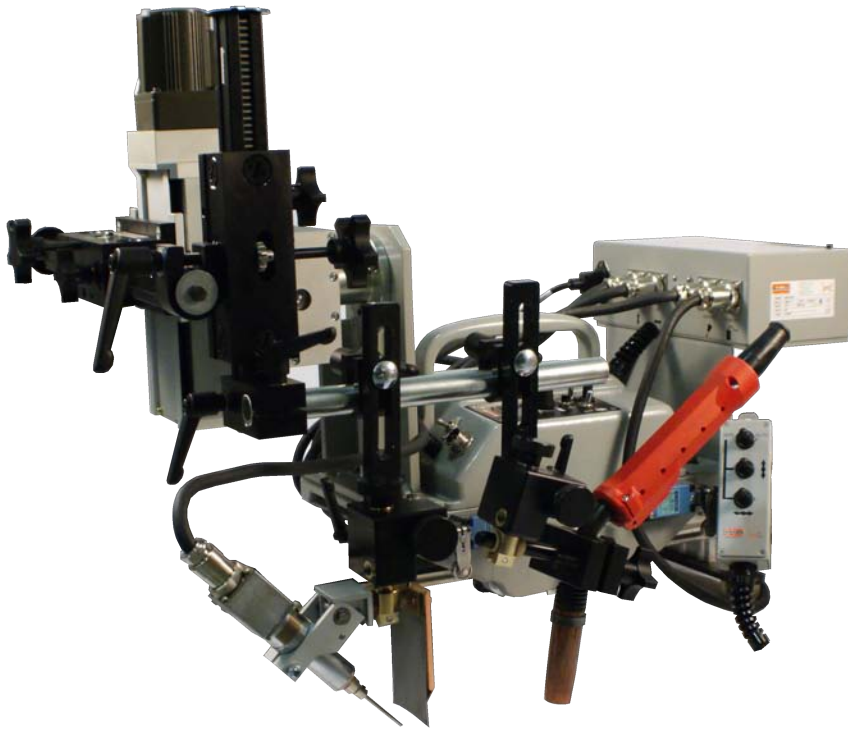

* Carriage sold separately

A high precision tracking system that maintains the torch in optimum operating position regardless of variations in the weld seam. This provides improved quality and efficiency in a wide variety of welding operations.

High Precision Weld Tracking System

MAINTAIN THE TORCH IN OPTIMUM OPERATING POSITION TO PRODUCE THE HIGHEST QUALITY WELDS



The quality and efficiency achieved with today's automated welding systems can be impaired by material warpage, misalignment, irregular edge fit-up, different material thickness and other conditions that cause variations in the weld seam. Gullco KAT® Trackers restore optimum performance when these conditions are encountered. They continually sense the slightest variation across the weld seam and automatically correct the position of the weld torch.

The trackers are designed for incorporation and use with the Gullco KAT® travel carriage system but can readily be used with other travelling and rotating devices employed in automated welding operations.

The systems are effectively employed to cut costs and increase productivity in a wide range of applications such as tank, pressure vessel, pipe and structural component fabrication and deep groove welding operations.

Gullco KAT® Trackers are available in standard or heavy duty models to meet virtually all requirements. A brief description of each is provided below.

GULLCO KAT® TRACKERS

These Trackers provide precise vertical and horizontal tracking plus...

ELECTRONIC "END OF PLATE DETECTION"

- puts the tracking system on "hold"... Preventing the torch from driving into the plate and allowing welding to continue to the plate edge.

ELECTRONIC "TACK DETECTION"

- interrupts the automatic tracking action when a tack-weld is encountered preventing the torch from rising prematurely...and returns the system to normal action when it reaches the end of the tack weld.

MODEL WSG-1200:

This model has up to 55 lb. (25kg) vertical load capacity at 4" (100mm) extension from the face plate. The standard stroke is 4" x 4" (100x100mm).

MODEL WSG-2200:

The heavy duty version of model WSG-2200 with a vertical load capacity up to 100 lbs. (45 kg) at 6" (150mm) extension from the face plate. The standard stroke is 6"x6" (150x150mm).

Note: The above data applies to standard slide assemblies. Other slide lengths, speed and higher capacities are available.



KAT® Tracker Model
WSG-1200 Electronic
Seam Tracker

KAT® Trackers are precise, dependable and highly versatile. They can be used with a wide range of Gullco accessories/ systems such as oscillators, bridge units, multiple torch assemblies etc. Contact Gullco with your requirement.



Model WSG-2200 Mounted
on a side beam carriage
equipped with a submerged
arc head

SPECIFICATIONS

GULLCO MODEL WSG-1200 KAT® TRACKER SYSTEM SYSTEM COMPONENTS

Main Control Box, Pendant Remote Control Box, Probe, Probe Micro Cross-Slide, Motorized Cross-Slide Assembly, Probe-To-Torch Mounting Bracket, Control Cables from Probe and Cross-Slide to Main Control Box, Torch Holder with vertical/ horizontal adjustment, Brackets for mounting Cross-Slide and Main Control Box on KAT® Travel Carriage.

MAIN CONTROL BOX

Incorporates main power switch, On/Off pilot light, signal lights indicating sensing function and fuse. Electronic circuit components incorporated in modular system with circuit boards for easy maintenance.

Size: (H) 5-1/2" (W) 2" (D) 1-1/2" (140 x 50 x 38mm.)

Weight: 2 lbs. (900 grams)



PENDANT REMOTE CONTROL BOX

Incorporates manual/automatic changeover switch and inching switch -vertical up/down and horizontal left/right.

Size: (H) 5-1/2" (W) 2" (D) 1-1/2" (140 x 50 x 38mm.)

Weight: 2 lbs. (900 grams)



PROBE

Supplied complete with replaceable 1/8" dia. Probe tip. The assembly incorporates a Shock Protector that protects the system's electronics by breaking when heavy shock is encountered.



PROBE MICRO CROSS SLIDE

Provides precise manual pre-positioning of probe relative to torch prior to automatic operations. Stroke plus or minus 3/4" (20mm).

Weight: 1-3/4 lbs. (900 grams)



MOTORIZED CROSS-SLIDE ASSEMBLY

Model	WSG-1200	WSG-2200
Vertical Load Capacity:	up to 55 lbs. (25kg)	up to 100 lbs
Standard Stroke Length:	4" (100mm)	6" (150mm)
Standard Stroke Speed:	10.16 in/min	9.8 in/min
Height	14" (355mm)	18 1/2" (472mm)
Width	14" (355mm)	18 1/2" (472mm)
Depth	4 3/4" (120mm)	6 1/2" (170mm)
Weight	22 lbs. (10kg)	50.6 lbs. (23kg)

Power Requirements: 110/115 Volt AC - Single phase 50/60 Hz
Longer slides, other speeds and higher capacity units available on request.

...incorporating sensing modes that cover virtual all tracking requirements

GULLCO KAT® TRACKERS MODEL WSG-1200 & 2200 SINGLE DIRECTION SENSING

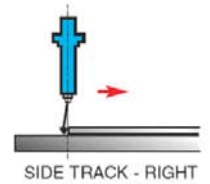
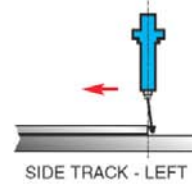

TWO DIRECTIONAL RIGHT/LEFT SENSING

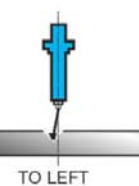
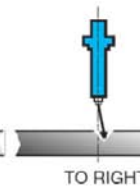
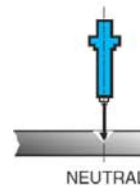

plus...

WELD TACK DETECTION

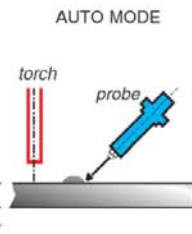
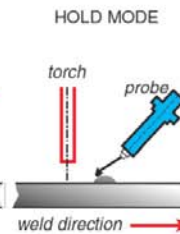
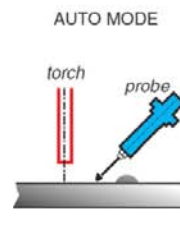

weld direction →

plus...

END OF PLATE DETECTION

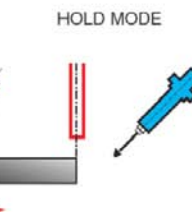
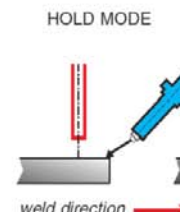
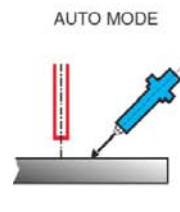

weld direction →

Gullco Mechanical Seam Trackers and Height Sensors are designed for use with the Gullco KAT® Travel Carriage to accurately maintain the required, pre-set distance between the gun or torch and the workpiece in automated welding and cutting operations.

Three models are available to effectively meet various application needs. All are constant velocity, spring-type sensors utilizing hardened and ground slide bars with recirculator ball bushings to provide 1-3/4" (44mm) of torch float.*

Model GK-190-600 Height Sensor has an adjustable swivel copper guide wheel to contact the work surface.

Model GK-190-602 Height Sensor has a stainless steel ball transfer that is particularly useful to maintain contact on curved surfaces or vertical applications.

Model GK-190-603 Seam Tracker is specifically designed for fillet welding applications.

*Other float distances available on request.

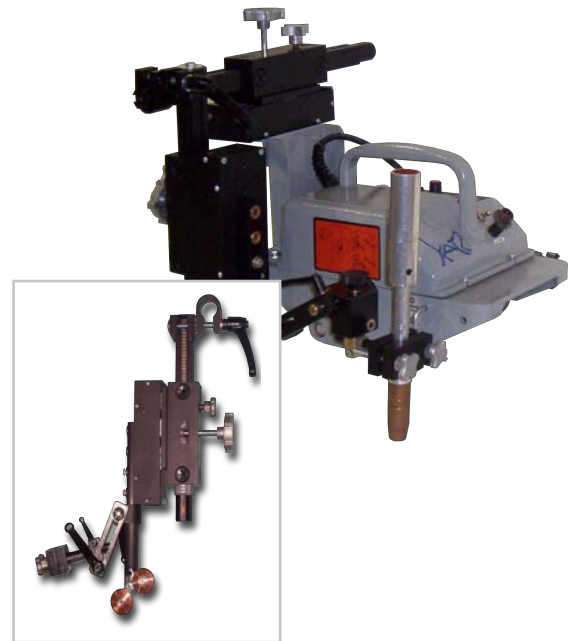

MODEL GK-190-600
Mechanical Height Sensor with constant velocity spring, hardened ground rods and circulator ball bushings to provide 1-3/4" (44mm) of torch float.

Supplied complete with adjustable, swivel copper guide wheel, 1-1/8" (29mm) sq. rack box, 12" (304mm) rack arm and swivel mounting clamp for attachment to KAT® Travel Carriage arm.

MODEL GK-190-602
Mechanical Height Sensor with constant velocity spring, hardened ground rods and circulator ball bushings to provide 1-3/4" (44mm) of torch float.

Supplied complete with hardened stainless steel ball assembly, 1-1/8" (29mm) sq. rack box, 12" (304mm) rack arm and swivel mounting clamp for attachment to KAT® Travel Carriage arm.

MODEL GK-190-603
Mechanical Seam Tracker with constant velocity spring, hardened ground rods and recirculator ball bushings to provide 1-3/4" (44mm) of 45° torch float and 1-1/4" (31.75mm) of weld seam misalignment in both the horizontal and vertical plane. The assembly includes a Micro Cross-slide with gun holder to provide 3/4" (19mm) of XY adjustment. Supplied as standard with single copper guide wheel, 1- 1/8" (29mm) sq. rack box, 12" (304mm) rack arm and 1-1/8" (29mm) swivel mounting clamp for attachment to KAT® Carriage rack arm.

(A) When the weld seam is below the Kat carriage level, the sensor rack arm clamp is located below the sensor rack box.

(B) When the weld seam is above carriage level the sensor rack arm clamp is positioned above the sensor rack box. Additional height adjustment may be required. We recommend the use of our Rack Box Riser Assembly (below) to increase the carriage rack arm height by 2", 4" or 6"

SPECIAL SENSOR GUIDE WHEEL ASSEMBLIES
For Fillet Welding applications involving tack welds

Model GK-190-604
Dual in-line guide wheels react independently when tack welds encountered on thin edge material, one always in contact with the weld seam.

Model GK-190-605
Dual, side-by-side guide Wheels straddle tack weld Line in general range of Fillet Weld applications.

KAT, KBM, MOGGY, KATBAK & SAM are registered trademarks of Gullco Enterprises Limited

SPECIFICATIONS ARE SUBJECT TO CHANGE WITHOUT NOTICE. ALL DIMENSIONS ARE NOMINAL

Distributed by:

GULLCO

CANADA - GULLCO INTERNATIONAL LIMITED
Phone: 905-953-4140 Fax: 905-953-4138 e-mail: sales@gullco.com

U.S.A - GULLCO INTERNATIONAL INC.
Phone: 440-439-8333 Fax: 440-439-3634 e-mail: ussales@gullco.com

EUROPE - GULLCO INTERNATIONAL (U.K.) LIMITED
Phone: +44 1257-253579 Fax: +44 1257-254629 e-mail: uksales@gullco.com

AUSTRALIA - GULLCO INTERNATIONAL PTY LIMITED
Phone: 61 (0)7 3348 5515 Fax: 61 (0)7 3348 5510 e-mail: ausales@gullco.com

INDIA - GULLCO INTERNATIONAL INDIA PVT LIMITED
Phone: 91-20-6526-0382 Fax: 91-20-2683-6656 e-mail: indsales@gullco.com

CHINA - GULLCO INTERNATIONAL SHANGHAI LIMITED
Phone: +8621-50460341 Fax: +8621-50463554 e-mail: c.zhang@gullco.com

SINGAPORE - GULLCO INTERNATIONAL LIMITED
Phone: +65-9385-4468 e-mail: benny.lim@gullco.com

LATIN AMERICA - GULLCO INTERNATIONAL LIMITED
Phone: 55-11-99485-1336 e-mail: rogerio.macedo@gullco.com

Stuch GmbH & Co. KG Schweisstechnik - GERMANY
Phone: (02 03) 72 94 95 Fax: (02 03) 72 94 96 e-mail: info@stuch-schweisstechnik.de

ELECTRONIC ARC HEIGHT SENSOR - E.A.H.S



Lightweight and durable components to reduce operator fatigue.

The 4" (10.16 cm) standard slide features engraved top, bottom and center marks for quick slide position reference to aid setup.

Standard 25 ft. (762 cm) of remote pendant control cable means the current sensor main control box can be kept away from the work area reducing trip hazards; an additional 25 ft. (762 cm) extension is available.

Easy setup and torch calibration.

Sensor control box design allows the operator to use their standard existing welding cables.

Extremely accurate arc detection
Slide travel speed factory set at 10 IPM
(25.4 cm/ min), programmable range of 3 IPM
(7.6 cm/min) to 17 IPM (43.2 cm/min)

Easy to use remote pendant interface with coarse and fine slide adjustment.

High Precision Torch Height Adjustment Through Current Detection

ACCURATE ARC DETECTION AND PRECISION CONTROL OVER THE TORCH HEIGHT



E.A.H.S SYSTEM COMPONENTS

The Electronic Arc Height Sensor (E.A.H.S.) from Gullco is an automated welding system used throughout the world to automate and improve the quality and efficiency of the weld produced in automatic mechanized welding operation. This is achieved through minimizing weld defects such as poor penetration, incomplete fusion, overlap and undercut. Also, detrimental factors such as poor or awkward accessibility, operator fatigue, or inconsistent workmanship are eliminated. Required quality levels are consistently attained and productivity and profitability increased.

400 AMP GK-203-400



800 AMP GK-203-800

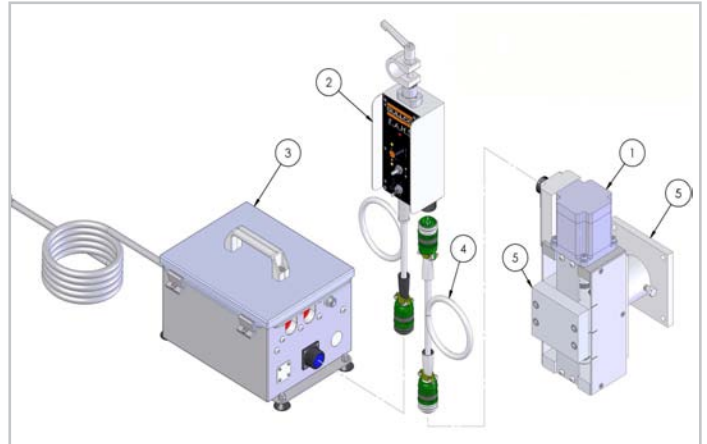

ITEM	PART NO.	DESCRIPTION	QTY.
1	GK-203-001	Slide Assembly	1
2	GK-203-002	E.A.H.S Remote Pendant	1
3	GK-203-003-A	Control Box Assembly 42V Input	1
	GK-203-003-B	Control Box Assembly 115V Input	1
	GK-203-003-C	Control Box Assembly 230V Input	1
4	GK-201-125	Head Cable Assembly	1
5	GC-058	Mounting Hardware	1
6	GK-201-112	Gun Holder Assembly	1

ITEM	PART NO.	DESCRIPTION	QTY.
1	GK-203-007	Heavy Slide Assembly	1
2	GK-203-002	E.A.H.S Remote Pendant	1
3	GK-203-014-A	800 AMP Control Box Assembly 42V Input	1
	GK-203-014-B	800 AMP Control Box Assembly 115V Input	1
	GK-203-014-C	800 AMP Control Box Assembly 230V Input	1
4	GK-201-125	Head Cable Assembly	1
5	GK-203-093	HD Slide Mounting Hardware	1

VERTICAL SLIDE CAPACITY*

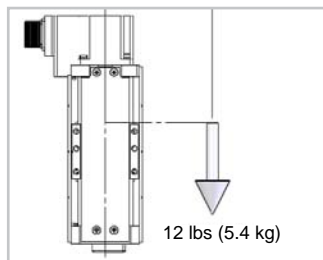

HORIZONTAL SLIDE CAPACITY*

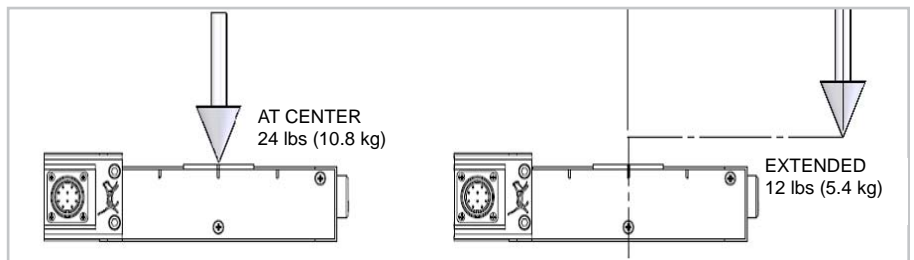

* For other configuration capacities, please consult your Gullco sales representative or request info at www.gullco.com

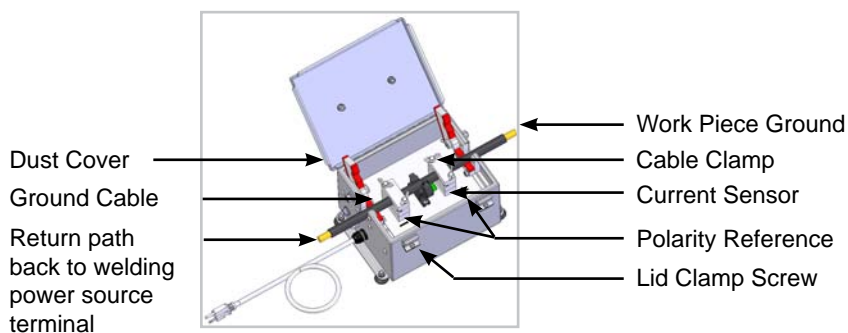

E.A.H.S REMOTE PENDANT CONTROL

A highly sophisticated, yet easy to use, microprocessor based control drives a high torque, high resolution, low vibration stepper motor located in the linear slide, allowing the height of the welding gun to be precisely controlled. The control interfaces with the linear slide through a removable head cable assembly and with the main control box through a fixed pendant control cable. Controlling the height of the welding torch will allow the quality and appearance of the weld to be perfected.

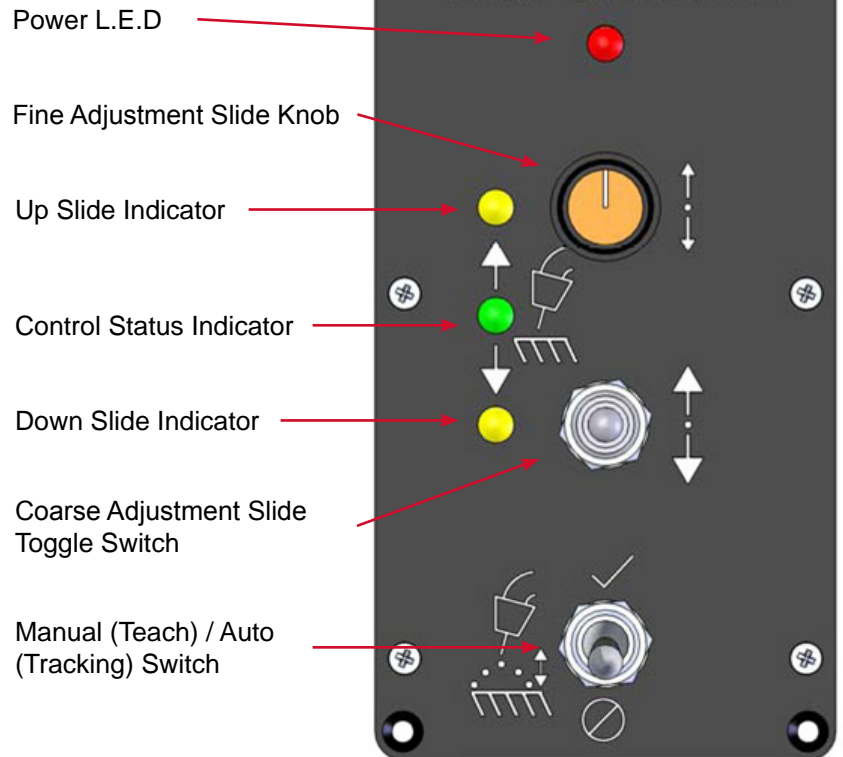

E.A.H.S UNIT ACCESSORIES

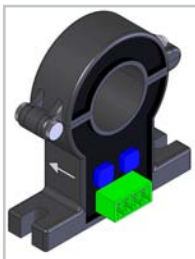

GK-203-070: 500 AMP CURRENT SENSOR

This sensor increases the current sensing range up to 97% of 500 AMPS (485 AMPS). It is a direct replacement for the existing 400 AMP sensor

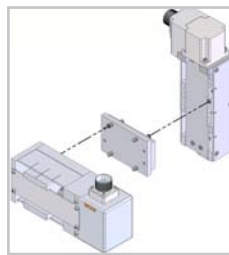

GK-203-086 : LINEAR OSCILLATOR TO E.A.H.S SLIDE ADAPTER

This adapter kit allows the Gullco Linear Oscillator (**GK-201-120**) to be mounted to the E.A.H.S slide (**GK-203-001**). Slides not included.



GK-203-092: REMOTE PENDANT EXTENSION 25 FT (762 cm)

This 25 ft. (762 cm) extension will increase the total length of control cable between the control box and the remote pendant to 50 ft. (1.52 m)

SPECIFICATIONS

1. GK-203-003: Control Box with 25 ft. (9 m) control cable and 9 ft. (3 m) power cord
2. GK-203-001: Motorized Vertical Correction Slide
3. GK-203-002: Remote Control Pendant with 25 ft. (7.62 m) control cable
4. GK-203-003: Control Box Assembly (A- 42V, B-115V, C-230V)
5. GK-201-125: Motorized Vertical Correction Slide Control Cable - 6 ft. (1.8 m)
6. GC-058: Mounting Hardware
7. GK-201-112: Gun Holder Assembly



The E.A.H.S. works by measuring welding current, comparing it to a target value that has been taught by the operator and automatically adjusting the height of the welding gun to maintain the target welding current.

The Model GK-203-400 is a standalone unit meaning it does not interface with the wire feeder. The arc activation trigger signal of the welding equipment that is used to start/stop the welding process must come from a separate piece of equipment, i.e. customer supplied control or other Gullco equipment. This advanced Electric Arc Height Sensor package uses Gullco's sophisticated, yet easy to use, E.A.H.S. remote pendant control, in conjunction with a 4" linear slide assembly and current sensing control box, to provide precision arc height control during the welding process.

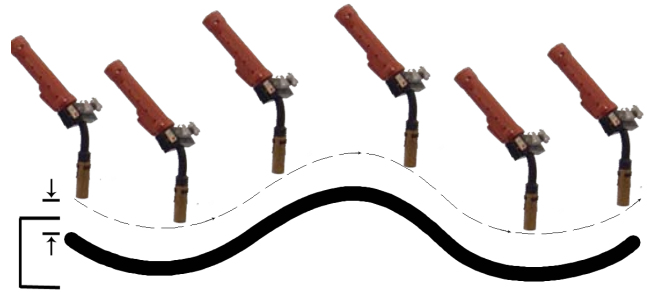

Welding guns are readily mounted on the linear slide. This equipment is intended to automatically control the torch height throughout the welding process. The longitudinal movement can be obtained from either the work piece traveling while the linear remains stationary, or, by a travel carriage such as the Gullco KAT® carriage carrying the E.A.H.S. equipment down the length of the work piece, which is the norm. Combining the welding gun height control with the precision controlled travel speed of the KAT® carriage will ensure high quality workmanship can be produced.



KAT, KBM, MOGGY, KATBAK & SAM are registered trademarks of Gullco Enterprises Limited

Distributed by:

SPECIFICATIONS ARE SUBJECT TO CHANGE WITHOUT NOTICE. ALL DIMENSIONS ARE NOMINAL

GULLCO		
CANADA - GULLCO INTERNATIONAL LIMITED		
Phone: 905-953-4140	Fax: 905-953-4138	e-mail: sales@gullco.com
U.S.A - GULLCO INTERNATIONAL INC.		
Phone: 440-439-8333	Fax: 440-439-3634	e-mail: ussales@gullco.com
EUROPE - GULLCO INTERNATIONAL (U.K.) LIMITED		
Phone: +44 1257-253579	Fax: +44 1257-254629	e-mail: uksales@gullco.com
AUSTRALIA - GULLCO INTERNATIONAL PTY LIMITED		
Phone: 61 (0)7 3348 5515	Fax: 61 (0)7 3348 5510	e-mail: ausales@gullco.com
INDIA - GULLCO INTERNATIONAL INDIA PVT LIMITED		
Phone: 91-20-6526-0382	Fax: 91-20-2683-6656	e-mail: indsales@gullco.com
CHINA - GULLCO INTERNATIONAL SHANGHAI LIMITED		
Phone: +8621-50460341	Fax: +8621-50463554	e-mail: c.zhang@gullco.com
SINGAPORE - GULLCO INTERNATIONAL LIMITED		
Phone: +65-9385-4468		e-mail: benny.lim@gullco.com
LATIN AMERICA - GULLCO INTERNATIONAL LIMITED		
Phone: 55-11-99485-1336		e-mail: rogerio.macedo@gullco.com
Stuch GmbH & Co. KG Schweisstechnik - GERMANY		
Phone: (02 03) 72 94 95	Fax: (02 03) 72 94 96	e-mail: info@stuch-schweisstechnik.de



GULLCO



PRODUCT CASE STUDY FILE

Innovative Mining and Engineering Solutions Pty Ltd. (IMES)

Solutions for problems with abrasion or high wear

THE PARAMETERS

- Arc Voltage: 28 Volts
- Amperage: 150 amps
- Torch Angle: 90°
- Oscillation: Linear (20mm width)

THE PROJECT

The Queensland company IMES has begun using a Plasma Transfer Arc Welding (PTAW) process in the repair of their mining equipment. Through the use of Gullco International Pty Limited's KAT® Welding Travel Carriage and Electronic Arc Height Sensor (EAHS) combination IMES was able to increase production while reducing the overall cost.

The precise control over the welding parameters helped maintain the job integrity and welding processes. Specifically the critical "arc current" was precisely maintained through the use of the EAHS System which automatically adjusts the torch height to maintain current levels.

THE CHALLENGE

IMES was faced with the problem of high wear and abrasion on critical steel mining equipment. A solution was needed when pressures to reduce costs where met with the need to maintain high quality welds and welding processes. Gullco's technical sales team assessed the application and where able to supply the equipment necessary to overcome this problem and meet the requirements of the welding engineers on site. It was important that the equipment supplied for the completion of the application be versatile enough to work with existing welding power sources and equipment.

THE SOLUTION

The use of the KAT® Welding Travel Carriage and Electronic Arc Height Sensor (EAHS) in combination with the PTAW welding process solved the problem of reducing over all cost without sacrificing weld integrity. The Gullco welding automation equipment supplied leaves a smooth surface which does not reduce the flow of material.

The automation process involved little heat transfer and as a result, very little change in the physical properties of the parent material. The plasma arc transfer process in partner with the welding automation from Gullco tripled the life of the steel mining equipment.



KAT, MOGGY, KATBAK, & SAM are registered trademarks of Gullco Enterprises Limited

SPECIFICATIONS ARE SUBJECT TO CHANGE WITHOUT NOTICE

Distributed by:

GULLCO

CANADA - GULLCO INTERNATIONAL LIMITED

Phone: 905-953-4140 Fax: 905-953-4138 e-mail: sales@gullco.com

U.S.A - GULLCO INTERNATIONAL INC.

Phone: 440-439-8333 Fax: 440-439-3634 e-mail: ussales@gullco.com

EUROPE - GULLCO INTERNATIONAL (U.K.) LIMITED

Phone: +44 1257-253579 Fax: +44 1257-254629 e-mail: uksales@gullco.com

AUSTRALIA - GULLCO INTERNATIONAL PTY LIMITED

Phone: 61 (0)7 3348 5515 Fax: 61 (0)7 3348 5510 e-mail: ausales@gullco.com

INDIA - GULLCO INTERNATIONAL INDIA PVT LIMITED

Phone: 91-20-6526-0382 Fax: 91-20-2683-6656 e-mail: indsales@gullco.com

CHINA - GULLCO INTERNATIONAL SHANGHAI LIMITED

Phone: +8621-50460341 Fax: +8621-50463554 e-mail: c.zhang@gullco.com

SINGAPORE - GULLCO INTERNATIONAL LIMITED

Phone: +65-9385-4468 e-mail: benny.lim@gullco.com

LATIN AMERICA - GULLCO INTERNATIONAL LIMITED

Phone: 55-11-99485-1336 e-mail: rogerio.macedo@gullco.com

Stuch GmbH & Co. KG Schweisstechnik - GERMANY

Phone: (02 03) 72 94 95 Fax: (02 03) 72 94 96 e-mail: info@stuch-schweisstechnik.de

WWW.GULLCO.COM

CS-IMES-10-01

TRACKLESS WELDING CARRIAGE - MOGGY®



Ideal for automatic horizontal fillet, lap or butt welding applications

Controls available for continuous or stitch welding operations

Dual gun holder assemblies make automated simultaneous welding efficient

MOGGY® wheels can be inverted to allow carriage to operate on v-groove track

The MOGGY® can be equipped with a variety of accessories including: weld oscillator, cutting torch attachment and internal radius guide wheels

GM-03-050 - CONTINUOUS WELD

GM-03-100 - STITCH WELD



Automate Fillet, Lap, and Butt Welds with Precision

VERSITILE TRACKLESS AUTOMATION CARRIAGE FOR A VARIETY OF APPLICATONS



TRACKLESS AUTOMATION WELDING CARRIAGE



The MOGGY® is intended to automate and improve the quality of welding and cutting operations by carrying the welding gun(s) or cutting torch(es), at precisely controlled speeds, along the path of the joint. The MOGGY® carriage also provided interface between the welding and cutting motion and the arc start and stop signals. The automation carriage is normally guided by adjustable guide wheels which are set to always drive the carriage slightly into the vertical member (usually either the vertical member of a fillet joint or a template/fence placed parallel to the joint). Industry standard 6" v-groove track may also be used to guide the parth of the MOGGY®. The carriage is flexible enough to allow it to be easily configured for horizontal lap, butt and fillet weld joints as well as a variety of cutting processes.

Using the MOGGY® automation carriage system will add accuracy and uniformity to welding and cutting applications while increasing productivity. Typical applications include shipbuilding, offshore construction, steel fabrication, etc.

Standard MODEL GM-03-050 MOGGY® Carriage with control for continuous travel, and with forward/stop/reverse switch, wire feed start on/ off switch, travel speed potentiometer, auto wire feed start with delay carriage start, travel speed displayed in LED window, wire feed connector with 15 ft. (4572mm) control cable.

Standard MODEL GM-03-100 MOGGY® Carriage with control for continuous or stitch welding, and with a control that uses a Gullco microprocessor to provide accurate repeatability regardless of travel speeds for weld distance on and weld distance off. It has a forward/stop/reverse switch, wire feed start on/off switch, travel speed potentiometer, auto wire feed start with delay carriage start, wire feed connector with 15 ft. (4572mm) control cable. All functions displayed in an LED window.

FILLET JOINT WELDING



The MOGGY® performing a fillet weld using a template, guide or fence positioned parallel to the workpiece. The actual workpiece is often used as the guide.

LAP JOINT WELDING



The MOGGY® is performing a lap joint weld. It is guided by Industry Standard 6" (152.4mm) v-groove track running parallel to the joint.

Precise Torch Alignment To The Seam

Adjustable guide rolls mounted on the front or back of the carriage monitor the slightest seam variations following straight or curved surfaces...maintaining optimum torch positioning as the carriage travels.

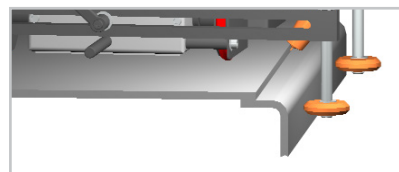
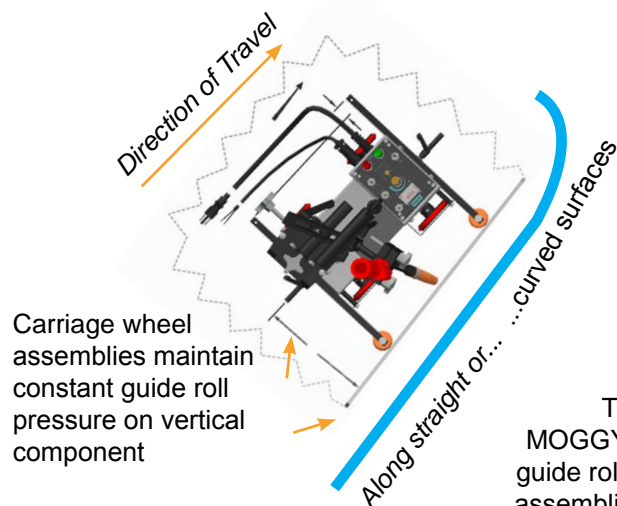

The MOGGY® guide roller assemblies can be configured in a variety of ways enabling extreme versatility.

BUTT JOINT WELDING

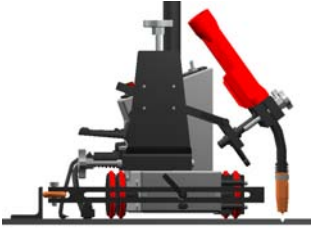

The MGGY® is ideal for butt joint welding. Here the MGGY® is using a fence to guide it accurately along the desired path. Standard v- groove track can also be used.

DUAL GUN WELDING

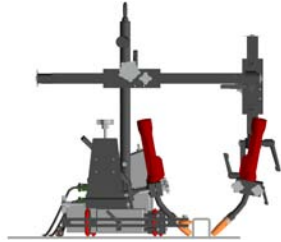

Dual gun holder assembly mounted on the MGGY® enables positioning of two guns and simultaneous activation of two wire feed signals. MGGY® is guided by the workpiece.

JOINT TRACKING

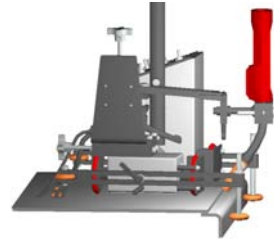

Adjustable height guide roller assemblies are available to track joints with a vertical member higher or lower than the set height of guide roller wheels.

RADIAL OSCILLATOR

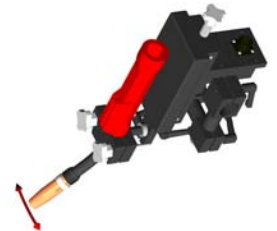

Replaces the standard gun holder assembly in order to weave the gun across the joint while the MGGY® provides the weld travel motion.

CARRIAGE CONTROL LAYOUT

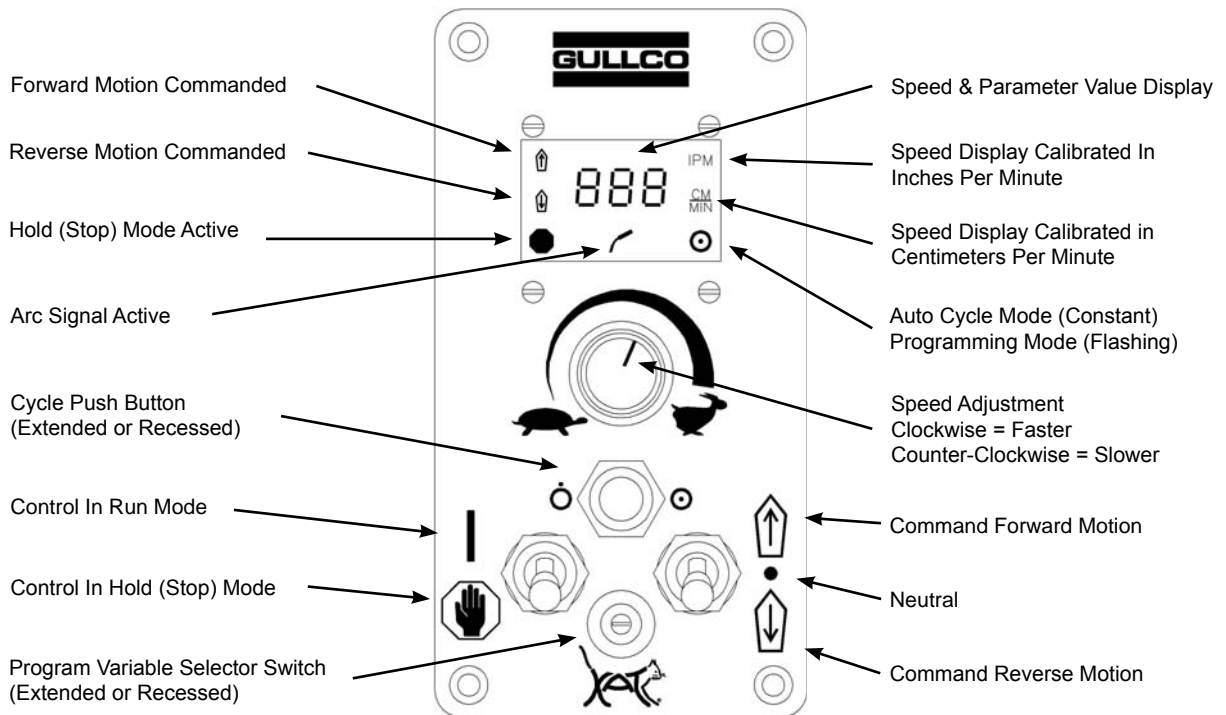

Accessories available:

GK-194-O-330 - Radial Oscillator complete with bracketry for mounting on Gullco MGGY® Carriage.

GM-03-059 - Adjustable Guide Roller Assembly enables joint tracking where the vertical member is lower/higher than set height of guide roller wheels.

GM-01-065 - Cutting Torch Holder Assembly enables automated torch cutting operations.

GM-01-070 - Dual Gun Holder Assembly enables the use of two independently positioned welding guns with two wire feed signals simultaneously activated.

Also available as a SUBMERGED ARC MGGY®

For more information on the submerged arc welding carriage and other products visit.

www.gullco.com



SPECIFICATIONS

Speed Range: 5.8 - 115.178 in/min (14.6 - 292.552 cm/min). *Special speed range of 3 - 54 in/min (7.6 - 137 cm/min) is also available as a special request.

Maximum Incline: 30°

Gun Positioning Slides: 1-3/4" (44.5 mm)
Vertical and Horizontal Stroke

Weight of MOGGY®: 31 lbs. (14.1 kg)
complete with all attachments (single gun model)

Supply Voltage: Either 42, 115, or 230 VAC,
single phase, 50/60 Hz., 30 watts

Drive Motor:
24 VDC permanent magnet gear motor

Drive Wheel Temp Range:
-65°F to 450°F (-54°C to 232°C)

Complies with: C.S.A. & N.R.T.L.
(file #LR35006-8) & C.E. Certification.



CARRIAGE DIMENSIONS

	IMPERIAL	METRIC
A	25.00"	635.0 mm
B	9.57"	243.1 mm
C	7.25"	184.2 mm
D	14.01"	355.7 mm
E	Min 1.44" Max 7.06"	Min 3.6 mm Max 179.3 mm
F	11.50"	292.1 mm
G	17.00"	431.8 mm

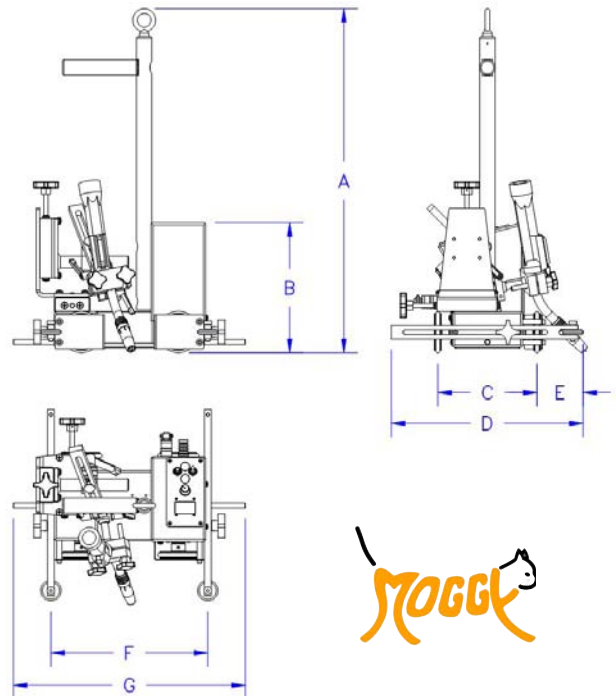

KAT, KBM, MOGGY, KATBAK & SAM are registered trademarks of Gullco Enterprises Limited

Distributed by:

SPECIFICATIONS ARE SUBJECT TO CHANGE WITHOUT NOTICE. ALL DIMENSIONS ARE NOMINAL

GULLCO		
CANADA - GULLCO INTERNATIONAL LIMITED		
Phone: 905-953-4140	Fax: 905-953-4138	e-mail: sales@gullco.com
U.S.A - GULLCO INTERNATIONAL INC.		
Phone: 440-439-8333	Fax: 440-439-3634	e-mail: ussales@gullco.com
EUROPE - GULLCO INTERNATIONAL (U.K.) LIMITED		
Phone: +44 1257-253579	Fax: +44 1257-254629	e-mail: uksales@gullco.com
AUSTRALIA - GULLCO INTERNATIONAL PTY LIMITED		
Phone: 61 (0)7 3348 5515	Fax: 61 (0)7 3348 5510	e-mail: ausales@gullco.com
INDIA - GULLCO INTERNATIONAL INDIA PVT LIMITED		
Phone: 91-20-6526-0382	Fax: 91-20-2683-6656	e-mail: indsales@gullco.com
CHINA - GULLCO INTERNATIONAL SHANGHAI LIMITED		
Phone: +8621-50460341	Fax: +8621-50463554	e-mail: c.zhang@gullco.com
SINGAPORE - GULLCO INTERNATIONAL LIMITED		
Phone: +65-9385-4468		e-mail: benny.lim@gullco.com
LATIN AMERICA - GULLCO INTERNATIONAL LIMITED		
Phone: 55-11-99485-1336		e-mail: rogerio.macedo@gullco.com
Stuch GmbH & Co. KG Schweisstechnik - GERMANY		
Phone: (02 03) 72 94 95	Fax: (02 03) 72 94 96	e-mail: info@stuch-schweisstechnik.de

TRACKLESS WELDING CARRIAGE - MAGNETIC MOGGY®



Magnetic base allows for out of position welding applications

Ideal for automatic horizontal fillet, lap or butt welding applications

Controls available for continuous or stitch welding operations

Dual gun holder assemblies make automated simultaneous welding efficient

The MOGGY® can be equipped with a variety of accessories including: weld oscillator, cutting torch attachment and internal radius guide wheels

GM-03-300 - CONTINUOUS WELDING

GM-03-350 - STITCH WELDING



Automate Fillet, Lap, and Butt Welds with Precision

VERSITILE TRACKLESS AUTOMATION CARRIAGE FOR A VARIETY OF APPLICATONS



TRACKLESS AUTOMATION WELDING CARRIAGE



The Magnetic MOGGY® is intended to automate and improve the quality of welding and cutting operations by carrying the welding gun or cutting torch, at precisely controlled speeds, along the path of the joint as well as providing the interface between the welding and cutting motion and the arc start and stop signal. The Magnetic MOGGY® is normally guided by adjustable guide wheels which are used to keep a set distance from the joint path.

The carriage is flexible enough to allow it to be easily configured for horizontal lap, butt and fillet weld joints as well as a variety of cutting processes. The GM-03-350 model provides continuous mode welding and cutting and the GM-03-300 models also offer accurate distance stitch weld functionality, regardless of travel speed adjustment. Using the Magnetic MOGGY® automation carriage system will add accuracy and uniformity to welding and cutting operations while increasing productivity. Typical applications include shipbuilding, offshore construction, steel fabrication industries, etc.

Continuous Welding MODEL GM-03-350

Magnetic MOGGY® Carriage with control for continuous travel, and with forward/stop/reverse switch, wire feed start on/ off switch, travel speed potentiometer, auto wire feed start with delay carriage start, travel speed displayed in LED window, wire feed connector with 15 ft. (4572mm) control cable.

Stitch Welding MODEL GM- 03-300

Magnetic MOGGY® Carriage with control for continuous or stitch welding, and with a control that uses a Gullco microprocessor to provide accurate repeatability regardless of travel speeds for weld distance on and weld distance off. It has a forward/stop/reverse switch, wire feed start on/off switch, travel speed potentiometer, auto wire feed start with delay carriage start, wire feed connector with 15 ft. (4572mm) control cable. All functions displayed in an LED window.

FILLET JOINT WELDING



The MOGGY® performing a fillet weld using a template, guide or fence positioned parallel to the workpiece. The actual workpiece is often used as the guide.

BUTT JOINT WELDING

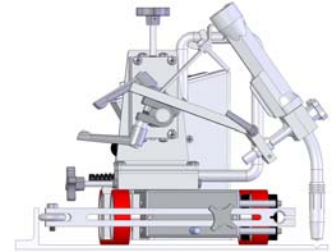

The MOGGY® is ideal for butt joint welding. Here the MOGGY® is using a fence to guide it accurately along the desired path. Standard v- groove track can also be used.

Precise Torch Alignment To The Seam

Adjustable guide rolls mounted on the front or back of the carriage monitor the slightest seam variations following straight or curved surfaces...maintaining optimum torch positioning as the carriage travels.

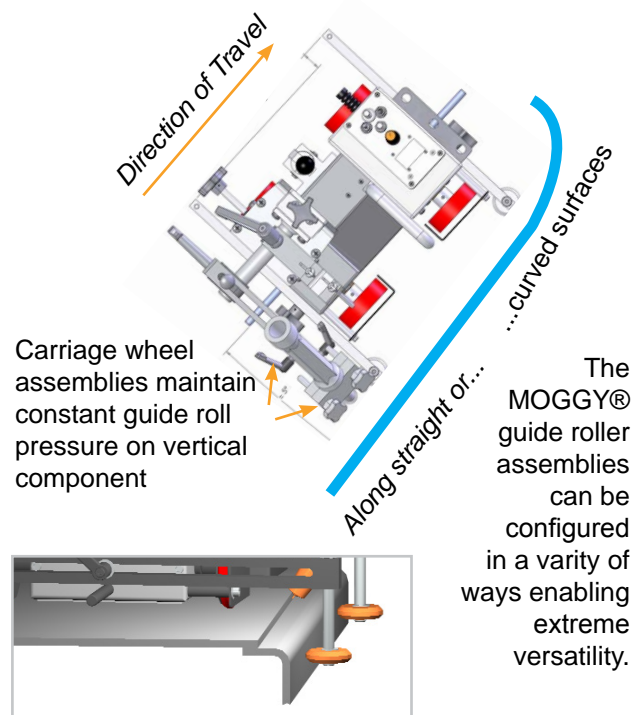

LAP JOINT WELDING



The MOGGY® is performing a lap joint weld. It is guided by Industry Standard 6" (152.4mm) v-groove track running parallel to the joint.

DUAL GUN WELDING

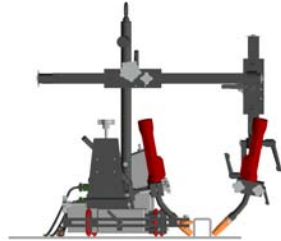

Dual gun holder assembly mounted on the MOGGY® enables positioning of two guns and simultaneous activation of two wire feed signals. MOGGY® is guided by the workpiece.

JOINT TRACKING

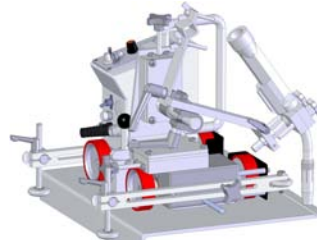

Adjustable height guide roller assemblies are available to track joints with a vertical member higher or lower than the set height of guide roller wheels.

RADIAL OSCILLATOR



Replaces the standard gun holder assembly in order to weave the gun across the joint while the MOGGY® provides the weld travel motion.

CARRIAGE CONTROL LAYOUT

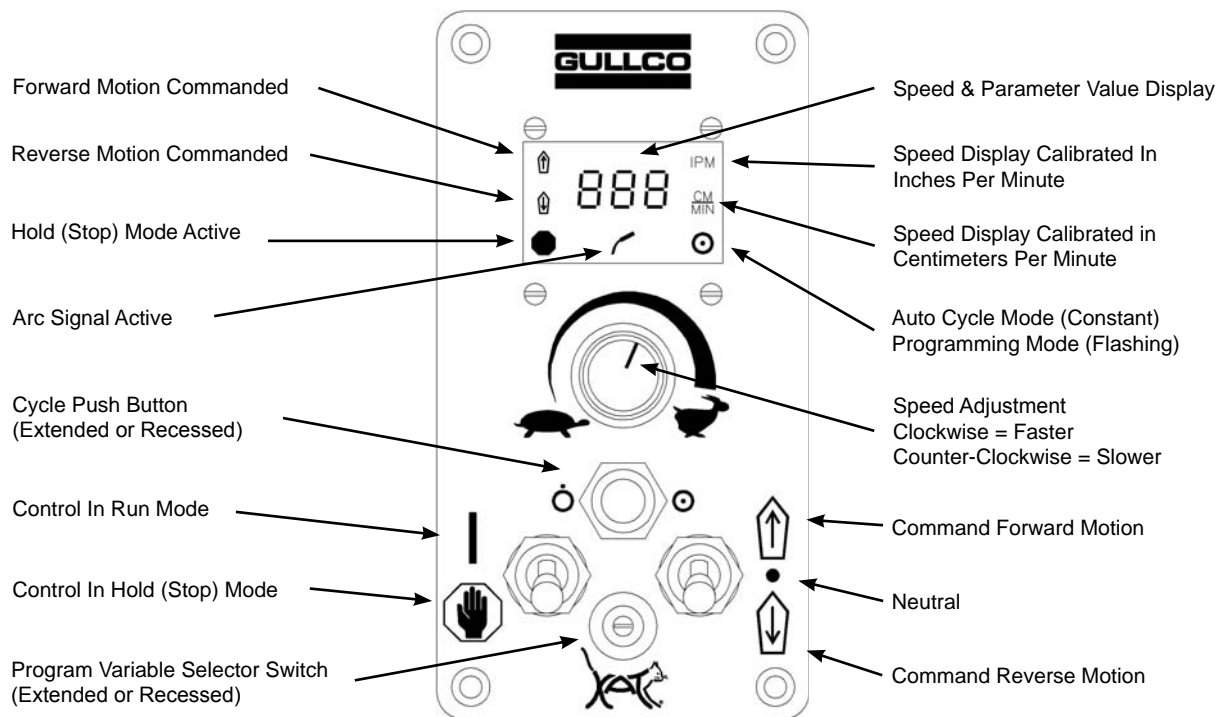

Accessories available:

GK-194-O-330 - Radial Oscillator complete with bracketry for mounting on Gullco MOGGY® Carriage.

GM-03-059 - Adjustable Guide Roller Assembly enables joint tracking where the vertical member is lower/higher than set height of guide roller wheels.

GM-01-065 - Cutting Torch Holder Assembly enables automated torch cutting operations.

GM-01-070 - Dual Gun Holder Assembly enables the use of two independently positioned welding guns with two wire feed signals simultaneously activated.

Also available as a SUBMERGED ARC MOGGY®

For more information on the submerged arc welding carriage and other products visit.

www.gullco.com



SPECIFICATIONS

Speed Range: 3 - 54 in/min (7.6 - 137 cm/min)

Gun Positioning Slides: 1-3/4" (44.5 mm)
Vertical and Horizontal Stroke

Weight of MOGGY®: 31 lbs. (14.1 kg)
complete with all attachments (single gun model)

Supply Voltage: Either 42, 115, or 230 VAC,
single phase, 50/60 Hz., 30 watts

Drive Motor:
24 VDC permanent magnet gear motor

Drive Wheel Temp Range:
-40°F to 180°F (-40°C to 82°C)

Complies with: C.S.A. & N.R.T.L.
(file #LR35006-8) & C.E. Certification.



CARRIAGE DIMENSIONS

	IMPERIAL	METRIC
A	12.90"	327.3 mm
B	9.50"	241.3 mm
C	8.45"	214.6 mm
D	14.01"	355.7 mm
E	Min 1.95" Max 5.46"	Min 4.93 mm Max 138.7 mm
F	11.50"	292.1 mm
G	17.00"	431.8 mm

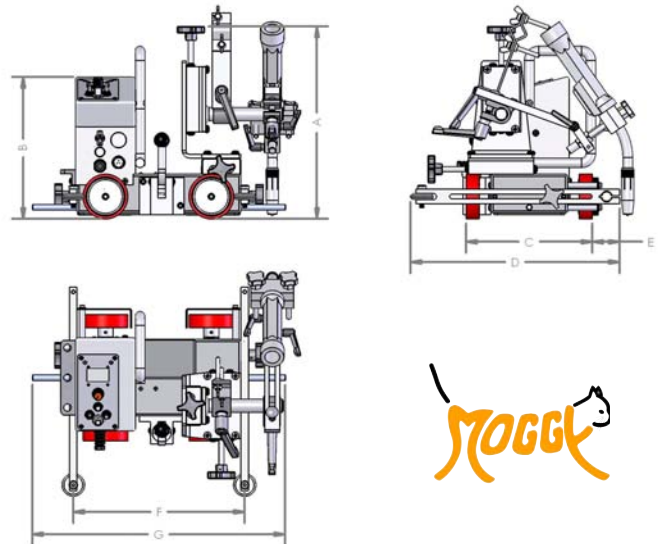

KAT, KBM, MOGGY, KATBAK & SAM are registered trademarks of Gullco Enterprises Limited

SPECIFICATIONS ARE SUBJECT TO CHANGE WITHOUT NOTICE. ALL DIMENSIONS ARE NOMINAL

Distributed by:

WWW.GULLCO.COM

MAG-13-01

GULLCO		
CANADA - GULLCO INTERNATIONAL LIMITED		
Phone: 905-953-4140	Fax: 905-953-4138	e-mail: sales@gullco.com
U.S.A - GULLCO INTERNATIONAL INC.		
Phone: 440-439-8333	Fax: 440-439-3634	e-mail: ussales@gullco.com
EUROPE - GULLCO INTERNATIONAL (U.K.) LIMITED		
Phone: +44 1257-253579	Fax: +44 1257-254629	e-mail: uksales@gullco.com
AUSTRALIA - GULLCO INTERNATIONAL PTY LIMITED		
Phone: 61 (0)7 3348 5515	Fax: 61 (0)7 3348 5510	e-mail: ausales@gullco.com
INDIA - GULLCO INTERNATIONAL INDIA PVT LIMITED		
Phone: 91-20-6526-0382	Fax: 91-20-2683-6656	e-mail: indsales@gullco.com
CHINA - GULLCO INTERNATIONAL SHANGHAI LIMITED		
Phone: +8621-50460341	Fax: +8621-50463554	e-mail: c.zhang@gullco.com
SINGAPORE - GULLCO INTERNATIONAL LIMITED		
Phone: +65-9385-4468		e-mail: benny.lim@gullco.com
LATIN AMERICA - GULLCO INTERNATIONAL LIMITED		
Phone: 55-11-99485-1336		e-mail: rogerio.macedo@gullco.com
Stuch GmbH & Co. KG Schweisstechnik - GERMANY		
Phone: (02 03) 72 94 95	Fax: (02 03) 72 94 96	e-mail: info@stuch-schweisstechnik.de

SUBMERGED ARC WELDING CARRIAGE - SAM®



The versatility and reliability of the Gullco MOGGY® trackless travel carriage system and a variety of quality engineered components combine to provide a highly flexible self-contained welding unit. This SAM® unit is designed to produce precision, quality Submerged Arc or MIG welds.

The SAM® Carriage, friction drive heavy-duty welding carriage, with positive chain drive on four (4) rubber tired wheels using a closed loop tack feedback for accurate speed control. The carriage controlled by the Gullco low voltage 24 volt GSP microprocessor pulse width modulation motor control, all mounted in a remote pendant control box attached to 8 ft. (243.84 cm) control cable housing the GSP control providing the forward/stop/reverse switch and infinitely variable 4-turn speed potentiometer. LED display in IPM or cm/min. An interface cable assembly allows the Miller HDC 1500 DX to control the run/stop function of the SAM® Carriage. A manual clutch enables free wheeling. The carriage comes complete with a main mounting mast and handle assembly, mounting arm for one wire reel. All the mounting arms are equipped with quick jaw mast clamp assembly; vertical and horizontal manual 4" x 4" slides (with hardened ground rods with sleeve bearings for ease of adjustment). Control support arm and one (1) set (two[2]) adjustable guide roll arms. For operation on either 42/115/230 volts, single phase, 50/60 Hz AC power supply. Specify voltage when placing order - B = 115 V, C = 230 V.

SAM® Carriage comes in a model for mounting customer's supplied single sub-arc package. Carriage specifications same as Model **GM-02-295**. No welding equipment is supplied.

Automate Submerged Arc Welding Applications

HEAVY DUTY SAM® TRACKLESS WELDING CARRIAGE FOR SUBMERGED ARC AND MIG WELDING

WELDING AND CUTTING

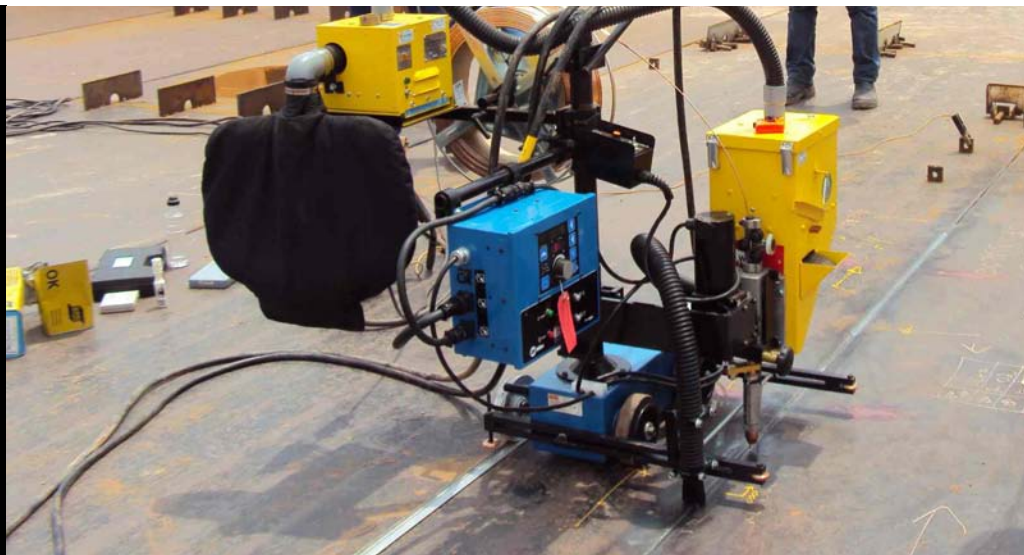

SPECIFICATIONS

GM-02-250 SAM® Heavy-Duty Friction Drive Carriage

The carriage specifications are the same as that of the GM-02-295, but provided with 17" x 22" (43.18 x 55.89 cm) aluminum plate providing full flat mounting surface for customer's supplied wire feeder.

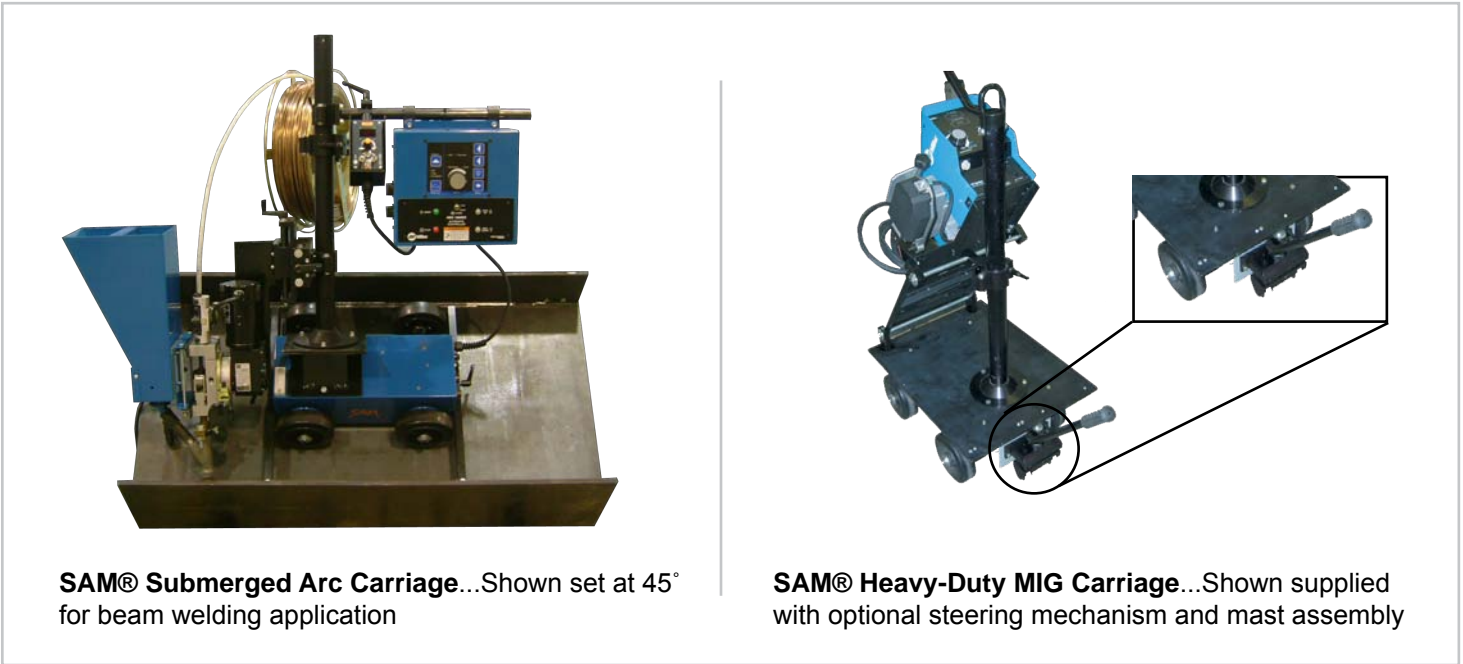

SAM® Submerged Arc Carriage...Shown set at 45° for beam welding application

SAM® Heavy-Duty MIG Carriage...Shown supplied with optional steering mechanism and mast assembly

Special track and wheels

-available upon request.

Power Supply: For operation on either 42/115/230 volts, single phase, 50/60 Hz AC.
(Specify voltage when placing order - B = 115 V, C = 230 V).

Speed Range: 4 to 66.1 IPM (10 to 168 cm/min)

Weight: 172 lbs (78 kg)

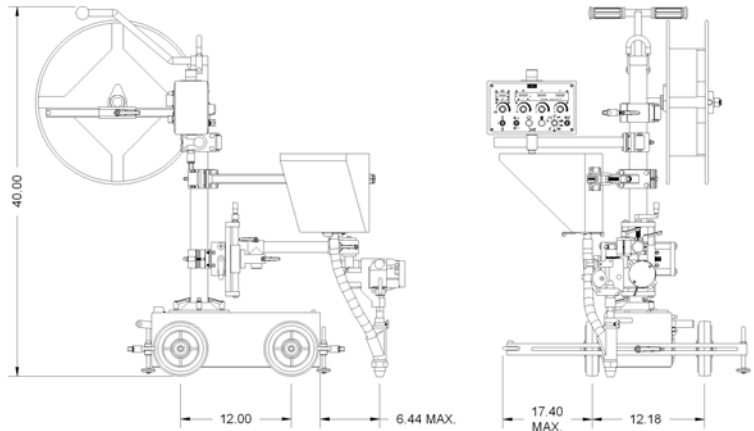

KAT, KBM, MOGGY, KATBAK & SAM are registered trademarks of Gullco Enterprises Limited

Distributed by:

SPECIFICATIONS ARE SUBJECT TO CHANGE WITHOUT NOTICE. ALL DIMENSIONS ARE NOMINAL

GULLCO

CANADA - GULLCO INTERNATIONAL LIMITED

Phone: 905-953-4140 Fax: 905-953-4138 e-mail: sales@gullco.com

U.S.A - GULLCO INTERNATIONAL INC.

Phone: 440-439-8333 Fax: 440-439-3634 e-mail: ussales@gullco.com

EUROPE - GULLCO INTERNATIONAL (U.K.) LIMITED

Phone: +44 1257-253579 Fax: +44 1257-254629 e-mail: uksales@gullco.com

AUSTRALIA - GULLCO INTERNATIONAL PTY LIMITED

Phone: 61 (0)7 3348 5515 Fax: 61 (0)7 3348 5510 e-mail: ausales@gullco.com

INDIA - GULLCO INTERNATIONAL INDIA PVT LIMITED

Phone: 91-20-6526-0382 Fax: 91-20-2683-6656 e-mail: indsales@gullco.com

CHINA - GULLCO INTERNATIONAL SHANGHAI LIMITED

Phone: +8621-50460341 Fax: +8621-50463554 e-mail: c.zhang@gullco.com

SINGAPORE - GULLCO INTERNATIONAL LIMITED

Phone: +65-9385-4468 e-mail: benny.lim@gullco.com

LATIN AMERICA - GULLCO INTERNATIONAL LIMITED

Phone: 55-11-99485-1336 e-mail: rogerio.macedo@gullco.com

Stuch GmbH & Co. KG Schweisstechnik - GERMANY

Phone: (02 03) 72 94 95 Fax: (02 03) 72 94 96 e-mail: info@stuch-schweisstechnik.de

AUTOMATED ROTARY WELD SYSTEM



Automate your circumferential welding operations, add efficiency and increased precision with the highly versatile Automatic Rotary Weld System

The rotary weld table with tack feedback interfaced with a PLC to provide precision stop/start, weld stop/start, adjustable rotation speed, weld overlap, multi-pass welding and tack welding

Accurately adjustable tailstock with 6" (152 mm) pneumatic clamping slide.

Motorized torch positioning slide to enable quick and easy loading/unloading of the work piece.

Maximum weight capacity 300 lbs (136 kg)

Table lengths up to 20 ft (6096 mm)



Increase Weld Quality and Improve Production with Automation

IDEAL FOR AUTOMATING PRODUCTION OF CYLINDRICAL PARTS INCLUDING: FLANGES AND END CAPS



SPECIFICATIONS

The Gullco Automatic Rotary Weld System is a low cost automated welding machine that produces consistent, precision welds on cylindrical work pieces. It is designed to provide repeatable quality welds, either in high or low production. It is easy to operate while providing sophisticated operational flexibility.

The Gullco Automatic Rotary Weld System comes complete with...

- Gullco programmable Motor Control interfaced with a PLC providing adjustable rotation speed, rotation stop/start, weld stop/start, wire feed stop/start and emergency stop controls, LED display for all functions
- Headstock...full 360° rotation with adjustable overlap, weld parameters controlled electronically
- Multi-pass Welding...available with automatic torch height adjustment
- Torch Support with rack arm and micro-slide rack box providing vertical torch adjustment, 4 axis torch holder assembly
- Tailstock...accurately adjustable with 6" (152 mm) pneumatic clamping slide
- The bed is heavy duty steel construction available in lengths up to 20 ft (6096 mm)

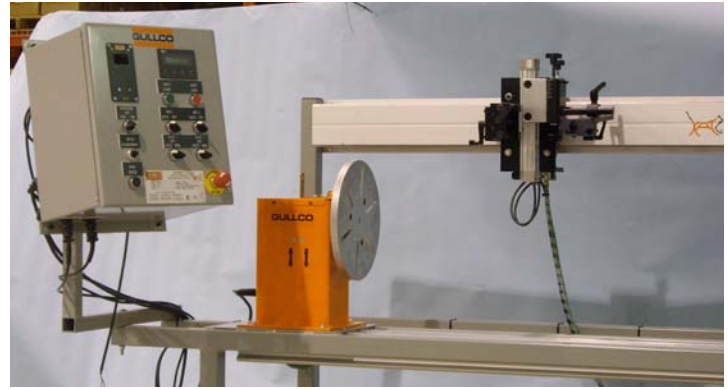

Load Capacity	300 lbs (136 kg)
Pneumatic Tailstock stroke	6" (152 mm)
Max. Part Length	to 20 ft (6096 mm)
Weld Diameters	to 18" (475 mm)
Adjustable Rotation Speed	0.25 - 15 rpm
Drive Motor	24 volt DC
Voltage	- for operation on either 115/230 volt, single phase, 50/60 Hz Ac power supply.

SPECIFY VOLTAGE WHEN PLACING ORDER

The Gullco Automatic Rotary Weld System is also available as a multi-torch system

KAT, KBM, MOGGY, KATBAK & SAM are registered trademarks of Gullco Enterprises Limited

Distributed by:

SPECIFICATIONS ARE SUBJECT TO CHANGE WITHOUT NOTICE. ALL DIMENSIONS ARE NOMINAL

GULLCO		
CANADA - GULLCO INTERNATIONAL LIMITED		
Phone: 905-953-4140	Fax: 905-953-4138	e-mail: sales@gullco.com
U.S.A - GULLCO INTERNATIONAL INC.		
Phone: 440-439-8333	Fax: 440-439-3634	e-mail: ussales@gullco.com
EUROPE - GULLCO INTERNATIONAL (U.K.) LIMITED		
Phone: +44 1257-253579	Fax: +44 1257-254629	e-mail: uksales@gullco.com
AUSTRALIA - GULLCO INTERNATIONAL PTY LIMITED		
Phone: 61 (0)7 3348 5515	Fax: 61 (0)7 3348 5510	e-mail: ausales@gullco.com
INDIA - GULLCO INTERNATIONAL INDIA PVT LIMITED		
Phone: 91-20-6526-0382	Fax: 91-20-2683-6656	e-mail: indsales@gullco.com
CHINA - GULLCO INTERNATIONAL SHANGHAI LIMITED		
Phone: +8621-50460341	Fax: +8621-50463554	e-mail: c.zhang@gullco.com
SINGAPORE - GULLCO INTERNATIONAL LIMITED		
Phone: +65-9385-4468		e-mail: benny.lim@gullco.com
LATIN AMERICA - GULLCO INTERNATIONAL LIMITED		
Phone: 55-11-99485-1336		e-mail: rogerio.macedo@gullco.com
Stuch GmbH & Co. KG Schweisstechnik - GERMANY		
Phone: (02 03) 72 94 95	Fax: (02 03) 72 94 96	e-mail: info@stuch-schweisstechnik.de



OVERLAY WELDING GANTRY SYSTEM FOR ALL POSITIONS

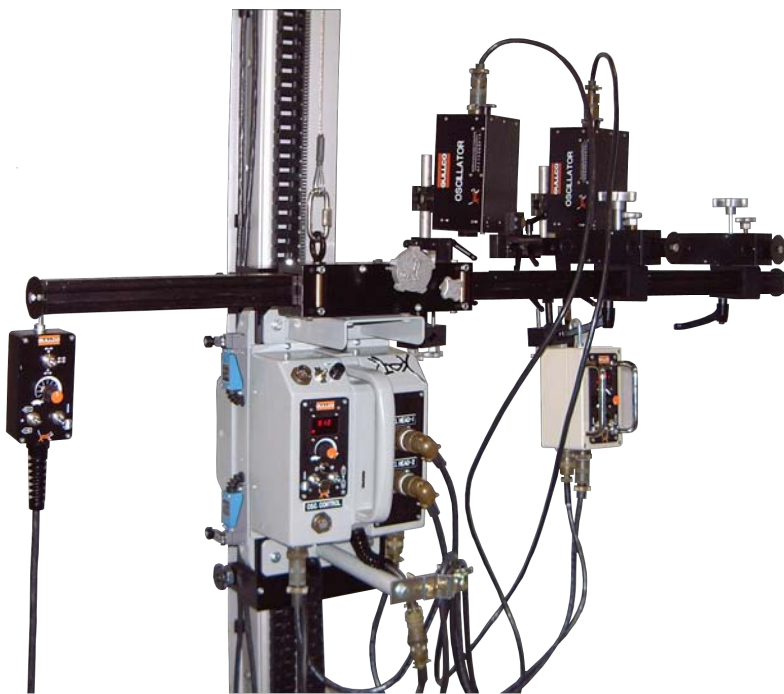

The Welding Overlay System is designed to operate in all positions. Ideal for use on boiler tube walls, cladding boiler tube walls prior to installation in the boiler, pressure vessel tanks and other applications where overlay repair is required.

The overlay system allows for precise control of the travel speed which allows the operator to achieve clean consistent weld overlay patterns.

The entire system is made up of existing Gullco products and can be easily disassembled into various smaller components for transporting or maneuvering through tighter openings.

Gullco's team of in-house engineers can customize the system to meet specific application requirements and this is used commonly for unique circumferences or wall applications.

The design of the overlay system is made to optimize time with a quick track mounting system which allows for easy alignment with the work piece.

Precise remote control of the overlay system ensures consistent weld quality

MOUNTS EASILY TO AUTOMATE OVERLAY AND CLADDING APPLICATIONS

WELDING AND CUTTING



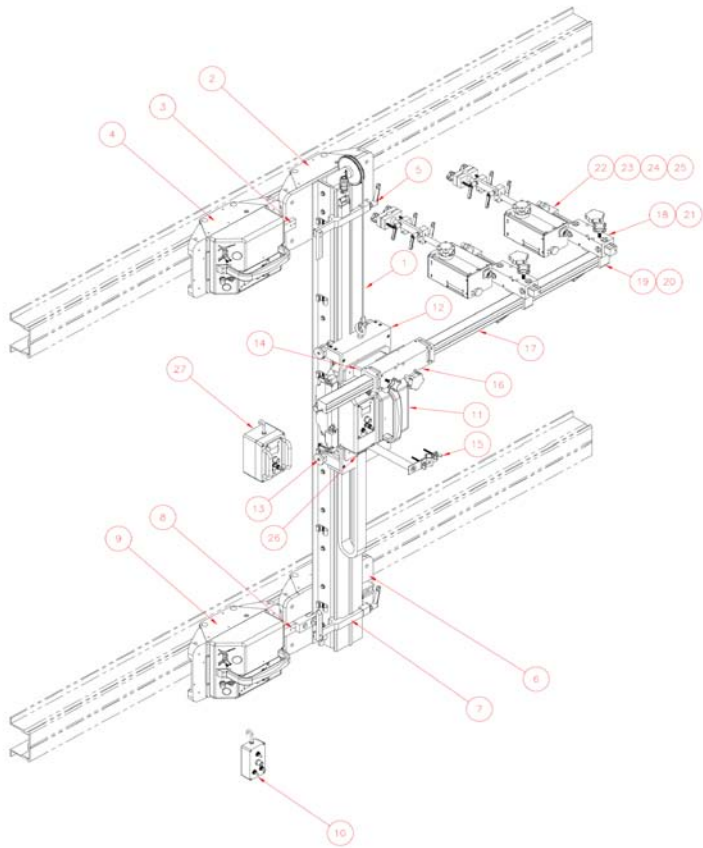

Item	Part Number	Description	Quantity
1	GS-474-024	VERTICAL TRACK ASSEMBLY	1
2	GS-474-013	UPPER IDLER CARRIAGE ASSEMBLY	1
3	GS-441-016	UPPER TOWING LINK	1
4	GS-474-035	UPPER KAT CARRIAGE ASSEMBLY	1
5	GS-474-047	MODIFIED TRACK STOP ASSEMBLY	1
6	GS-441-017	LOWER IDLER CARRIAGE ASSEMBLY	1
7	GK-191-P-061	RIGID TRACK STOP ASSEMBLY	1
8	GS-441-015	LOWER TOWING LINK	1
9	GS-474-030	LOWER KAT CARRIAGE ASSEMBLY	1
10	GS-441-021	REMOTE FOR UPPER & LOWER CARRIAGES	1
11	GS-474-055	VERTICAL KAT CARRIAGE ASSEMBLY (12-27)	1
12	GS-474-060	FRONT EXTENSION ASSEMBLY	1
13	GS-474-061	REAR EXTENSION ASSEMBLY	1
14	GK-190-066	RACK BOX RISER ASSEMBLY	1
15	GK-181-027	CABLE SUPPORT ASSEMBLY	1
16	GB-413-030	1 - 1/2" HEAVY DUTY RACK BOX	1
17	GS-474-070	1 - 1/2" RACK ARM X 48" LONG	1
18	GK-171-650	1 - 1/8" RACK BOX	2
19	GK-190-236	1 - 1/2" RACK ARM SQUARE CLAMP	2
20	GK-153-004	3/8 - 16 UNC FEMALE HAND LEVER	2
21	GK-171-047-1	1 - 1/8" RACK ARM x 12" LONG	2
22	GS-474-100	OSCILLATOR HEAD	2
23	GK-197-0-101	OSCILLATOR HEAD SWIVEL BRACKET	2
24	GK-197-0-102	BRONZE SWIVEL CLAMP ASSEMBLY	2
25	GK-171-112	ADAPTER BLOCK ASSEMBLY	2
26	GS-474-046	CABLE TRACK CLIP	1
27	GS-474-049	VERTICAL KAT REMOTE	1



OPTIONAL PRECISION COMPOUND SLIDES AVAILABLE



KAT, KBM, MOGGY, KATBAK & SAM are registered trademarks of Gullco Enterprises Limited

Distributed by:

SPECIFICATIONS ARE SUBJECT TO CHANGE WITHOUT NOTICE. ALL DIMENSIONS ARE NOMINAL

GULLCO

CANADA - GULLCO INTERNATIONAL LIMITED

Phone: 905-953-4140 Fax: 905-953-4138 e-mail: sales@gullco.com

U.S.A - GULLCO INTERNATIONAL INC.

Phone: 440-439-8333 Fax: 440-439-3634 e-mail: ussales@gullco.com

EUROPE - GULLCO INTERNATIONAL (U.K.) LIMITED

Phone: +44 1257-253579 Fax: +44 1257-254629 e-mail: uksales@gullco.com

AUSTRALIA - GULLCO INTERNATIONAL PTY LIMITED

Phone: 61 (0)7 3348 5515 Fax: 61 (0)7 3348 5510 e-mail: ausales@gullco.com

INDIA - GULLCO INTERNATIONAL INDIA PVT LIMITED

Phone: 91-20-6526-0382 Fax: 91-20-2683-6656 e-mail: indsales@gullco.com

CHINA - GULLCO INTERNATIONAL SHANGHAI LIMITED

Phone: +8621-50460341 Fax: +8621-50463554 e-mail: c.zhang@gullco.com

SINGAPORE - GULLCO INTERNATIONAL LIMITED

Phone: +65-9385-4468 e-mail: benny.lim@gullco.com

LATIN AMERICA - GULLCO INTERNATIONAL LIMITED

Phone: 55-11-99485-1336 e-mail: rogerio.macedo@gullco.com

Stuch GmbH & Co. KG Schweisstechnik - GERMANY

Phone: (02 03) 72 94 95 Fax: (02 03) 72 94 96 e-mail: info@stuch-schweisstechnik.de

WORLD LEADERS IN THE DESIGN,
MANUFACTURE & DISTRIBUTION OF AUTOMATED
WELDING SYSTEMS AND ACCESSORIES

CUT COSTS, IMPROVE QUALITY, AND INCREASE EFFICIENCY ...WITH THESE PROVEN
GULLCO PRODUCTS



KAT® SYSTEMS

- Oscillators
- Torch indexers
- Flex & Rigid KAT® Programmable Travel Carriages
- Seam Trackers
- Bridge Units
- Circle Cutting System

MOGGY®

- Trackless Fillet & Butt Welding, Stitch Welding control
- Radial Oscillation Control
- 6" V-groove Track Available

WELD PREP

- Bevellers
- Positioners
- Grippers
- Kamel Pipe
- Turning Rolls

OVENS

- Flux Rebake
- Flux Holding
- Flux Hoppers
- Electrode Stabilizing

CERAMIC BACKINGS

- KATBAK® Ceramic Weld Backing
- Impart Uniform X-Ray Quality Back Beads
- Eliminate Costly Grinding & Re-welds
- Knuckle Joints for Use On Flat or Curved Surfaces

CONTACT GULLCO OR YOUR GULLCO DISTRIBUTOR TODAY FOR INFORMATION ON ANY OF THESE PRODUCTS

KAT, KBM, MOGGY, KATBAK & SAM are registered trademarks of Gullco Enterprises Limited

SPECIFICATIONS ARE SUBJECT TO CHANGE WITHOUT NOTICE. ALL DIMENSIONS ARE NOMINAL

Distributed by:

GULLCO		
CANADA - GULLCO INTERNATIONAL LIMITED	Phone: 905-953-4140	Fax: 905-953-4138 e-mail: sales@gullco.com
U.S.A - GULLCO INTERNATIONAL INC.	Phone: 440-439-8333	Fax: 440-439-3634 e-mail: ussales@gullco.com
EUROPE - GULLCO INTERNATIONAL (U.K.) LIMITED	Phone: +44 1257-253579	Fax: +44 1257-254629 e-mail: uksales@gullco.com
AUSTRALIA - GULLCO INTERNATIONAL PTY LIMITED	Phone: 61 (0)7 3348 5515	Fax: 61 (0)7 3348 5510 e-mail: ausales@gullco.com
INDIA - GULLCO INTERNATIONAL INDIA PVT LIMITED	Phone: 91-20-6526-0382	Fax: 91-20-2683-6656 e-mail: indsales@gullco.com
CHINA - GULLCO INTERNATIONAL SHANGHAI LIMITED	Phone: +8621-50460341	Fax: +8621-50463554 e-mail: c.zhang@gullco.com
SINGAPORE - GULLCO INTERNATIONAL LIMITED	Phone: +65-9385-4468	e-mail: benny.lim@gullco.com
LATIN AMERICA - GULLCO INTERNATIONAL LIMITED	Phone: 55-11-99485-1336	e-mail: rogerio.macedo@gullco.com
Stuch GmbH & Co. KG Schweisstechnik - GERMANY	Phone: (02 03) 72 94 95	Fax: (02 03) 72 94 96 e-mail: info@stuch-schweisstechnik.de



CUSTOM GANTRY AND BRIDGE SYSTEMS



Gullco Gantry Units are custom designed assemblies that are used in a variety of applications such as automated seam welding, fabricated assemblies, stiffener seams and automated cutting operations such as stripping and edge preparation. **Gullco will custom design a gantry or bridge unit to meet your specific requirements.** A wide variety of custom design features and efficient, high end Gullco systems and components provide cost effective, reliable solutions for your welding and cutting automation needs.

Generate Accurate and Repeatable High Quality Weld Results

CUSTOM ENGINEERED TO AUTOMATE WELDING AND CUTTING OPERATIONS WITH PRECISION

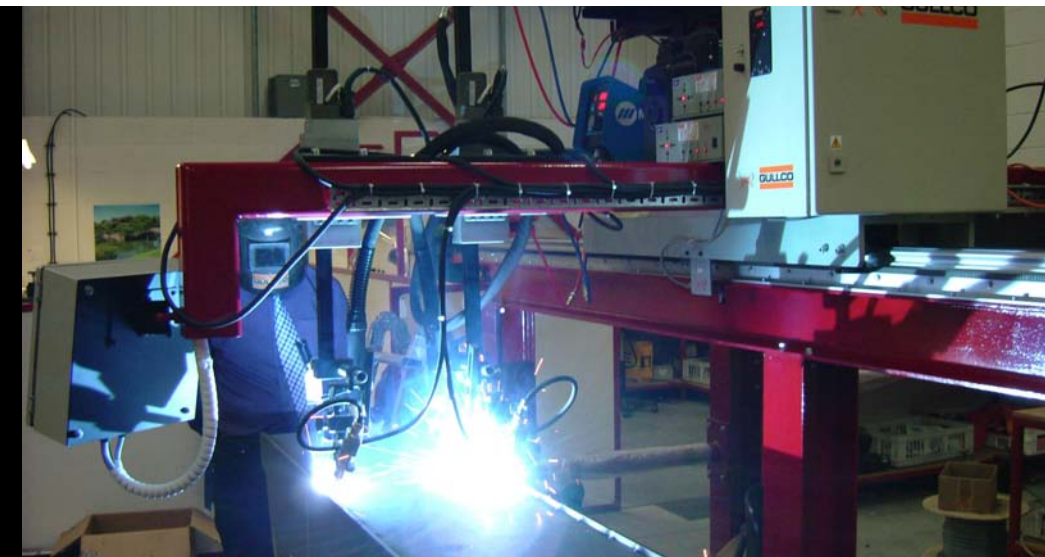

GANTRY BEAM - made from heavy duty track sections. spans range up to 18 ft.

WELDING GUN/CUTTING TORCH OR TOOL MOUNTING SYSTEMS - tailored to suit application requirements including mounting Seam Trackers, etc.

GANTRY SUPPORT CARRIAGES- Equipped with heavy duty cam type roller bearing assemblies.

LONGITUDINAL TRACK SECTIONS- interlocking design allows unlimited longitudinal travel.

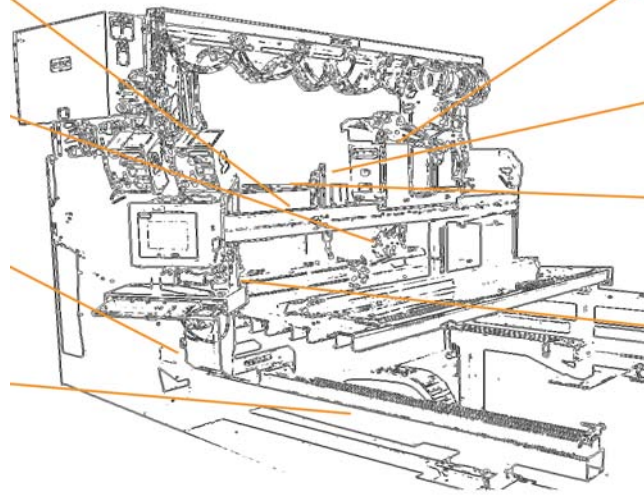

X-AXIS TRAVERSE CARRIAGE powered by Gullco KAT® 24volt gear motors.

Y-AXIS LONGITUDINAL DRIVE powered by Gullco low voltage, heavy duty drive systems.

CROSS DRIVE SHAFT- direct gear drive to each longitudinal track ensures accurate tracking of gantry.

CONTROL STATION- incorporates a touch screen 9460 industrial flat panel PC utilizing Citect HMI software to control functions such as automatic forward/reverse travel, variable speeds, automatic seam location/tracking and automatic operation of weld guns.

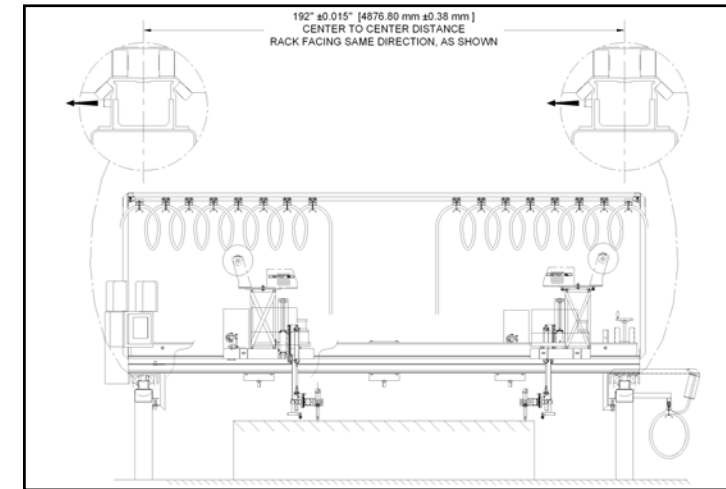

WELDING

This diagram shows a typical welding Gantry/Bridge unit design. The long tracks are located underneath the table providing protection. This also allows the work piece to be easily loaded at any point on the table as it is clear and easily accessible. The bridge unit can be equipped to automatically position and clamp the parts to be welded. It can also be supplied with mechanical, electronic or laser seam tracking equipment. Gullco can custom design a Gantry/Bridge system to meet your specific requirements.

LET GULLCO ENGINEER AND BUILD A GANTRY/BRIDGE SYSTEM FOR YOU
Seam Tracking is provided by Gullco designed vertical and horizontal tracking device.

GANTRY AND BRIDGE SYSTEM FEATURES



Touch screen industrial PC utilizing Citect HMI software.



Longitudinal track and cables are located underneath the table in protection.

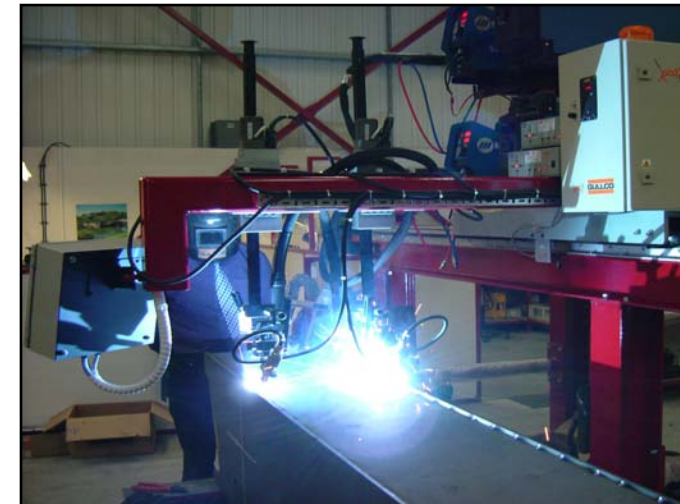

Gullco Gantry system is equipped with dual torches enabling simultaneous welds on both sides of aluminium trailer sidewall stiffeners in one pass.

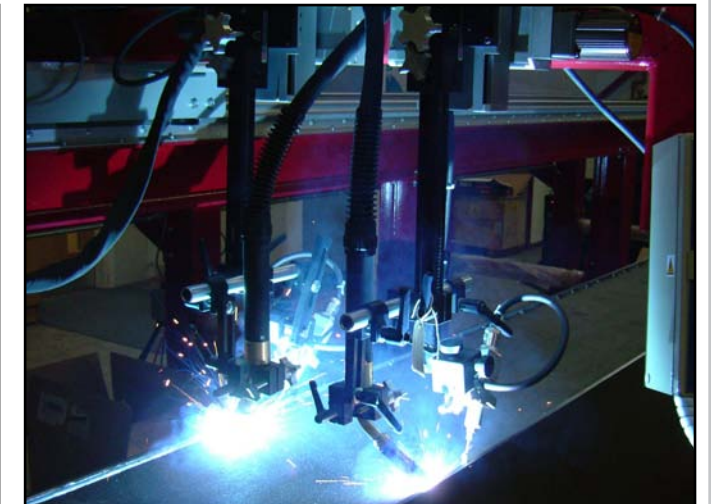

Seam tracking is provided by a Gullco designed vertical and horizontal tracking device.



Product Application File
 Kat-Trackers at
 Caterpillar Stockton

at Gullco's Appley Bridge, UK facility from 60% standard Gullco products. This enabled Gullco to meet critical delivery deadlines established to ensure Caterpillar production schedules were maintained. The machines are controlled by Mitsubishi PLC's programmed by Gullco [UK].

Gullco Equipment Used To Automate And Improve Productivity In Side Panel Welding At Caterpillar

The Caterpillar Stockton (UK) Ltd. plant selected Gullco International [UK] Limited to supply weld automation equipment/systems to improve quality and efficiency in a variety of M.I.G/M.A.G. welding applications. Gaffney Industrial and Welding Supplies Ltd. was chosen to support the sale and later service the Gullco equipment.

One of the applications involved Side Panel welding utilizing a twin torch system. The scope of

supply was for 4 complete, custom designed welding machines to be used for different jobs at the Caterpillar Stockton works facility. The unit pictured above shows a large Gullco travel carriage complete with wire feed units, fume extraction equipment, control equipment and two Gullco Kat-Tracker seam trackers. ITW, Miller welding machines with Binzel water cooled M.I.G/M.A.G. welding torches were selected for these demanding welding applications.

Fume extraction equipment was supplied by Nederman.

These large 6 to 12 meter long "turnkey" units were assembled totally "in-house"

Dual torches are used in these machines to substantially increase productivity and improve efficiency by welding two sides of a component simultaneously.



Above: Dual torches guided by Gullco Kat-Trackers simultaneously weld both sides of the work piece.





Left: Gullco Kat-Tracker probe with replaceable tip can be seen in the bottom left of the photo. They are precisely positioned relative to the torch prior to operation using a micro-cross-slide.

Below: Gullco Kat-Trackers continually sense the slightest variation across the weld seam and automatically correct the position of the weld torch.



Weld accuracy and quality are dependent on precise seam tracking and a reliable electrical interface of all

the components via the PLC. In order to meet the production and quality requirements at Caterpillar, the Gullco Kat-Tracker WSG-1200 was selected. These tactile seam trackers continually sense the slightest variation across the weld seam and automatically correct the position of the weld torch. They provide precise right/left and vertical/horizontal tracking plus automatic "tack detection" and "end-of-plate" detection. In total, eight Gullco Kat-Trackers were used in the 4 machines. Some use

100mm x 100mm slides where the work piece is approximately parallel to the fixture and each joint is approximately parallel to the other. In other cases the trackers were supplied with 150mm x 350mm slides to accommodate tapered work pieces.

As part of this project, Caterpillar purchased a Gullco GBM-28-U high speed portable, self-propelled plate edge bevelling machine. It is used to produce a clean machined bevel with no thermal distortion on thick

section plates at 2m/min. This rugged beveller with adjustable bevelling head can produce bevel angles 22 1/2° through 55°. The rotary shear principle incorporated by this machine results in low noise/vibration and high speed operation. This GBM-28-U unit bevells the under side of the plate.



Above/Below: GBM-28-U produces clean machined bevells on the underside of plate at up to 2 meters per minute using the rotary shear method of metal removal.



KAT, MOGGY, KATBAK & SAM are registered trademarks of Gullco Enterprises Limited

SPECIFICATIONS ARE SUBJECT TO CHANGE WITHOUT NOTICE

Distributed by:

WWW.GULLCO.COM

BULLETIN Gull-PAF-CATER-0705

GULLCO		
CANADA - GULLCO INTERNATIONAL LIMITED		
Phone: 905-953-4140	Fax: 905-953-4138	e-mail: sales@gullco.com
U.S.A - GULLCO INTERNATIONAL INC.		
Phone: 440-439-8333	Fax: 440-439-3634	e-mail: ussales@gullco.com
EUROPE - GULLCO INTERNATIONAL (U.K.) LIMITED		
Phone: +44 1257-253579	Fax: +44 1257-254629	e-mail: uksales@gullco.com
AUSTRALIA - GULLCO INTERNATIONAL PTY LIMITED		
Phone: 61 (0)7 3348 5515	Fax: 61 (0)7 3348 5510	e-mail: ausales@gullco.com
INDIA - GULLCO INTERNATIONAL INDIA PVT LIMITED		
Phone: 91-20-6526-0382	Fax: 91-20-2683-6656	e-mail: indsales@gullco.com
CHINA - GULLCO INTERNATIONAL SHANGHAI LIMITED		
Phone: +8621-50460341	Fax: +8621-50463554	e-mail: c.zhang@gullco.com
SINGAPORE - GULLCO INTERNATIONAL LIMITED		
Phone: +65-9385-4468		e-mail: benny.lim@gullco.com
LATIN AMERICA - GULLCO INTERNATIONAL LIMITED		
Phone: 55-11-99485-1336		e-mail: rogerio.macedo@gullco.com
Stuch GmbH & Co. KG Schweisstechnik - GERMANY		
Phone: (02 03) 72 94 95	Fax: (02 03) 72 94 96	e-mail: info@stuch-schweisstechnik.de



CERAMIC WELD BACKING TAPE - KATBAK®

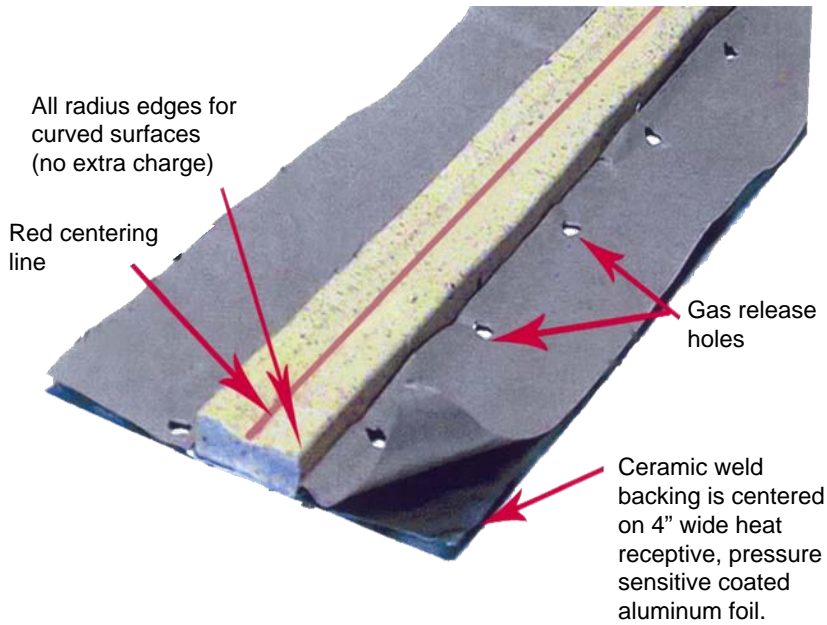

Impart x-ray quality back beads on the root pass.

Weld one side only

Deposit more weld metal

Eliminate defects and rework

Eliminate costly unnecessary gouging and grinding

Size 1/4" (6.3 mm) to 2" (51 mm) special sizes and configurations available

Conveniently packaged and sealed in plastic for moisture proof protection

Wider heat receptive pressure sensitive foil for improved adhesion to work piece



TANK BUILDING



PIPE WELDING



SHIP BUILDING



BRIDGE BUILDING

Quality Certification To: ISO 9000

IMPROVE WELD QUALITY AND REDUCE COST WITH KATBAK® CERAMIC WELD BACKING

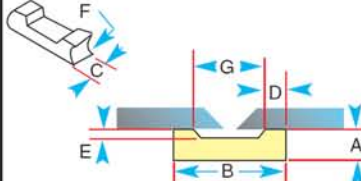
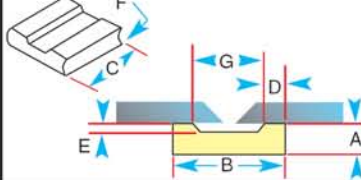
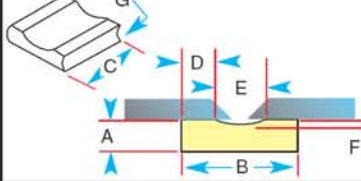
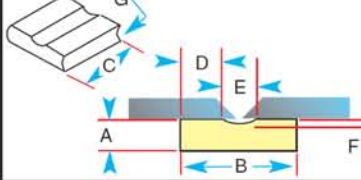
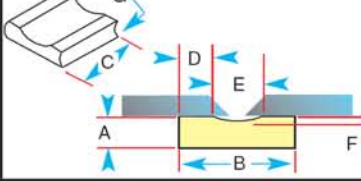
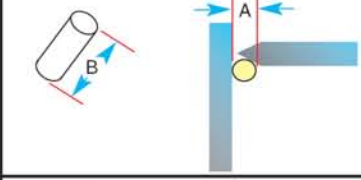
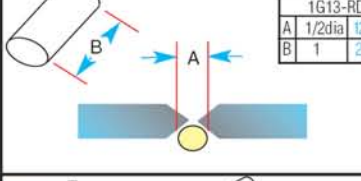
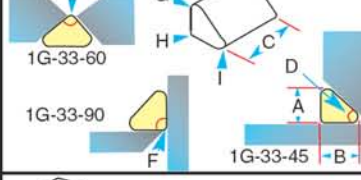
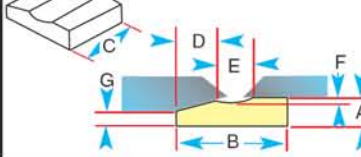

KATBAK® Ceramic Weld Backing Improves Weld Quality, Saves Time and Reduces Cost

MODEL	SPECIFICATION/TYPICAL APPLICATION	SPECS. inches / (mm)																														
1G93-R-1/4 (12m - 40ft/ box)	Similar to the 1G93-R tile but in 1/4" lengths making it much more flexible to wrap around smaller diameters of pipe and vessel. ✓	 <table border="1"> <tr><td>A</td><td>1/4</td><td>6.3</td></tr> <tr><td>B</td><td>7/8 to 1</td><td>22.2-25.4</td></tr> <tr><td>C</td><td>1/4</td><td>6.3</td></tr> <tr><td>D</td><td>5/32</td><td>4</td></tr> <tr><td>E</td><td>1/16</td><td>1.6</td></tr> <tr><td>F</td><td>3/16 r</td><td>4.8r</td></tr> <tr><td>G</td><td>7/16</td><td>11.1</td></tr> </table>	A	1/4	6.3	B	7/8 to 1	22.2-25.4	C	1/4	6.3	D	5/32	4	E	1/16	1.6	F	3/16 r	4.8r	G	7/16	11.1									
A	1/4	6.3																														
B	7/8 to 1	22.2-25.4																														
C	1/4	6.3																														
D	5/32	4																														
E	1/16	1.6																														
F	3/16 r	4.8r																														
G	7/16	11.1																														
1G93-R (12m - 40ft/ box)	This tile is most suitable for those applications where slag is involved, mainly M.A.G. welding with cored wire. It gives space for the slag to go while leaving a good root bead. Each tile is radiused to form a strip around the cylinder. ✓	 <table border="1"> <tr><td>A</td><td>1/4</td><td>6.3</td></tr> <tr><td>B</td><td>7/8 to 1</td><td>22.2-25.4</td></tr> <tr><td>C</td><td>1</td><td>25.4</td></tr> <tr><td>D</td><td>5/32</td><td>4</td></tr> <tr><td>E</td><td>1/16</td><td>1.6</td></tr> <tr><td>F</td><td>3/16 r</td><td>4.8r</td></tr> <tr><td>G</td><td>7/16</td><td>11.1</td></tr> </table>	A	1/4	6.3	B	7/8 to 1	22.2-25.4	C	1	25.4	D	5/32	4	E	1/16	1.6	F	3/16 r	4.8r	G	7/16	11.1									
A	1/4	6.3																														
B	7/8 to 1	22.2-25.4																														
C	1	25.4																														
D	5/32	4																														
E	1/16	1.6																														
F	3/16 r	4.8r																														
G	7/16	11.1																														
1G42-R (12m - 40ft/ box)	This tile is useful for M.I.G. welding with solid wires and metal cored wires. It is also useful for T.I.G. welding. Cored wires can also be used with this tile but smaller root reinforcement will be produced. Each tile is radiused to form the strip around a cylinder. ✓	 <table border="1"> <tr><td>A</td><td>1/4</td><td>6.3</td></tr> <tr><td>B</td><td>1</td><td>25.4</td></tr> <tr><td>C</td><td>1</td><td>25.4</td></tr> <tr><td>D</td><td>9/32</td><td>7.2</td></tr> <tr><td>E</td><td>7/16</td><td>11.1</td></tr> <tr><td>F</td><td>1/16</td><td>1.6</td></tr> <tr><td>G</td><td>3/16r</td><td>4.8r</td></tr> </table>	A	1/4	6.3	B	1	25.4	C	1	25.4	D	9/32	7.2	E	7/16	11.1	F	1/16	1.6	G	3/16r	4.8r									
A	1/4	6.3																														
B	1	25.4																														
C	1	25.4																														
D	9/32	7.2																														
E	7/16	11.1																														
F	1/16	1.6																														
G	3/16r	4.8r																														
1G43-R (12m - 40ft/ box)	This tile is for similar applications as the 1G42-R but where a narrower root bead is required. Each tile is radiused to form a strip around a cylinder. ✓	 <table border="1"> <tr><td>A</td><td>1/4</td><td>6.3</td></tr> <tr><td>B</td><td>1</td><td>25.4</td></tr> <tr><td>C</td><td>1</td><td>25.4</td></tr> <tr><td>D</td><td>3/8</td><td>9.5</td></tr> <tr><td>E</td><td>1/4</td><td>6.3</td></tr> <tr><td>F</td><td>1/16</td><td>1.6</td></tr> <tr><td>G</td><td>3/16r</td><td>4.8r</td></tr> </table>	A	1/4	6.3	B	1	25.4	C	1	25.4	D	3/8	9.5	E	1/4	6.3	F	1/16	1.6	G	3/16r	4.8r									
A	1/4	6.3																														
B	1	25.4																														
C	1	25.4																														
D	3/8	9.5																														
E	1/4	6.3																														
F	1/16	1.6																														
G	3/16r	4.8r																														
1G82-R (9m - 30ft/ box)	This tile is similar to the 1G42-R but it is thicker and more robust for heavier weld deposits and higher amperages. Each tile is radiused to form the strip around the cylinder. ✓	 <table border="1"> <tr><td>A</td><td>5/16</td><td>7.9</td></tr> <tr><td>B</td><td>1 1/4</td><td>31.7</td></tr> <tr><td>C</td><td>1</td><td>25.4</td></tr> <tr><td>D</td><td>13/32</td><td>10.3</td></tr> <tr><td>E</td><td>7/16</td><td>11.1</td></tr> <tr><td>F</td><td>1/16</td><td>1.6</td></tr> <tr><td>G</td><td>3/16r</td><td>4.8r</td></tr> </table>	A	5/16	7.9	B	1 1/4	31.7	C	1	25.4	D	13/32	10.3	E	7/16	11.1	F	1/16	1.6	G	3/16r	4.8r									
A	5/16	7.9																														
B	1 1/4	31.7																														
C	1	25.4																														
D	13/32	10.3																														
E	7/16	11.1																														
F	1/16	1.6																														
G	3/16r	4.8r																														
1G6-RD (12m - 40ft/ box) 1G9-RD (12m - 40ft/ box)	This is a 6mm round tile suitable for X preps, K preps and single bevel, single v butt joints (similar to fillet welds) on thin plates up to 10mm thick. Suitable for welding with M.I.G./M.A.G. solid, flux cored or metal cored wires. 1G9-RD is for use on thicker plates.	 <table border="1"> <tr><td colspan="3">1G6-RD</td></tr> <tr><td>A</td><td>1/4dia</td><td>6.3dia</td></tr> <tr><td>B</td><td>1</td><td>25.4</td></tr> <tr><td colspan="3">1G9-RD</td></tr> <tr><td>A</td><td>3/8dia</td><td>9.5dia</td></tr> <tr><td>B</td><td>1</td><td>25.4</td></tr> </table>	1G6-RD			A	1/4dia	6.3dia	B	1	25.4	1G9-RD			A	3/8dia	9.5dia	B	1	25.4												
1G6-RD																																
A	1/4dia	6.3dia																														
B	1	25.4																														
1G9-RD																																
A	3/8dia	9.5dia																														
B	1	25.4																														
1G13-RD (12m - 40ft/ box) 1G15-RD (12m - 40ft/ box) 1G20-RD (12m - 40ft/ box)	These tiles are for similar uses as the 1G6-RD but for thicker plates up to 15mm thick. Suitable for welding with M.I.G./M.A.G. solid, flux cored or metal cored wires. <i>can be used as shown</i>	 <table border="1"> <tr><td colspan="3">1G13-RD</td></tr> <tr><td>A</td><td>1/2dia</td><td>12.7dia</td></tr> <tr><td>B</td><td>1</td><td>25.4</td></tr> <tr><td colspan="3">1G15-RD</td></tr> <tr><td>A</td><td>5/8dia</td><td>15.9dia</td></tr> <tr><td>B</td><td>1</td><td>25.4</td></tr> <tr><td colspan="3">1G20-RD</td></tr> <tr><td>A</td><td>7/8dia</td><td>22.2dia</td></tr> <tr><td>B</td><td>1</td><td>25.4</td></tr> </table>	1G13-RD			A	1/2dia	12.7dia	B	1	25.4	1G15-RD			A	5/8dia	15.9dia	B	1	25.4	1G20-RD			A	7/8dia	22.2dia	B	1	25.4			
1G13-RD																																
A	1/2dia	12.7dia																														
B	1	25.4																														
1G15-RD																																
A	5/8dia	15.9dia																														
B	1	25.4																														
1G20-RD																																
A	7/8dia	22.2dia																														
B	1	25.4																														
1G33-45 (12m - 40ft/ box) 1G33-60 (12m - 40ft/ box) 1G33-90	All 1G33 tiles are suitable for K or X preps where the bevel angles are 45, 60 or 90 degrees. Also suitable for welding with M.I.G./M.A.G. solid wire, metal cored or flux cored wires. They are a substitute for round tiles where the benefit of the 1G33 range of tiles is a "full-face" contact with the joint preparation... reducing the risk of burn-through as may occur with the round tiles where you have a single point contact of the tile with the work piece. 1G33-90 also used when reverse side of a single bevel, single V butt joint where the reverse angle will always be 90°.	 <table border="1"> <tr><td colspan="3">1G33-45</td></tr> <tr><td>A</td><td>9/16</td><td>14.3</td></tr> <tr><td>B</td><td>5/8</td><td>15.9</td></tr> <tr><td>C</td><td>1</td><td>25.4</td></tr> <tr><td>D</td><td>40°</td><td>40°</td></tr> <tr><td>E</td><td>55°</td><td>55°</td></tr> <tr><td>F</td><td>85°</td><td>85°</td></tr> <tr><td>G</td><td>1/8 r</td><td>3.2 r</td></tr> <tr><td>H</td><td>7/64 r</td><td>2.8 r</td></tr> <tr><td>I</td><td>3/32 r</td><td>2.4 r</td></tr> </table>	1G33-45			A	9/16	14.3	B	5/8	15.9	C	1	25.4	D	40°	40°	E	55°	55°	F	85°	85°	G	1/8 r	3.2 r	H	7/64 r	2.8 r	I	3/32 r	2.4 r
1G33-45																																
A	9/16	14.3																														
B	5/8	15.9																														
C	1	25.4																														
D	40°	40°																														
E	55°	55°																														
F	85°	85°																														
G	1/8 r	3.2 r																														
H	7/64 r	2.8 r																														
I	3/32 r	2.4 r																														
1G62 (9m - 30ft/ box)	This tile is used when two plates to be welded are of a different thickness and is suitable for MIG welding with solid wire, metal core wire and can also be used with flux core wire.	 <table border="1"> <tr><td>A</td><td>21/64</td><td>8.3</td></tr> <tr><td>B</td><td>1 7/32</td><td>31</td></tr> <tr><td>C</td><td>1</td><td>25.4</td></tr> <tr><td>D</td><td>7/16</td><td>11.1</td></tr> <tr><td>E</td><td>7/16</td><td>11.1</td></tr> <tr><td>F</td><td>3/64</td><td>1.2</td></tr> <tr><td>G</td><td>11/64</td><td>4.4</td></tr> </table>	A	21/64	8.3	B	1 7/32	31	C	1	25.4	D	7/16	11.1	E	7/16	11.1	F	3/64	1.2	G	11/64	4.4									
A	21/64	8.3																														
B	1 7/32	31																														
C	1	25.4																														
D	7/16	11.1																														
E	7/16	11.1																														
F	3/64	1.2																														
G	11/64	4.4																														

✓ Available in 1/4" to 2" (6.3 mm to 50.8 mm) tiles

KATBAK® Ceramic Weld Backing Can Lay Root Weld & Fill In One Pass With X-Ray Quality Back Beads

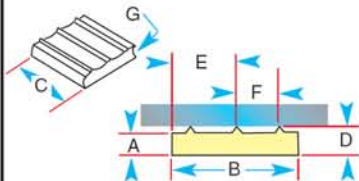
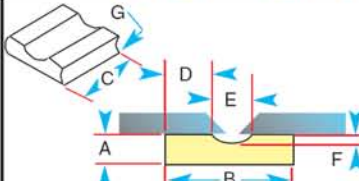
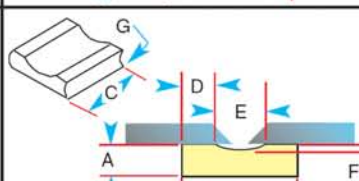
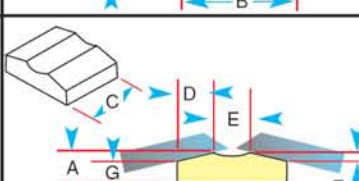
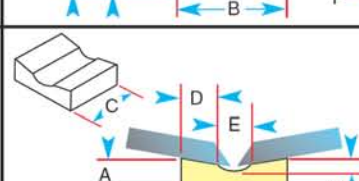
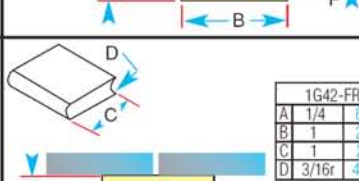
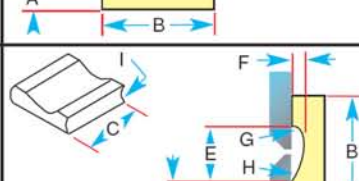
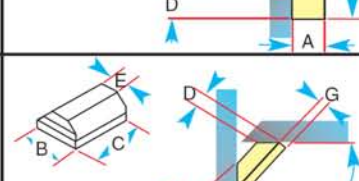
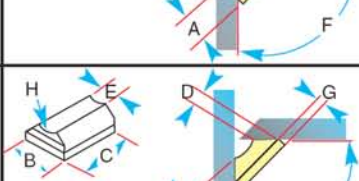
MODEL	SPECIFICATION/TYPICAL APPLICATION	SPECS. inches / (mm)																														
1G42-ER (12m - 40ft./ box)	This tile is suitable for use with M.I.G./M.A.G. applications with solid, flux or metal cored wires where minimal penetration is required but higher amperage is necessary because the small up-stands that are present in this tile will not burn away with amperages less than about 120 amps. Each tile is radiused to form the strip around a cylinder.	 <table border="1"> <tr><td>A</td><td>3/16</td><td>4.8</td></tr> <tr><td>B</td><td>1</td><td>25.4</td></tr> <tr><td>C</td><td>1</td><td>25.4</td></tr> <tr><td>D</td><td>5/64</td><td>6</td></tr> <tr><td>E</td><td>1/2</td><td>12.7</td></tr> <tr><td>F</td><td>11/32</td><td>8.7</td></tr> <tr><td>G</td><td>3/16 r</td><td>4.8r</td></tr> </table>	A	3/16	4.8	B	1	25.4	C	1	25.4	D	5/64	6	E	1/2	12.7	F	11/32	8.7	G	3/16 r	4.8r									
A	3/16	4.8																														
B	1	25.4																														
C	1	25.4																														
D	5/64	6																														
E	1/2	12.7																														
F	11/32	8.7																														
G	3/16 r	4.8r																														
1G41-R (12m - 40ft./ box)	This is similar to the 1G42-R but has a slightly smaller groove where more penetration is required than with the 1G42-R. Each tile is radiused to form a strip around a cylinder. ✓	 <table border="1"> <tr><td>A</td><td>1/4</td><td>6.3</td></tr> <tr><td>B</td><td>1</td><td>25.4</td></tr> <tr><td>C</td><td>1</td><td>25.4</td></tr> <tr><td>D</td><td>5/16</td><td>7.9</td></tr> <tr><td>E</td><td>3/8</td><td>9.5</td></tr> <tr><td>F</td><td>1/32</td><td>1</td></tr> <tr><td>G</td><td>3/16 r</td><td>4.8r</td></tr> </table>	A	1/4	6.3	B	1	25.4	C	1	25.4	D	5/16	7.9	E	3/8	9.5	F	1/32	1	G	3/16 r	4.8r									
A	1/4	6.3																														
B	1	25.4																														
C	1	25.4																														
D	5/16	7.9																														
E	3/8	9.5																														
F	1/32	1																														
G	3/16 r	4.8r																														
1G44-R (9m - 30ft./ box)	This tile is a larger tile and has a larger groove than the 1G42 tile or the 1G41-R tile where the user needs more penetration and more substance in the tile. Possibly for submerged arc welding applications and thicker plates. Each tile is radiused to form a strip around the cylinder. ✓	 <table border="1"> <tr><td>A</td><td>3/8</td><td>9.5</td></tr> <tr><td>B</td><td>1 1/4</td><td>31.7</td></tr> <tr><td>C</td><td>1</td><td>25.4</td></tr> <tr><td>D</td><td>9/32</td><td>7.2</td></tr> <tr><td>E</td><td>11/16</td><td>17.5</td></tr> <tr><td>F</td><td>1/16</td><td>1.6</td></tr> <tr><td>G</td><td>1/4 r</td><td>6.3r</td></tr> </table>	A	3/8	9.5	B	1 1/4	31.7	C	1	25.4	D	9/32	7.2	E	11/16	17.5	F	1/16	1.6	G	1/4 r	6.3r									
A	3/8	9.5																														
B	1 1/4	31.7																														
C	1	25.4																														
D	9/32	7.2																														
E	11/16	17.5																														
F	1/16	1.6																														
G	1/4 r	6.3r																														
1G61 (12.2m - 40ft./box)	This is for inserting behind plates where there is a taper on the backside of the plate. This tile allows the groove portion to fit snugly against the root. Note that these tiles are square edged and so, will not go round a radius. They are meant for flat plates. Again, these tiles are used for M.I.G./M.A.G. welding with all the wires. ✓	 <table border="1"> <tr><td>A</td><td>3/8</td><td>9.5</td></tr> <tr><td>B</td><td>1 7/32</td><td>31</td></tr> <tr><td>C</td><td>1</td><td>25.4</td></tr> <tr><td>D</td><td>25/64</td><td>10</td></tr> <tr><td>E</td><td>7/16</td><td>11.1</td></tr> <tr><td>F</td><td>1/32</td><td>.79</td></tr> <tr><td>G</td><td>1/4</td><td>6.3</td></tr> </table>	A	3/8	9.5	B	1 7/32	31	C	1	25.4	D	25/64	10	E	7/16	11.1	F	1/32	.79	G	1/4	6.3									
A	3/8	9.5																														
B	1 7/32	31																														
C	1	25.4																														
D	25/64	10																														
E	7/16	11.1																														
F	1/32	.79																														
G	1/4	6.3																														
1G60 (9m - 30 ft./ box)	This tile has upturned sides for use when the plates are introduced at an angle or with differing thicknesses to allow the root of the weldment to sit snugly against the tile and present next to the radiused portion where the root will form. ✓	 <table border="1"> <tr><td>A</td><td>3/8</td><td>9.5</td></tr> <tr><td>B</td><td>1 3/16</td><td>30.2</td></tr> <tr><td>C</td><td>1</td><td>25.4</td></tr> <tr><td>D</td><td>3/8</td><td>9.5</td></tr> <tr><td>E</td><td>7/16</td><td>11.1</td></tr> <tr><td>F</td><td>9/64</td><td>3.6</td></tr> </table>	A	3/8	9.5	B	1 3/16	30.2	C	1	25.4	D	3/8	9.5	E	7/16	11.1	F	9/64	3.6												
A	3/8	9.5																														
B	1 3/16	30.2																														
C	1	25.4																														
D	3/8	9.5																														
E	7/16	11.1																														
F	9/64	3.6																														
1G42-FR (12m - 40ft./ box) 1G83-FR (9m - 30 ft./ box) 1G42-FR-1/4 (12m - 40ft./ box)	This tile is similar to the standard flat tile but it is more flexible to go round a tighter radius. Please note that all other tile shapes can be made 1/4" long to aid flexibility of the tile. Each tile is radiused to form a strip around a cylinder. 1G83-FR This is similar to the 1G42-FR but it is a thicker, larger tile to withstand higher currents where minimal penetration is required. ✓	 <table border="1"> <tr><td colspan="3">1G83-FR</td></tr> <tr><td>A</td><td>5/16</td><td>7.9</td></tr> <tr><td>B</td><td>1 1/4</td><td>31.7</td></tr> <tr><td>C</td><td>1</td><td>25.4</td></tr> <tr><td>D</td><td>3/16r</td><td>4.8r</td></tr> <tr><td colspan="3">1G42-FR-1/4</td></tr> <tr><td>A</td><td>1/4</td><td>6.3</td></tr> <tr><td>B</td><td>1</td><td>25.4</td></tr> <tr><td>C</td><td>1/4</td><td>6.3</td></tr> <tr><td>D</td><td>3/16r</td><td>4.8r</td></tr> </table>	1G83-FR			A	5/16	7.9	B	1 1/4	31.7	C	1	25.4	D	3/16r	4.8r	1G42-FR-1/4			A	1/4	6.3	B	1	25.4	C	1/4	6.3	D	3/16r	4.8r
1G83-FR																																
A	5/16	7.9																														
B	1 1/4	31.7																														
C	1	25.4																														
D	3/16r	4.8r																														
1G42-FR-1/4																																
A	1/4	6.3																														
B	1	25.4																														
C	1/4	6.3																														
D	3/16r	4.8r																														
1G80-R (12m - 40 ft./ box)	This tile is specially designed to prevent back bead droop in horizontal welding and can be used with MIG welding with solid wire, metal core wire and can also be used with flux core wire. ✓	 <table border="1"> <tr><td>A</td><td>1/4</td><td>6.3</td></tr> <tr><td>B</td><td>1</td><td>25.4</td></tr> <tr><td>C</td><td>1</td><td>25.4</td></tr> <tr><td>D</td><td>1/4</td><td>6.3</td></tr> <tr><td>E</td><td>1/2</td><td>12.7</td></tr> <tr><td>F</td><td>3/32</td><td>2.4</td></tr> <tr><td>G</td><td>3/32 r</td><td>2.4 r</td></tr> <tr><td>H</td><td>3/4 r</td><td>19. r</td></tr> <tr><td>I</td><td>3/16 r</td><td>4.8 r</td></tr> </table>	A	1/4	6.3	B	1	25.4	C	1	25.4	D	1/4	6.3	E	1/2	12.7	F	3/32	2.4	G	3/32 r	2.4 r	H	3/4 r	19. r	I	3/16 r	4.8 r			
A	1/4	6.3																														
B	1	25.4																														
C	1	25.4																														
D	1/4	6.3																														
E	1/2	12.7																														
F	3/32	2.4																														
G	3/32 r	2.4 r																														
H	3/4 r	19. r																														
I	3/16 r	4.8 r																														
1G66-B (12m - 40ft./ box)	This is for fitting behind a single bevel, single v butt where a fillet weld must be produced on the backside of the joint during welding on the front side of the joint... possibly where access for welding or repairs is not possible. This tile will produce a mitered fillet. ✓	 <table border="1"> <tr><td>A</td><td>11/32</td><td>8.7</td></tr> <tr><td>B</td><td>3/4</td><td>19</td></tr> <tr><td>C</td><td>1</td><td>25.4</td></tr> <tr><td>D</td><td>7/32</td><td>5.6</td></tr> <tr><td>E</td><td>5/16</td><td>7.9</td></tr> <tr><td>F</td><td>90°</td><td>90°</td></tr> <tr><td>G</td><td>1/8</td><td>3.2</td></tr> </table>	A	11/32	8.7	B	3/4	19	C	1	25.4	D	7/32	5.6	E	5/16	7.9	F	90°	90°	G	1/8	3.2									
A	11/32	8.7																														
B	3/4	19																														
C	1	25.4																														
D	7/32	5.6																														
E	5/16	7.9																														
F	90°	90°																														
G	1/8	3.2																														
1G65-B (12m - 40ft./ box)	Similar applications to the 1G66-B but the fillet weld produced will be a convex radiused fillet instead of a mitered fillet. ✓	 <table border="1"> <tr><td>A</td><td>5/16</td><td>7.9</td></tr> <tr><td>B</td><td>7/8</td><td>22.2</td></tr> <tr><td>C</td><td>1</td><td>25.4</td></tr> <tr><td>D</td><td>7/32</td><td>5.6</td></tr> <tr><td>E</td><td>7/16</td><td>11.1</td></tr> <tr><td>F</td><td>90°</td><td>90°</td></tr> <tr><td>G</td><td>3/32</td><td>2.4</td></tr> <tr><td>H</td><td>9/16 r</td><td>14.3 r</td></tr> </table>	A	5/16	7.9	B	7/8	22.2	C	1	25.4	D	7/32	5.6	E	7/16	11.1	F	90°	90°	G	3/32	2.4	H	9/16 r	14.3 r						
A	5/16	7.9																														
B	7/8	22.2																														
C	1	25.4																														
D	7/32	5.6																														
E	7/16	11.1																														
F	90°	90°																														
G	3/32	2.4																														
H	9/16 r	14.3 r																														

✓ Available in 1/4" to 2" (6.3 mm to 50.8 mm) tiles

As a manufacturer and distributor of ceramics, Gullco can provide you with a KATBAK® ceramic weld backing to meet your needs. If you do not see the ceramic you need in this brochure contact Gullco or your Gullco distributor to discuss your specific requirement.

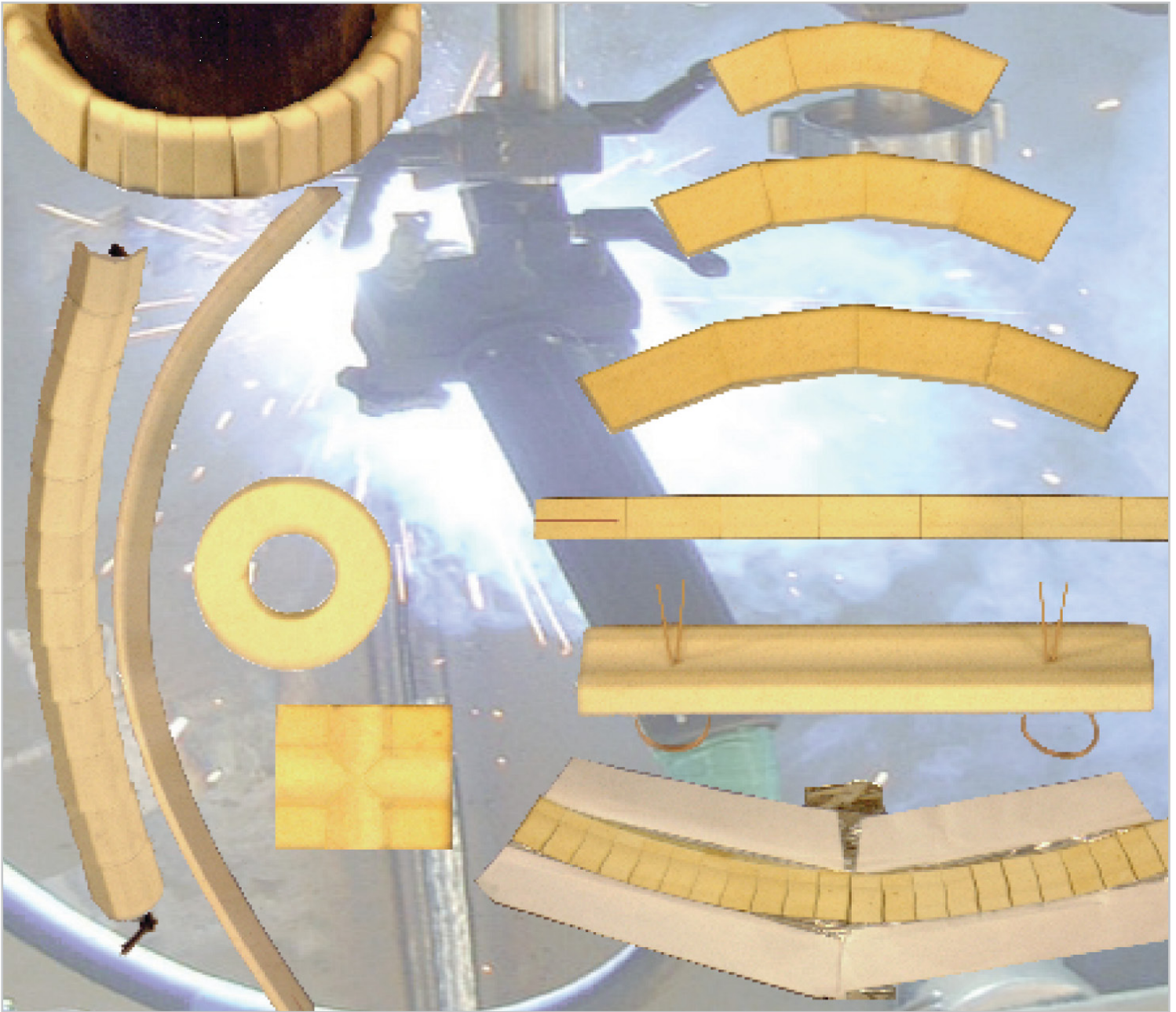

KAT, KBM, MOGGY, KATBAK & SAM are registered trademarks of Gullco Enterprises Limited

SPECIFICATIONS ARE SUBJECT TO CHANGE WITHOUT NOTICE. ALL DIMENSIONS ARE NOMINAL

Distributed by:

GULLCO

CANADA - GULLCO INTERNATIONAL LIMITED

Phone: 905-953-4140 Fax: 905-953-4138 e-mail: sales@gullco.com

U.S.A - GULLCO INTERNATIONAL INC.

Phone: 440-439-8333 Fax: 440-439-3634 e-mail: ussales@gullco.com

EUROPE - GULLCO INTERNATIONAL (U.K.) LIMITED

Phone: +44 1257-253579 Fax: +44 1257-254629 e-mail: uksales@gullco.com

AUSTRALIA - GULLCO INTERNATIONAL PTY LIMITED

Phone: 61 (0)7 3348 5515 Fax: 61 (0)7 3348 5510 e-mail: ausales@gullco.com

INDIA - GULLCO INTERNATIONAL INDIA PVT LIMITED

Phone: 91-20-6526-0382 Fax: 91-20-2683-6656 e-mail: indsales@gullco.com

CHINA - GULLCO INTERNATIONAL SHANGHAI LIMITED

Phone: +8621-50460341 Fax: +8621-50463554 e-mail: c.zhang@gullco.com

SINGAPORE - GULLCO INTERNATIONAL LIMITED

Phone: +65-9385-4468 e-mail: benny.lim@gullco.com

LATIN AMERICA - GULLCO INTERNATIONAL LIMITED

Phone: 55-11-99485-1336 e-mail: rogerio.macedo@gullco.com

Stuch GmbH & Co. KG Schweistechnik - GERMANY

Phone: (02 03) 72 94 95 Fax: (02 03) 72 94 96 e-mail: info@stuch-schweisstechnik.de

WWW.GULLCO.COM

KB-11-01



PIPE WELDING TURNING ROLLS - KAMEL ROLLS



Reduce pipe preparation costs with these portable automated turning rolls which rotates pipe from 2" to 16" (51- 406 mm) diameter. Two models are available; Model **KR-200-L** has a turning capacity of 1500 lbs (680 kg), and an infinitely variable forward/reverse speed range of 1-35.4 IPM (2.5-89.9 cm/min). Model **KR-200-M** has a turning capacity of 1500 lbs (680 kg) and an infinitely variable forward/reverse speed range of 2.2-70.8 IPM (5.6-180 cm/min). Rotation speed is precisely controlled and displayed in inches/mm per minute on an LED readout. Contact Gullco or your Gullco distributor for complete details on these highly efficient, cost effective turning rolls.

Electronic controls are immune to damage from high frequency and electromagnetic interference.

Portable: total weight of power and idler roll is 69 lbs. (31.3 kg). Use anywhere that 42, 115 or 220-240 volts 50/60 cycle single phase power supply is available.

Long life, 6" (15.24 cm) diameter roller bearing wheels with rubber tires provide friction drive and uniformly smooth pipe rotation.

Protected on/off foot switch on 7.5 ft (2.3 m) cable provides maximum convenience and freedom for operator.



Great For In-shop Pipe Manufacturing Applications

AUTOMATION PIPE TURNING ROLLS WITH FOOTSWITCH: KR-200-L AND KR-200-M

WELDING AND CUTTING



SPECIFICATIONS

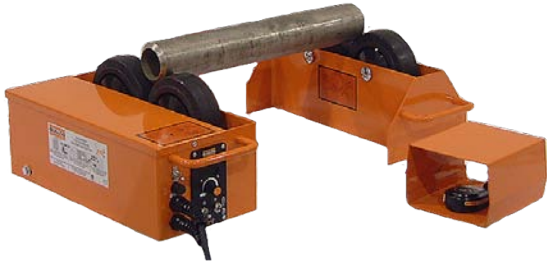

	POWER ROLLS	
	Model KR-200-L	Model KR-200-M
TURNING CAPACITY	1500 lbs (680 kg)	1500 lbs (680 kg)
LOAD CAPACITY/ROLL	750 lbs (340 kg)	750 lbs (340 kg)
PIPE DIA. RANGE	2"-16" (51-406 mm)	2"-16" (51-406 mm)
SPEED RANGE	1-35.4 IPM (2.5-89.9 cm/min)	2.2-70.8 IPM (5.6-180 cm/min)
WEIGHT	48 lbs (21.8 kg)	48 lbs (21.8 kg)
	IDLER ROLLS Model KR-750	
LOAD CAPACITY	750 lbs (340 kg)	
PIPE DIA. RANGE	2"-16" (51-406 mm)	
WEIGHT	21 lbs (9.5 kg)	

DIMENSIONS: POWER AND IDLER ROLLS

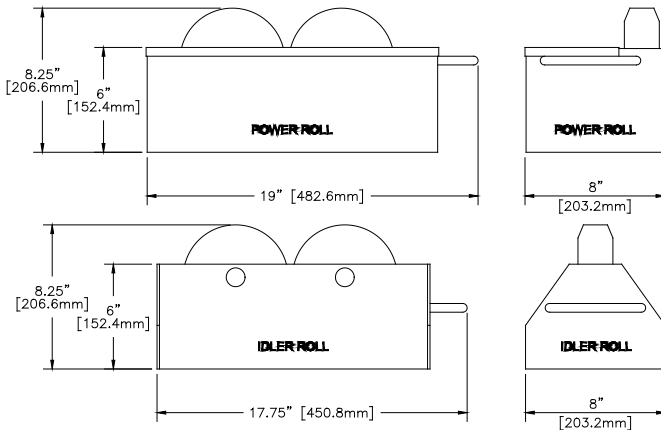

KAT, KBM, MOGGY, KATBAK & SAM are registered trademarks of Gullco Enterprises Limited

Distributed by:

FREE STANDING TORCH SUPPORTS AND TORCH / GUN HOLDERS

MODEL KR-1000 CSB TORCH SUPPORT 1 1/8" (28.6mm) square rack arms providing 22" (559 mm) of vertical adjustment and 10 1/2" (266.7 mm) of horizontal adjustment.

MODEL KR-2000 CSB TORCH SUPPORT Same as above but 1 1/2" (38.1mm) square rack arms providing 18" (457 mm) vertical adjustment and 6.5" (165 mm) of horizontal adjustment. Supplied with swivel mounted standard rack-type cutting torch holder.

Weight: 42 lbs (19.05 kg)

MODEL KR-1000 WSB TORCH SUPPORT 1 1/8" (28.6 mm) square rack arm providing 22" (559mm) of vertical adjustment and 10 1/2" (266.7mm) of horizontal adjustment. Weight: 25 lbs. (11.34kg)

MODEL KR-2000 WSB TORCH SUPPORT Same as above but 1 1/2" (38.1mm) square rack arms providing 18" (457 mm) vertical adjustment and 6.5" (165 mm) of horizontal adjustment. Supplied with insulated 4 motion, semi-automatic gun holder and swivel arm that allows adjustment of gun angle tilt.

Weight: 42 lbs. (19.05 kg)

NOTE:

The above models can be, and often are, supplied with the Gullco Motorized Rack Arm, equipped with a remote joystick control. See www.gullco.com for more information.



GULLCO



SPECIFICATIONS ARE SUBJECT TO CHANGE WITHOUT NOTICE. ALL DIMENSIONS ARE NOMINAL

GULLCO

CANADA - GULLCO INTERNATIONAL LIMITED

Phone: 905-953-4140 Fax: 905-953-4138 e-mail: sales@gullco.com

U.S.A - GULLCO INTERNATIONAL INC.

Phone: 440-439-8333 Fax: 440-439-3634 e-mail: ussales@gullco.com

EUROPE - GULLCO INTERNATIONAL (U.K.) LIMITED

Phone: +44 1257-253579 Fax: +44 1257-254629 e-mail: uksales@gullco.com

AUSTRALIA - GULLCO INTERNATIONAL PTY LIMITED

Phone: 61 (0)7 3348 5515 Fax: 61 (0)7 3348 5510 e-mail: ausales@gullco.com

INDIA - GULLCO INTERNATIONAL INDIA PVT LIMITED

Phone: 91-20-6526-0382 Fax: 91-20-2683-6656 e-mail: indsales@gullco.com

CHINA - GULLCO INTERNATIONAL SHANGHAI LIMITED

Phone: +8621-50460341 Fax: +8621-50463554 e-mail: c.zhang@gullco.com

SINGAPORE - GULLCO INTERNATIONAL LIMITED

Phone: +65-9385-4468 e-mail: benny.lim@gullco.com

LATIN AMERICA - GULLCO INTERNATIONAL LIMITED

Phone: 55-11-99485-1336 e-mail: rogerio.macedo@gullco.com

Stuch GmbH & Co. KG Schweisstechnik - GERMANY

Phone: (02 03) 72 94 95 Fax: (02 03) 72 94 96 e-mail: info@stuch-schweisstechnik.de

AUTOMATED WELDING POSITIONER



These welding positioners are positive drive rotary turn tables complete with mounting flange, drive and tilt mechanisms which incorporates a microprocessor based pulse width modulation motor control. Standard and Programmable models are available. The welding positioners are driven by a low voltage permanent magnet motor and gear head power unit assembly. The microprocessor motor control enables operator interface of start, stop, clockwise rotation and infinitely variable control of the speed, within the range of the model.

Rotation speed is electronically controlled using an optical tachometer located on the back of the gear-motor. Speeds within the range of the model are infinitely variable in both clockwise and counter-clockwise directions through a rotary speed adjustment potentiometer located on the remote control. Table tilt is manually set at any desired angle, from 0° through 90°, quickly and easily. Safety is greatly enhanced with Gullco low voltage (24 V) control and power supply system.



Increase Productivity, Quality and Profitability with Automation

AVAILABLE WITH A 2" THROUGH HOLE FOR LONGER WORK PIECES

GULLCO

WELDING AND CUTTING



GP/GPP 200 SERIES POSITIONERS ARE AVAILABLE IN STANDARD OR PROGRAMMABLE MODELS WHICH ARE EQUIPPED WITH CORRESPONDING REMOTE CONTROLS

STANDARD

The Standard Remote Control provides

- infinitely variable rotation speed within the model's speed range,
- forward/neutral/reverse switch,
- run/stop switch
- speed potentiometer



PROGRAMMABLE

The Programmable Remote Control with LED readout provides

- infinitely variable rotation speed within the model's speed range,
- forward/neutral/reverse switch,
- run/stop switch
- programmable microprocessor providing adjustable positioning timing cycles, amount of weld rotation, weld on/weld off through 360° and a signal to activate a pneumatically operated weld gun holder and wire feed arc activation.

FOOTSWITCHES (optional)

Three footswitch models are available;

GP-200-024 - Run/Stop footswitch assembly for manual operation. This kit provides a run/ stop footswitch; a footswitch guard cover; a connecting control cable; and strain relief glands. When activated, the footswitch will provide a run signal to the control.



GP-200-025 - Variable Speed footswitch assembly for manual operation. This kit provides a run/stop/variable speed footswitch; a footswitch guard cover; a connecting control cable; and strain relief glands. When activated, the footswitch will provide a run signal to the control and allow regulation of the rotational speed via the compression of the footswitch pedal.

GP-200-023 - Forward/Stop/Reverse footswitch assembly for manual operation. This kit provides a directional footswitch; a footswitch guard cover; a connecting control cable; and strain relief glands. When activated, the footswitch will provide a run signal and rotary direction signal to the control.

PURGE-EQUIPPED MODELS,

have a 1/4" (6.4 mm) hole through the centre of the table drive shaft and a gas rotary coupling mounted on the underside of the table ... the shaft having a 1/4" NTP tapped gas inlet hole.

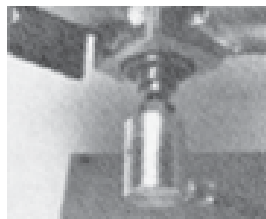

GULLCO SELF-CENTERING WELDING GRIPPER

(optional) The **WPG-250** Gripper is quickly and easily mounted on any make of positioner, turntable or tailstock. They are slim but durable, weighing only about half that of a standard chuck, minimizing reduction in positioner capacity. Single lever operation provides smooth, positive self-centering action.



MOUNTING TABLE (optional) **GP-200-016**

12" (305mm) diameter mounting table. This round mounting table is used to facilitate direct mounting of components or fixtures and provides (6) radial mounting slots and various (3) hole pitch circle bolt patterns. The mounting table is quickly and easily mounted on the positioner spindle flange.



Gullco offers a wide range of accessories that provide low cost welding/cutting automation solutions including..



KR-1000 WSB free standing support and welding gun holder assembly. 1- 1/8" (28.6mm) square rack arms and rack boxes provide 22" (558.8 mm) of vertical adjustment and 10-1/2 (266.7mm) of horizontal adjustment. Supplied with swivel mounted, adjustable gun holder assembly.

KR-1000 & 2000 WSB

KR-2000 WSB Same as above, except uses 1-1/2" (38.1mm) rack arms and rack boxes and provides 18" (457.2 mm) of vertical and 6-1/2" (165.1 mm) of horizontal adjustment.

KR-1000 CSB & KR-2000 CSB are the same as above except they are supplied with swivel mounted, standard rack-type cutting torch holder instead of welding gun holder

CUSTOMIZED AUTOMATION

The above cutting torch and welding gun support assemblies can be, and often are, equipped with one or two Gullco motorized rack arms controlled by a remote joystick pendant.



KR-1000 & 2000 CSB

Model GP-300/350

These "Through Hole" Positioners models are designed with a 2.5 inch (63 mm) "through hole" so the workpiece can be passed through the unit (max material of 2 3/8 OD) making production on long pieces easier and faster.



Pass through Hole Workpiece Passes Through The Positioner

SPECIFICATIONS

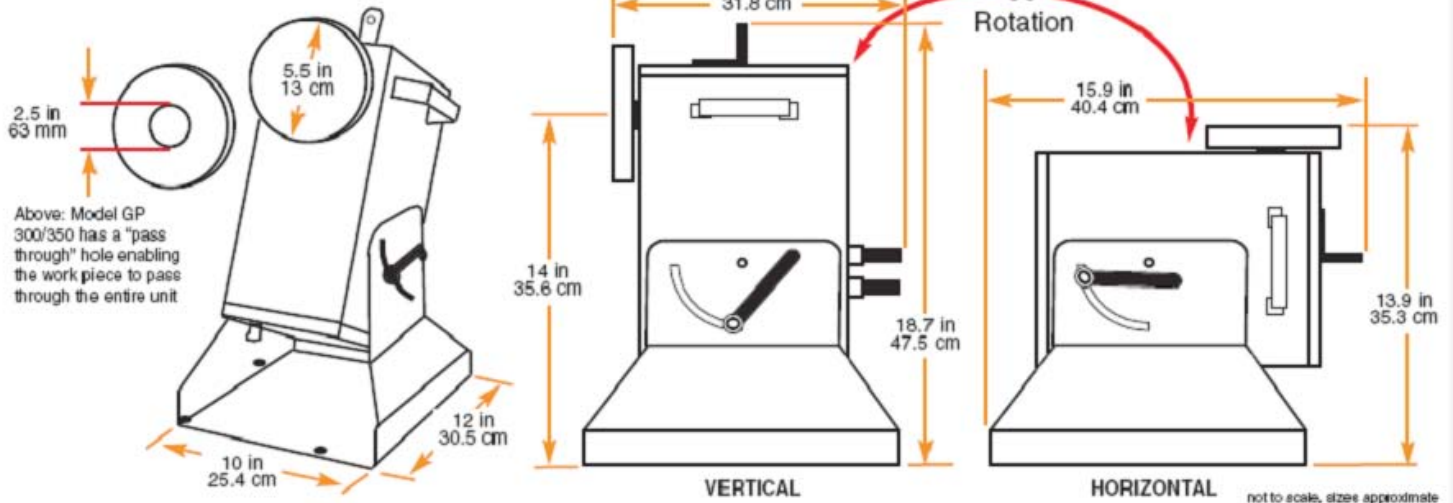

LOAD CAPACITY/SPEEDS

Models:

GP/GPP-(200 & 250)-M and GP (300 & 350)-M

(Speeds 0.27 to 4.63 RPM) 150 lbs. (68 kg) at 3" (76 mm) center of gravity and 3" (76 mm) eccentricity with the table in the vertical position...300 lbs. (136 kg) with the table horizontal.

Models:

GP/GPP-(200 & 250)-H and GP (300 & 350)-H

(Speeds 0.75 to 12.5 RPM) 75 lbs. (34 kg) at 3" (76 mm) center of gravity and 2" (51 mm) eccentricity with the table in the vertical position...150 lbs. (68 kg) with the table horizontal.

TABLE ROTATION

Electronically controlled, infinitely variable in either direction. Positive drive.

TABLE TILT

0° through 90°

ROTATIONAL TORQUE

GP/GPP-(200 & 250)-M and GP (300 & 350)-M 450 inch lbs. (518 kg.cm)

GP/GPP-(200 & 250)-H and GP (300 & 350)-H 150 inch lbs. (172 kg.cm) through the speed range. The maximum allowable eccentricity of "centre of gravity" on the work piece for a given load in inches is calculated as follows.

150 weight of work in lbs. The weight must not exceed the values for overhung load ratings shown below.

Model	Gas Purge	Programmable	Rotational Speed	Vertical Table Loading @ 3" C of G	Horizontal Table Loading
GP-200 & 300-M			0.27 - 4.63 RPM	150 LBS. (68 KG.)	300 LBS. (132 KG.)
GPP-200-M					
GP-250 & 350-M					
GPP-250-M					
GP-200 & 300-H			0.75 - 12.5 RPM	75 LBS. (35 KG.)	150 LBS. (68 KG.)
GPP-200-H					
GP-250 & 350-H					
GPP-250-H					

	(D) Distance		(L) Load	
	IN.	MM.	LBS.	KGS.
	3	76	150	68
	6	152	97	44
	9	229	72	33
	12	305	57	26

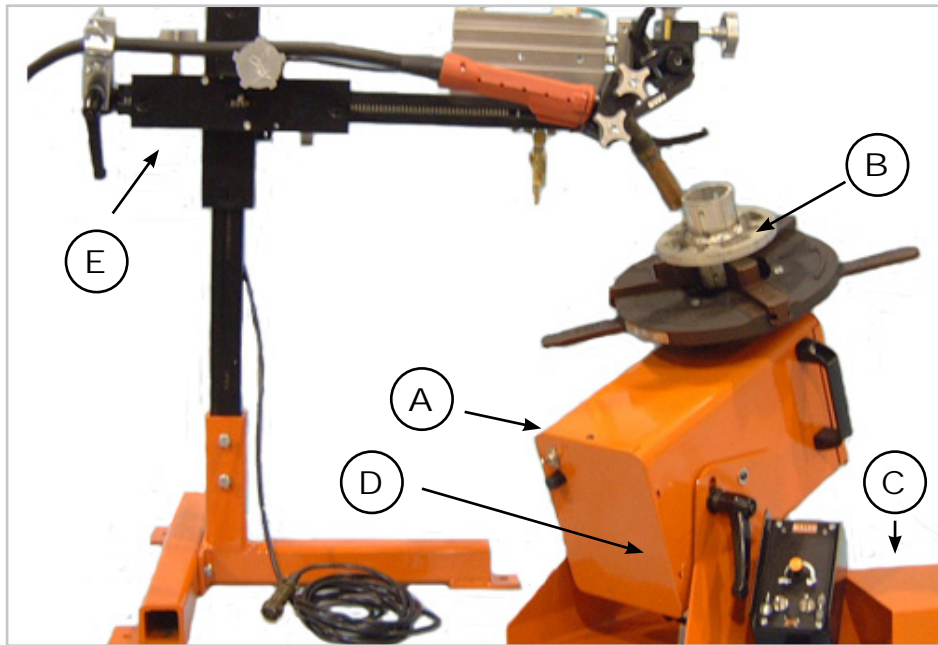

ITEM DESCRIPTION

- A- Welding Positioner
- B- 3 Jaw Gripper
- C- Footswitch Assembly for Manual Operation
- D- Wire-feed / Arc Start Signal Kit
- E- Pneumatic Gun Positioning Assembly

AN ACCURATE AND RELIABLE

AUTOMATIC ROTARY WELD PRODUCTION SYSTEM

FOR A FRACTION OF THE PRICE OF A P.L.C./SERVO SYSTEM.

Gullco's microprocessor control not only provides improved speed regulation to Gullco's proven "GP" range of positioners. It also allows the positioner to be expanded into a fully automated welding cell. The control uses a tach feedback system to ensure smooth and accurate rotation of the workpiece regardless of piece weight and has the ability to activate a pneumatic welding gun holder and wire-feed/arc activation signal, based on an operator defined welding cycle. The programmable microprocessor also provides adjustable positioning timing cycles, amount of weld rotation and weld on/off through 360°.

KAT, KBM, MOGGY, KATBAK & SAM are registered trademarks of Gullco Enterprises Limited

SPECIFICATIONS ARE SUBJECT TO CHANGE WITHOUT NOTICE

Distributed by:

GULLCO		
CANADA - GULLCO INTERNATIONAL LIMITED		
Phone: 905-953-4140	Fax: 905-953-4138	e-mail: sales@gullco.com
U.S.A - GULLCO INTERNATIONAL INC.		
Phone: 440-439-8333	Fax: 440-439-3634	e-mail: ussales@gullco.com
EUROPE - GULLCO INTERNATIONAL (U.K.) LIMITED		
Phone: +44 1257-253579	Fax: +44 1257-254629	e-mail: uksales@gullco.com
AUSTRALIA - GULLCO INTERNATIONAL PTY LIMITED		
Phone: 61 (0)7 3348 5515	Fax: 61 (0)7 3348 5510	e-mail: ausales@gullco.com
INDIA - GULLCO INTERNATIONAL INDIA PVT LIMITED		
Phone: 91-20-6526-0382	Fax: 91-20-2683-6656	e-mail: india.io@gullco.com
CHINA - GULLCO INTERNATIONAL SHANGHAI LIMITED		
Phone: +8621-50460341	Fax: +8621-50463554	e-mail: c.zhang@gullco.com
SINGAPORE - GULLCO INTERNATIONAL LIMITED		
Phone: +65-9385-4468		e-mail: benny.lim@gullco.com
LATIN AMERICA - GULLCO INTERNATIONAL LIMITED		
Phone: 55-11-99485-1336		e-mail: rogerio.macedo@gullco.com
Stuch GmbH & Co. KG Schweisstechnik - GERMANY		
Phone: (02 03) 72 94 95	Fax: (02 03) 72 94 96	e-mail: info@stuch-schweisstechnik.de

SELF-CENTERING WELDING GRIPPER

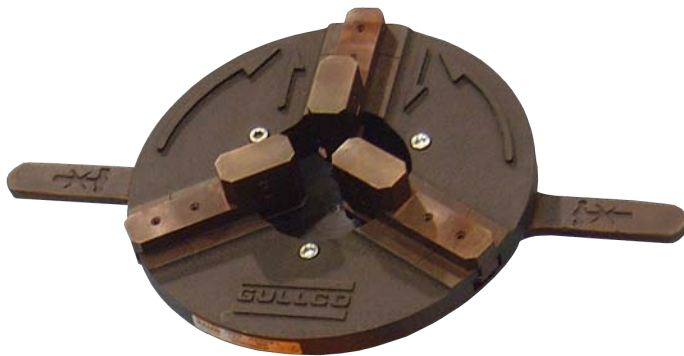

This 3 jaw self-centering gripper is designed for use with all welding positioners including Gullco's GP/GPP-200 Series of positioners. It provides high levels of efficiency and versatility in operations involving welding of fittings, flanges, and small diameter pipe. Specifications are provided on the reverse of this sheet. Contact Gullco or your Gullco distributor for more detailed information.

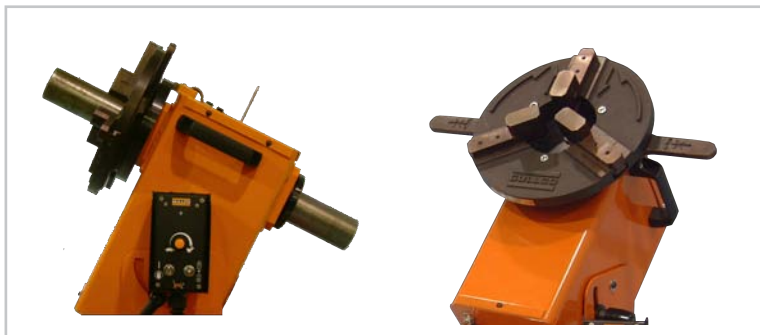

Quickly and easily mounted on any make of positioner, turntable or tailstock using three bolts provided with the gripper.

Self-Centering, fast, smooth close/open action lever to firmly lock or release workpiece.

Durable construction with a slim design, weighing only about half as much as a standard chuck. This feature provides minimal reduction in positioner capacity.

Ideal for the welding of fittings, flanges and small diameter pipe

INCREASE WELD QUALITY AND PRECISION WITH THE SELF-CENTERING GRIPPER FOR WELD POSITIONERS

WELDING AND CUTTING



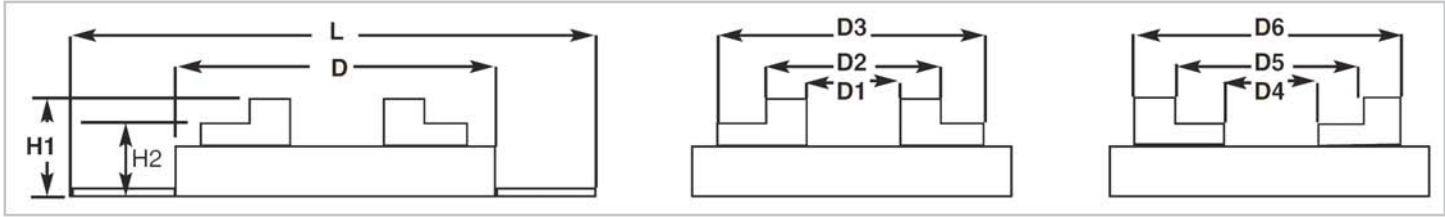

MODEL	DIMENSIONS - Inches - Per Diagram											
	GRIPPER (Inc. Handle)				GRIPPER BODY Clamping Range (min./max.)							WEIGHT
	D	L	H1	H2	D1	D2	D3	D4	D5	D6	LBS	
WPG-250	10.0	17.5	2.75	1.88	0.38 - 6.25	4.25 - 10	9.15 - 15	.38 - 6.25	5.5 - 11.25	9.15 - 15	20	
DIMENSIONS - mm											KG	
WPG-250	254	444	70	48	10 - 159	108 - 254	23 - 381	10 - 159	140 - 286	232 - 381	9	



**Also Available From Gullco
GULLCO MODEL GP/GPP-200
WELDING POSITIONERS**

Capacities up to 150 lbs. (68 kg.) in the vertical position, 300 lbs. (132 kg.)

Horizontal 0.27 to 4.63 rpm rotation and 0.75 to 12.5 rpm in the "H" model
Table tilts any angle 0 - 90°



Table on the Gullco Model GP/GPP-200 Series of Welding Positioners (above left) is designed for mounting the WPG-250 Welding Gripper as indicated.

KAT, KBM, MOGGY, KATBAK & SAM are registered trademarks of Gullco Enterprises Limited

Distributed by:

SPECIFICATIONS ARE SUBJECT TO CHANGE WITHOUT NOTICE. ALL DIMENSIONS ARE NOMINAL



CANADA - GULLCO INTERNATIONAL LIMITED		
Phone: 905-953-4140	Fax: 905-953-4138	e-mail: sales@gullco.com
U.S.A - GULLCO INTERNATIONAL INC.		
Phone: 440-439-8333	Fax: 440-439-3634	e-mail: ussales@gullco.com
EUROPE - GULLCO INTERNATIONAL (U.K.) LIMITED		
Phone: +44 1257-253579	Fax: +44 1257-254629	e-mail: uksales@gullco.com
AUSTRALIA - GULLCO INTERNATIONAL PTY LIMITED		
Phone: 61 (0)7 3348 5515	Fax: 61 (0)7 3348 5510	e-mail: ausales@gullco.com
INDIA - GULLCO INTERNATIONAL INDIA PVT LIMITED		
Phone: 91-20-6526-0382	Fax: 91-20-2683-6656	e-mail: indsales@gullco.com
CHINA - GULLCO INTERNATIONAL SHANGHAI LIMITED		
Phone: +8621-50460341	Fax: +8621-50463554	e-mail: c.zhang@gullco.com
SINGAPORE - GULLCO INTERNATIONAL LIMITED		
Phone: +65-9385-4468		e-mail: benny.lim@gullco.com
LATIN AMERICA - GULLCO INTERNATIONAL LIMITED		
Phone: 55-11-99485-1336		e-mail: rogerio.macedo@gullco.com
Stuch GmbH & Co. KG Schweisstechnik - GERMANY		
Phone: (02 03) 72 94 95	Fax: (02 03) 72 94 96	e-mail: info@stuch-schweisstechnik.de



PLATE EDGE BEVELLING MACHINE - KBM-18®



KBM-18-100

KBM-18® Plate Edge Bevellers - Portable - Self Propelled

These plate bevellers produce clean machined bevels with no thermal distortion on mild steel, stainless steel and aluminum plate from 1/4" (6.0 mm) to 1 1/2" (38.1 mm) thick. Thinner material can be bevelled. Please consult the factory for details. The KBM-18® automatically bevels the topside of the plate which results in a reduction of time and cost. Savings are further enhanced when the KBM-18U® underside plate beveller is used in applications where both sides of the material require beveling.

Adjustable undercarriage for easy height adjustment. The KBM-18® can be purchased with an adjustable height, self-aligning, spring-loaded caster wheel assembly for self-propelled beveling along any length of plate maintaining a uniform bevel and consistent root face. Undercarriage sold separate.

Angle Bevel Pins Enable Bevel Angle Adjustment ... KBM-18® units are supplied with angle bevel pins for 22 1/2°, 30°, 37 1/2°, 45° and 55° bevels. Pins for other bevel angles are available upon request.

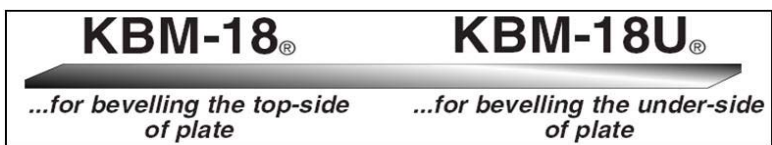

Operates at 10 feet (3 meters) per minute

WITH ADJUSTABLE BEVELLING HEAD TO PRODUCE BEVEL ANGLES 22 1/2° THROUGH 55°





KBM-18-080

HYDRAULIC ADJUSTABLE UNDERCARRIAGE

For easy height adjustment KBM-18® units can be supplied with two types of undercarriage. Both are supplied with Gullco exclusive self-aligning caster wheel assemblies for maintaining a uniform bevel and consistent root face. Undercarriage sold separate



KBM-18-069

CASTER SPRING LOADED ADJUSTABLE UNDERCARRIAGE

Adjustable undercarriages come with Gullco's adjustable height self-aligning spring loaded caster wheel assemblies for self-propelled operation. Best suited for applications where constant machine height is required. The spring-loaded wheels help to eliminate imperfections in the ground to ensure a clean consistent bevel. Sold separate.

Maximum Bevel Width:	0.71" (18.00 mm) at standard 30° bevel angle on material with a tensile strength of 64,000 lb/in 2 (45 Kg/mm2)
Maximum Bevel Depth:	0.61" (15.6 mm) at standard 30° bevel angle on material with a tensile strength of 64,000 lb/in 2 (45 Kg/mm2)
Min. Plate Thickness:	1/4" (6.0mm) Thinner material can be bevelled, consult the factory for details
Max. Plate Thickness:	1 1/2" (38.1 mm)
Bevel Speed:	13' (4 m) per minute*
Motor:	2HP, 3 Phase, available for 230, 460 and 575V~ at 60Hz and also 380 and 400/415V~ at 50Hz supply
Weight:	340 lbs. (154Kg.) including undercarriage assembly
Complies With:	C.S.A./N.R.T.L. (File # LR 35006-6) and C.E. Regulations

KBM-18U® UNDERSIDE BEVELLING

The KBM-18U® is perfect for beveling the underside of the plate without need for flipping the work piece over. Safety is increased as there is no need for constant maneuvering of heavy workloads. Production can further be increased with use of both models simultaneously.



* top speed can vary depending on bevel depth, voltage and frequency fluctuation

KBM-18® comes complete with the following standard equipment:

- 1- KBM-18-X1C Deep Tooth Cutter (medium cut)
- 1- Set Bevel Angle Pins for 22 1/2°, 30°, 37 1/2°, 45° and 55°
- 1- Tool Kit

ACCESORIES AVAILABLE:

- Gullco KBM-18-069 Adjustable Height Undercarriage
- KBM-18-X1C: Medium Tooth Cutter (smooth finish)
- KBM-18-X1H: High Tensile Cutter
- GBM-18 (Specify Degree Required): Angle Bevel Pins for angles other than those supplied as standard)
- GBM-18-0.5: Cutter Shims
- GBM-18-1.0: Cutter Shims

MAXIMUM RECOMMENDED BEVELLING CAPACITIES

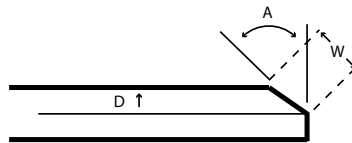

BEVEL ANGLE	TENSILE STRENGTH					
	64,000 lbs/in ² (45 kg/mm ²)		71,000 lbs/in ² (50 kg/mm ²)		85,000 lbs/in ² (60 kg/mm ²)	
A	W	D	W	D	W	D
22 1/2°	0.71" (18 mm)	0.66" (16.6 mm)	0.67" (17 mm)	0.62" (15.7 mm)	0.55" (14 mm)	0.51" (13 mm)
30°	0.71" (18 mm)	0.61" (15.6 mm)	0.59" (15 mm)	0.51" (13 mm)	0.51" (13 mm)	0.44" (11.2 mm)
37 1/2°	0.67" (17 mm)	0.53" (13.5 mm)	0.55" (14 mm)	0.44" (11.1 mm)	0.47" (11.9 mm)	0.37" (9.5 mm)
45°	0.67" (17 mm)	0.47" (12 mm)	0.55" (14 mm)	0.39" (9.9 mm)	0.47" (11.9 mm)	0.33" (8.4 mm)
55°	0.59" (15 mm)	0.34" (8.6 mm)	0.55" (14 mm)	0.32" (8 mm)	0.47" (11.9 mm)	0.27" (6.8 mm)



KBM-18-100
KBM-18-069

KAT, KBM, MOGGY, KATBAK & SAM are registered trademarks of Gullco Enterprises Limited

Distributed by:

SPECIFICATIONS ARE SUBJECT TO CHANGE WITHOUT NOTICE. ALL DIMENSIONS ARE NOMINAL

GULLCO

CANADA - GULLCO INTERNATIONAL LIMITED
Phone: 905-953-4140 Fax: 905-953-4138 e-mail: sales@gullco.com

U.S.A - GULLCO INTERNATIONAL INC.
Phone: 440-439-8333 Fax: 440-439-3634 e-mail: ussales@gullco.com

EUROPE - GULLCO INTERNATIONAL (U.K.) LIMITED
Phone: +44 1257-253579 Fax: +44 1257-254629 e-mail: uksales@gullco.com

AUSTRALIA - GULLCO INTERNATIONAL PTY LIMITED
Phone: 61 (0)7 3348 5515 Fax: 61 (0)7 3348 5510 e-mail: ausales@gullco.com

INDIA - GULLCO INTERNATIONAL INDIA PVT LIMITED
Phone: 91-20-6526-0382 Fax: 91-20-2683-6656 e-mail: indsales@gullco.com

CHINA - GULLCO INTERNATIONAL SHANGHAI LIMITED
Phone: +8621-50460341 Fax: +8621-50463554 e-mail: c.zhang@gullco.com

SINGAPORE - GULLCO INTERNATIONAL LIMITED
Phone: +65-9385-4468 e-mail: benny.lim@gullco.com

LATIN AMERICA - GULLCO INTERNATIONAL LIMITED
Phone: 55-11-99485-1336 e-mail: rogerio.macedo@gullco.com

Stuch GmbH & Co. KG Schweisstechnik - GERMANY
Phone: (02 03) 72 94 95 Fax: (02 03) 72 94 96 e-mail: info@stuch-schweisstechnik.de

UNDERSIDE PLATE BEVELLING MACHINES - KBM-18U®



KBM-18U®

These plate bevellers produce clean machined bevels with no thermal distortion on mild steel, stainless steel and aluminum plate from 1/4" (6.0 mm) to 1 1/2" (38.1 mm) thick. Thinner material can be bevelled. Please consult the factory for details. The KBM-18U® automatically bevels the underside of plate eliminating the need to flip the work piece which results in a reduction of time and cost. Savings are further enhanced when the KBM-18® top-side plate beveller is used in applications where both sides of the material require bevelling.

Adjustable undercarriage for easy height adjustment. The KBM-18U® can be purchased with a hydraulic adjustable height, self-aligning, spring-loaded caster wheel assembly for self-propelled bevelling along any length of plate maintaining a uniform bevel and consistent root face.

Angle bevel Pins...Enable bevel Angle Adjustment kbm-18u® units are supplied with angle bevel pins for 22 1/2°, 30°, 37 1/2°, 45° and 55° bevels. Pins for other bevel angles are available upon request.

KBM-18U®	KBM-18®
...bevelling the under-side of the plate	...bevelling the top-side of the plate

Operates at 10 feet (3 meters) per minute

WITH ADJUSTABLE BEVELLING HEAD TO PRODUCE BEVEL ANGLE 22 1/2° THROUGH 55°





KBM-18-080

HYDRAULIC ADJUSTABLE UNDERCARRIAGE

For easy height adjustment KBM-18U® units can be supplied with two types of undercarriage. both are supplied with gullco exclusive self-aligning caster wheel assemblies to maintaining a uniform bevel and consistent root face. undercarriage sold separate

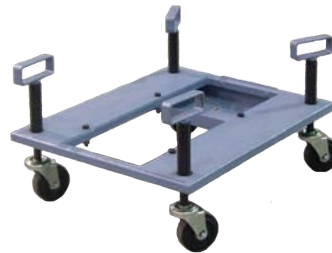

KBM-18-069

CASTER SPRING LOADED ADJUSTABLE UNDERCARRIAGE

Adjustable undercarriages come with gullco's adjustable height, self-aligning spring loaded, caster wheel assemblies for self-propelled operation. best suited for applications where constant machine height is required. The spring-loaded wheels help to eliminate imperfections in the ground to ensure a clean consistent bevel. Sold separate.

Maximum Bevel Width:	0.71" (18.00 mm) at standard 30° bevel angle on material with a tensile strength of 64,000 lb/ in2 (45 kg/mm2)
Maximum Bevel Depth:	0.61" (15.6 mm) at standard 30° bevel angle on material with a tensile strength of 64,000 lb/ in 2 (45 kg/mm2)
Min. Plate Thickness:	1/4" (6.0mm) Thinner material can be bevelled, consult the factory for details
Max. Plate Thickness:	1 1/2" (38.1 mm)
Bevel Speed:	120 in. (304.8 cm) per minute*
Motor:	2 hP, 3 Phase, available for 230, 460 and 575v~ at 60hz and also 380 and 400/415v~ at 50hz supply
Weight:	340 lbs. (154 kg.) including undercarriage assembly
Complies With:	C.S.A./n.r.T.I. (File # Ir 35006-6) and C.E. regulations

* top speed can vary depending on bevel depth, voltage and frequency fluctuation

KBM-18® comes complete with the following standard equipment:

- 1- KBM-18-X1C Deep Tooth Cutter (Medium Cut)
- 1- Set bevel Angle Pins for 22 1/2°, 30°, 37 1/2°, 45° and 55°
- 1- Tool kit

KBM-18® TOPSIDE BEVELLER

The KBM-18® is perfect for beveling the topside of the plate without need for flipping the work piece over. Safety is increased as there is no need for constant maneuvering of heavy workloads. Production can further be increased with use of both models simultaneously.



AccESoriES AvAiilABle:

- KBM-18-069 Adjustable Height Undercarriage
- KBM-18-X1C: Medium Tooth Cutter (smooth finish)
- KBM-18-X1H: high Tensile cutter
- GBM-18 (Specify degree required): Angle bevel Pins for angles other than those supplied as standard)
- GBM-18-0.5: Cutter Shims
- GBM-18-1.0: Cutter Shims

MAXIMUM RECOMMENDED BEVELLING CAPACITY

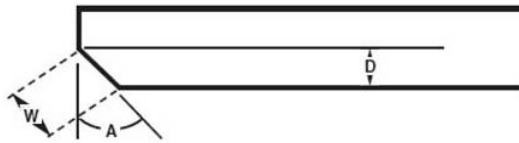

BEVEL ANGLE	TENSILE STRENGTH					
	64,000 lbs/in ² (45 kg/mm ²)		71,000 lbs/in ² (50 kg/mm ²)		85,000 lbs/in ² (60 kg/mm ²)	
A	W	D	W	D	W	D
22 1/2°	0.71" (18 mm)	0.66" (16.6 mm)	0.67" (17 mm)	0.62" (15.7 mm)	0.55" (14 mm)	0.51" (13 mm)
30°	0.71" (18 mm)	0.61" (15.6 mm)	0.59" (15 mm)	0.51" (13 mm)	0.51" (13 mm)	0.44" (11.2 mm)
37 1/2°	0.67" (17 mm)	0.53" (13.5 mm)	0.55" (14 mm)	0.44" (11.1 mm)	0.47" (11.9 mm)	0.37" (9.5 mm)
45°	0.67" (17 mm)	0.47" (12 mm)	0.55" (14 mm)	0.39" (9.9 mm)	0.47" (11.9 mm)	0.33" (8.4 mm)
55°	0.59" (15 mm)	0.34" (8.6 mm)	0.55" (14 mm)	0.32" (8 mm)	0.47" (11.9 mm)	0.27" (6.8 mm)



KAT, KBM, MOGGY, KATBAK & SAM are registered trademarks of Gullco Enterprises limited

Distributed by:

SPECIFICATIONS ARE SUBJECT TO CHANGE WITHOUT NOTICE. ALL DIMENSIONS ARE NOMINAL

GULLCO

CANADA - GULLCO INTERNATIONAL LIMITED
 Phone: 905-953-4140 Fax: 905-953-4138 e-mail: sales@gullco.com

U.S.A - GULLCO INTERNATIONAL INC.
 Phone: 440-439-8333 Fax: 440-439-3634 e-mail: ussales@gullco.com

EUROPE - GULLCO INTERNATIONAL (U.K.) LIMITED
 Phone: +44 1257-253579 Fax: +44 1257-254629 e-mail: uksales@gullco.com

AUSTRALIA - GULLCO INTERNATIONAL PTY LIMITED
 Phone: 61 (0)7 3348 5515 Fax: 61 (0)7 3348 5510 e-mail: ausales@gullco.com

INDIA - GULLCO INTERNATIONAL INDIA PVT LIMITED
 Phone: 91-20-6526-0382 Fax: 91-20-2683-6656 e-mail: indsales@gullco.com

CHINA - GULLCO INTERNATIONAL SHANGHAI LIMITED
 Phone: +8621-50460341 Fax: +8621-50463554 e-mail: c.zhang@gullco.com

SINGAPORE - GULLCO INTERNATIONAL LIMITED
 Phone: +65-9385-4468 e-mail: benny.lim@gullco.com

LATIN AMERICA - GULLCO INTERNATIONAL LIMITED
 Phone: 55-11-99485-1336 e-mail: rogerio.macedo@gullco.com

Stuch GmbH & Co. KG Schweisstechnik - GERMANY
 Phone: (02 03) 72 94 95 Fax: (02 03) 72 94 96 e-mail: info@stuch-schweisstechnik.de



PLATE BEVELLING MACHINE - HEAVY DUTY KBM-28®



KBM-28-100

KBM-28® Plate Edge Beveller -
Heavy Duty - Portable - Self-Propelled - No Noise

KBM-28® Bevellers produce clean machined bevels with no thermal distortion on mild steel, stainless steel and aluminum plate from 5/16" (8.0 mm) to 2" (50.0 mm) thick. The KBM-28® automatically bevels the top-side of the plate reducing time and cost. Savings are further enhanced when the KBM-28U® underside beveller is used in applications where both sides of the plate require beveling.

This portable plate beveller has an adjustable undercarriage for easy height adjustment. The KBM-28® units can be purchased with Gullco's exclusive adjustable height, self-aligning, spring-loaded caster wheel assembly for self-propelled beveling along any length of plate which helps to maintaining a uniform bevel and consistent root face. Sold separate

Angle bevel pins enable bevel angle adjustments
The KBM-28® units are supplied with angle bevel pins for 22 1/2°, 30°, 37 1/2°, 45° and 55° bevels. Pins for other bevel angles are available upon request.

KBM-28®	KBM-28U®
...for beveling the top-side of plate	...for beveling the under-side of plate

Operates at 6.5 feet (2 meters) per minute

WITH ADJUSTABLE BEVELLING HEAD TO PRODUCE BEVEL ANGLES 22 1/2° THROUGH 55°

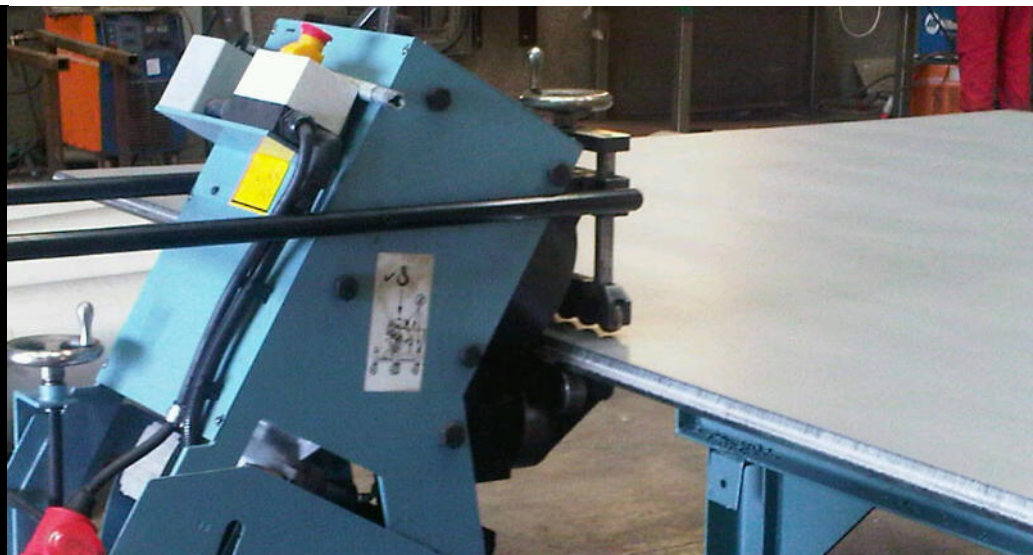



KBM-28-080

HYDRAULIC ADJUSTABLE UNDERCARRIAGE

For easy height adjustment KBM-28® units can be supplied with two types of undercarriages. Both are supplied with Gullco exclusive self-aligning caster wheel assemblies for self-propelled bevelling along the length of the plate, maintaining a uniform bevel and consistent root face. Undercarriage sold separate

KBM-28U® UNDERSIDE BEVELLER

The KBM-28U® is perfect for bevelling the underside of the plate without need for flipping the work piece over. In combination with the KBM-28® efficiency is greatly increased when bevelling both the top and bottom of the plate.



Accessories available:

- KBM-28-X1C: Medium Tooth Cutter (smooth finish)
- KBM-28-X1H: High Tensile Cutter
- GBM-28 (Specify Degree Required): Angle Bevel Pins for angles other than those supplied as standard
- GBM-28-0.5: Cutter Shims
- GBM-28-1.0: Cutter Shims
- KBM-28-080: Hydraulic Undercarriage

Maximum Bevel Width:	1.10" (28.00 mm) at standard 30° bevel angle on material with a tensile strength of 64,000 lb/in ² (45 Kg/mm ²)
Maximum Bevel Depth:	0.95" (24.2 mm) at standard 30° bevel angle on material with a tensile strength of 64,000 lb/in ² (45 Kg/mm ²)
Min. Plate Thickness:	5/16" (8.0 mm)
Max. Plate Thickness:	2" (50.0 mm)
Bevel Speed:	78.7" (200 cm) per minute*
Motor:	3 HP, 3 phase, available for 230, 460 and 575V~ at 60Hz and also 380 and 400/415V~ at 50Hz supply
Weight:	979 lbs. (444Kg.) including undercarriage assembly
Complies With:	C.S.A./N.R.T.L. (File # LR 35006-6) and C.E. Regulations

* Top speed can vary depending on bevel depth, voltage and frequency fluctuation

KBM-28® comes complete with the following standard equipment:
 1- KBM-28-X1C Cutter (medium cut)
 1- Set Bevel Angle Pins for 22 1/2°, 30°, 37 1/2°, 45° and 55°
 1- Tool Kit

MAXIMUM RECOMMENDED BEVELLING CAPACITIES

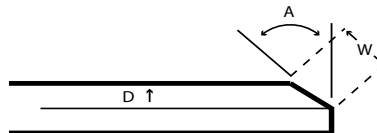

BEVEL ANGLE	TENSILE STRENGTH					
	64,000 lbs/in ² (45 kg/mm ²)		71,000 lbs/in ² (50 kg/mm ²)		85,000 lbs/in ² (60 kg/mm ²)	
A	W	D	W	D	W	D
22 1/2°	1.10" (28 mm)	1.02" (26 mm)	1.02" (26 mm)	0.95" (24 mm)	0.91" (23 mm)	0.84" (21.3 mm)
30°	1.10" (28 mm)	0.95" (24.2 mm)	0.98 (25 mm)	0.85 (21.6 mm)	0.89" (22.5 mm)	0.77" (19.5 mm)
37 1/2°	1.06" (27 mm)	0.84" (21.4 mm)	0.98" (25 mm)	0.78" (19.8 mm)	0.83" (21 mm)	0.66" (16.7 mm)
45°	1.02" (26 mm)	0.72" (18.4 mm)	0.94" (24 mm)	0.67" (17 mm)	0.83" (21 mm)	0.58" (14.9 mm)
55°	0.98" (25 mm)	0.56" (14.3 mm)	0.91" (23 mm)	0.52" (13.2 mm)	0.83" (21 mm)	0.47" (12 mm)



KAT, KBM, MOGGY, KATBAK & SAM are registered trademarks of Gullco Enterprises Limited

Distributed by:

SPECIFICATIONS ARE SUBJECT TO CHANGE WITHOUT NOTICE. ALL DIMENSIONS ARE NOMINAL

GULLCO

CANADA - GULLCO INTERNATIONAL LIMITED
 Phone: 905-953-4140 Fax: 905-953-4138 e-mail: sales@gullco.com

U.S.A - GULLCO INTERNATIONAL INC.
 Phone: 440-439-8333 Fax: 440-439-3634 e-mail: ussales@gullco.com

EUROPE - GULLCO INTERNATIONAL (U.K.) LIMITED
 Phone: +44 1257-253579 Fax: +44 1257-254629 e-mail: uksales@gullco.com

AUSTRALIA - GULLCO INTERNATIONAL PTY LIMITED
 Phone: 61 (0)7 3348 5515 Fax: 61 (0)7 3348 5510 e-mail: ausales@gullco.com

INDIA - GULLCO INTERNATIONAL INDIA PVT LIMITED
 Phone: 91-20-6526-0382 Fax: 91-20-2683-6656 e-mail: indsales@gullco.com

CHINA - GULLCO INTERNATIONAL SHANGHAI LIMITED
 Phone: +8621-50460341 Fax: +8621-50463554 e-mail: c.zhang@gullco.com

SINGAPORE - GULLCO INTERNATIONAL LIMITED
 Phone: +65-9385-4468 e-mail: benny.lim@gullco.com

LATIN AMERICA - GULLCO INTERNATIONAL LIMITED
 Phone: 55-11-99485-1336 e-mail: rogerio.macedo@gullco.com

Stuch GmbH & Co. KG Schweisstechnik - GERMANY
 Phone: (02 03) 72 94 95 Fax: (02 03) 72 94 96 e-mail: info@stuch-schweisstechnik.de



UNDERSIDE PLATE BEVELLING MACHINE - KBM-28U®



KBM-28U®

KBM-28U® Underside Plate Edge Beveller - Heavy Duty

These Plate Bevelers produce clean machined bevels with no thermal distortion on mild steel, stainless steel and aluminum plate from 5/16" (8.0 mm) to 2" (50.0 mm) thick. The KBM-28U® bevels the underside of the plate eliminating the need to flip the workpiece which results in a reduction of time and cost. Savings are further enhanced when both topside and underside units are used when both sides of a work piece require beveling.

Adjustable undercarriages for easy height adjustment. The KBM-28U® units can be purchased with Gullco's hydraulic adjustable height, self-aligning undercarriage for self-propelled beveling along any length of plate maintaining a uniform bevel and consistent root face. Sold separate

Bevel Angle Adjustment Pins...
KBM-28U® units are supplied with angle bevel pins for 22 1/2°, 30°, 37 1/2°, 45° and 55° bevels. Pins for other bevel angles are available upon request.

KBM-28U ®	KBM-28 ®
<i>... bevelling the under-side of plate</i>	<i>... bevelling the top-side of plate</i>

Operates at 6.5 feet (2 meters) per minute

WITH ADJUSTABLE BEVELLING HEAD TO PRODUCE BEVEL ANGLES 22 1/2° THROUGH 55°





KBM-28-080

HYDRAULIC ADJUSTABLE UNDERCARRIAGE

For easy height adjustment KBM-28U® units can be supplied with an undercarriage. This undercarriage uses Gullco exclusive self-aligning caster wheel assemblies for self-propelled bevelling along the length of the plate, maintaining a uniform bevel and consistent root face. Undercarriage sold separate.

KBM-28-100

The KBM-28® is perfect for bevelling the topside of the plate without need for flipping the work piece over. In combination with the KBM-28U® efficiency is greatly increased when bevelling both the top and bottom of the plate.



Maximum Bevel Width:	1.10" (28.00 mm) at standard 30° bevel angle on material with a tensile strength of 64,000 lb/in2 (45 Kg/mm2)
Maximum Bevel Depth:	0.95" (24.2 mm) at standard 30° bevel angle on material with a tensile strength of 64,000 lb/in2 (45 Kg/mm2)
Min. Plate Thickness:	5/16" (8.0 mm)
Max. Plate Thickness:	2" (50.0 mm)
Bevel Speed:	78.7" (200 cm) per minute*
Motor:	3 HP, 3 phase, available for 230, 460 and 575V~ at 60Hz and also 380 and 400/415V~ at 50Hz supply
Weight:	890 lbs. (404Kg.) including undercarriage assembly
Complies With:	C.S.A./N.R.T.L. (File # LR 35006-6) and C.E. Regulations

* Top speed can vary depending on bevel depth, voltage and frequency fluctuation

KBM-28U® comes complete with the following standard equipment:

- 1- KBM-28-X1C Cutter (medium cut)
- 1- Set Bevel Angle Pins for 22 1/2°, 30°, 37 1/2°, 45° and 55°
- 1- Tool Kit



Accessories available:

- KBM-28-X1C: Medium Tooth Cutter (smooth finish)
- KBM-28-X1H: High Tensile Cutter
- GBM-28 (Specify Degree Required): Angle Bevel Pins for angles other than those supplied as standard
- GBM-28-0.5: Cutter Shims
- GBM-28-1.0: Cutter Shims
- KBM-28-080: Hydraulic Undercarriage
- KBM-28-002: Adjustable Undercarriage

MAXIMUM RECOMMENDED BEVELLING CAPACITIES

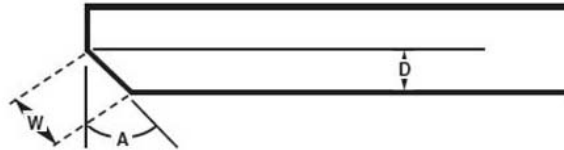

BEVEL ANGLE	TENSILE STRENGTH					
	64,000 lbs/in ² (45 kg/mm ²)		71,000 lbs/in ² (50 kg/mm ²)		85,000 lbs/in ² (60 kg/mm ²)	
A	W	D	W	D	W	D
22 1/2°	1.10" (28 mm)	1.02" (26 mm)	1.02" (26 mm)	0.95" (24 mm)	0.91" (23 mm)	0.84" (21.3 mm)
30°	1.10" (28 mm)	0.95" (24.2 mm)	0.98" (25 mm)	0.85" (21.6 mm)	0.89" (22.5 mm)	0.77" (19.5 mm)
37 1/2°	1.06" (27 mm)	0.84" (21.4 mm)	0.98" (25 mm)	0.78" (19.8 mm)	0.83" (21 mm)	0.66" (16.7 mm)
45°	1.02" (26 mm)	0.72" (18.4 mm)	0.94" (24 mm)	0.67" (17 mm)	0.83" (21 mm)	0.58" (14.9 mm)
55°	0.98" (25 mm)	0.56" (14.3 mm)	0.91" (23 mm)	0.52" (13.2 mm)	0.83" (21 mm)	0.47" (12 mm)



KAT, KBM, MOGGY, KATBAK & SAM are registered trademarks of Gullco Enterprises Limited

Distributed by:

SPECIFICATIONS ARE SUBJECT TO CHANGE WITHOUT NOTICE. ALL DIMENSIONS ARE NOMINAL



CANADA - GULLCO INTERNATIONAL LIMITED Phone: 905-953-4140 Fax: 905-953-4138 e-mail: sales@gullco.com
U.S.A - GULLCO INTERNATIONAL INC. Phone: 440-439-8333 Fax: 440-439-3634 e-mail: ussales@gullco.com
EUROPE - GULLCO INTERNATIONAL (U.K.) LIMITED Phone: +44 1257-253579 Fax: +44 1257-254629 e-mail: uksales@gullco.com
AUSTRALIA - GULLCO INTERNATIONAL PTY LIMITED Phone: 61 (0)7 3348 5515 Fax: 61 (0)7 3348 5510 e-mail: ausales@gullco.com
INDIA - GULLCO INTERNATIONAL INDIA PVT LIMITED Phone: 91-20-6526-0382 Fax: 91-20-2683-6656 e-mail: indsales@gullco.com
CHINA - GULLCO INTERNATIONAL SHANGHAI LIMITED Phone: +8621-50460341 Fax: +8621-50463554 e-mail: c.zhang@gullco.com
SINGAPORE - GULLCO INTERNATIONAL LIMITED Phone: +65-9385-4468 e-mail: benny.lim@gullco.com
LATIN AMERICA - GULLCO INTERNATIONAL LIMITED Phone: 55-11-99485-1336 e-mail: rogerio.macedo@gullco.com
Stuch GmbH & Co. KG Schweistechnik - GERMANY Phone: (02 03) 72 94 95 Fax: (02 03) 72 94 96 e-mail: info@stuch-schweisstechnik.de



KBM BEVELS ALUMINIUM

Portable beveler replaces large plainer

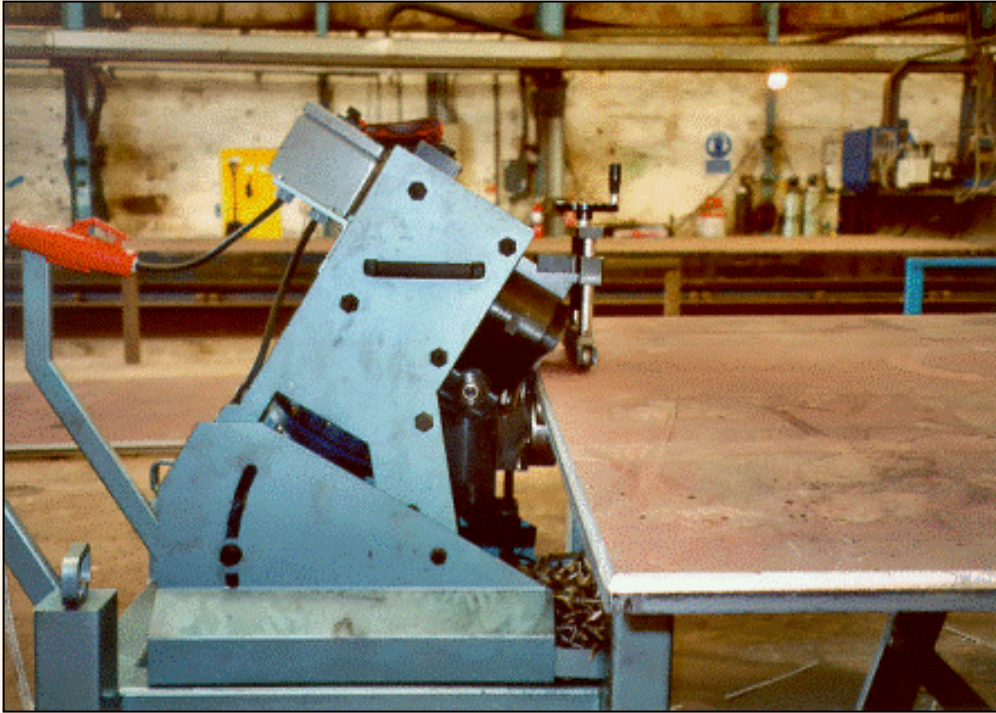

The Gullco International customer does plenty of plate beveling heavy plates, 5254 and 5654 aluminum, typically 10x30 feet x1/2 inch weighing 2,100 pounds, go into the manufacture of railroad tank cars. After plasmas tank cutting to shape, the plate requires a 30° bevel with a 1/16 inch land on all four edges. Then wire brushes clean 12 inches back from beveled edges, a bending machines rolls the plate into cylinders, nine feet in diameter. GMAW guns on booms weld the cylinders in flat position.

With the seam on the bottom, machines weld one pass at a current of 310 to 320 amps on the beveled side. The guns move at 10 to 14 in./ min. to weld longitudinal seams. Then, with guns stationary, the cylinders rotate to make circumferential welds. Milling backchips the joint to solid weld metal for the final pass, laid in at 340 to 360 amps from the outside of the cylinder. Fillers: 5654 or 5254 aluminum plate and 5356 or 5554 (depending on customer specification) for 5454 plate. X-rays inspect all tank car cylinder welds. Faced with overhaul of its large beveling plainer, at a cost of \$50 000 to \$80 000 the customer found that it could improve operations . Two small portable bevellers now on the line in place of the plainer have doubled the rate of plate edge beveling at the plant.

With the plainer, an overhead crane rotated the plate, and fixtures held it in place for beveling all four edges of each plate. Fixturing difficulties caused uneven bevels, resulting in excessive weld repair. The new way is easier and gives better results. The plate lies flat on stands at a height set for the beveling machine. The operator rolls the caster spring-loaded wheel assembly over to the work piece, clamps it to the plate edge, and starts the motor. The machine bevels plate as it moves along to make a consistent smooth, clean bevel. No more repositioning of the plate. With the increased beveling rate on the plate line, the new machines can bevel plate in other departments. They can cut a 22.5° or 55° bevel on aluminum, mild steel, or stainless steel plate.

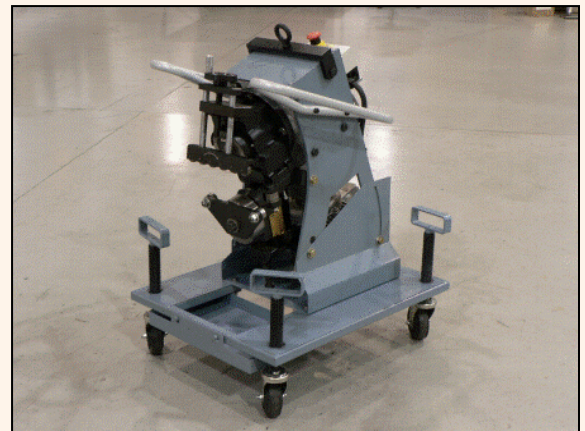



KBM Bevels Titanium

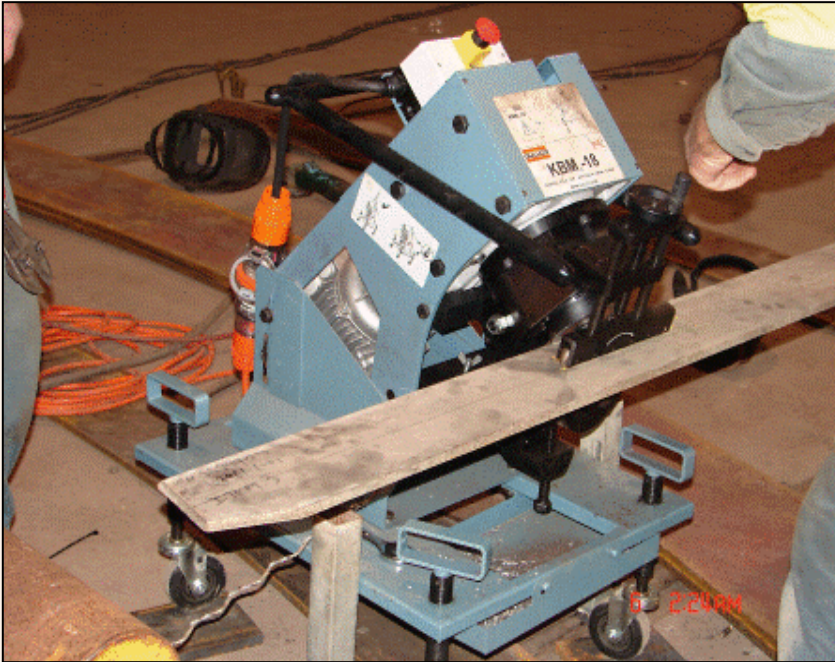

Small portable bevelers have enjoyed success replacing larger planing machines and flame cutting equipment for beveling of aluminum, and low carbon steel. Recently a company based out of Ohio gave one of these small machines a tough new assignment beveling of titanium plate. The firm fabricates ASME Code vessels of titanium, zirconium and tantalum. Most of the vessels go to petroleum processing plants.

In the past the heavy section titanium plate would be sent to an outside vendor where an open side planing machine would bevel the plate edges. The company would also take part in some in house flame cutting where operators would flame cut thick sections. This operation left a heat affected zone and grinders had to remove heat-affected metal. Plate farmed out for beveling added cost of handling, shipping and purchased machine time.

When the company put the KBM to the test on the heavy titanium the high speed portable plate edge beveler proved its worth. The beveler immediately got to work and has earned steady duty there at the factory. It machines clean cuts in titanium, taking over work formerly done by flame cutting, outside machining and nibbling in sections. The biggest benefit other than the greatly reduced production cost is that KBM bevelers eliminate heat distortion which results in a more quality weld.

Beveling with the Gullco machine is quick and easy. An operator wheels the machine to the work piece and with spring loaded castor wheel assemblies the beveling machine will accommodate for any uneven surface making for a clean machined bevel every time.



KAT, KBM, MOGGY, KATBAK & SAM are registered trademarks of Gullco Enterprises Limited

SPECIFICATIONS ARE SUBJECT TO CHANGE WITHOUT NOTICE

Distributed by:

WWW.GULLCO.COM

GULLCO

CANADA - GULLCO INTERNATIONAL LIMITED
 Phone: 905-953-4140 Fax: 905-953-4138 e-mail: sales@gullco.com

U.S.A - GULLCO INTERNATIONAL INC.
 Phone: 440-439-8333 Fax: 440-439-3634 e-mail: ussales@gullco.com

EUROPE - GULLCO INTERNATIONAL (U.K.) LIMITED
 Phone: +44 1257-253579 Fax: +44 1257-254629 e-mail: uksales@gullco.com

AUSTRALIA - GULLCO INTERNATIONAL PTY LIMITED
 Phone: 61 (0)7 3348 5515 Fax: 61 (0)7 3348 5510 e-mail: ausales@gullco.com

INDIA - GULLCO INTERNATIONAL INDIA PVT LIMITED
 Phone: 91-20-6526-0382 Fax: 91-20-2683-6656 e-mail: indsales@gullco.com

CHINA - GULLCO INTERNATIONAL SHANGHAI LIMITED
 Phone: +8621-50460341 Fax: +8621-50463554 e-mail: c.zhang@gullco.com

SINGAPORE - GULLCO INTERNATIONAL LIMITED
 Phone: +65-9385-4468 e-mail: benny.lim@gullco.com

LATIN AMERICA - GULLCO INTERNATIONAL LIMITED
 Phone: 55-11-99485-1336 e-mail: rogerio.macedo@gullco.com

Stuch GmbH & Co. KG Schweisstechnik - GERMANY
 Phone: (02 03) 72 94 95 Fax: (02 03) 72 94 96 e-mail: info@stuch-schweisstechnik.de



WELDING ELECTRODE DRYING OVENS



Compact In-Shop Models...



...Portable Models



Eliminate the risk of costly rework and rejects.

Ensure consistent physical properties and x-ray quality welds.

Protect low hydrogen quality in electrode and flux-core wire.

Protect coatings on aluminum, bronze, cast iron stainless and other electrodes.

Improve weld consistency and reduce cost

MAINTAIN CONSISTENT WELD ELECTRODE PROPERTIES TO INSURE HIGH QUALITY WELDS



THE PORTABLES....

They're lightweight, durable and completely portable, easy to load, easy to carry, ready to provide low cost control of welding quality in the shop or in the field. Reduce operating costs by providing your welding operators with fast access to electrodes at the point of work. There's a model exactly suited for your requirements.



Thermometer #1029-8

8" Thermometer

For use with the portable oven models 10 A-20 and 10B-20. Fits securely into the standard oven rod lifter.

20 LB. CAPACITY PORTABLES

MODEL 10A-20

Operates from any 115 volt, AC/DC source, is equipped with rod lifter, pilot light and has 1" high false bottom to prevent moisture damage to electric connections. The oven temperature, not controlled by thermostat, average 275° F and provides absolute electrode stability when used in conjunction with temperature controlled ovens.

MODEL 10B-20

Operates on 115 volt, AC only. Has rod lifters, pilot light, and thermostat that maintains oven temperature in 100° F to 300° F range, providing independent control of electrode welding quality.



70 lbs CAPACITY PORTABLES

MODEL 50

This handy portable oven, only 23" high and 11" in diameter, gives fast access to up to 50 lbs of stabilized rods in the shop or in the field. It operates on 115 volt, AC. Thermostatic control maintains oven temperature in the 100° - 300°F range. High performance / efficiency feature include:

- Central calrod element ensures uniform distribution of heat in oven
- a full 2 inches of insulation surrounds oven wall
- Equipped with two separate rod lifters to give the welding operator fast access to different rod types

...AND COMPACT, IN SHOP MODELS



Model 125
- for operation on
115 or 220 Volt, AC.



Model 350
- for operation on 115 or
220 Volt, AC



These Gullco Stabilizing Ovens have gained international recognition and acceptance based on a variety of quality performance features including:

- Compact, modular design with controls recessed for protection.
- Shelves easily removed to accommodate large size loads.
- Oven fully insulated to prevent heat loss and a pilot light indicates oven operation.
- Thermostat control, incorporating on/off switch, maintains oven temperature in 100° - 550° F range.
- Model 125 and 350 feature nesting feet and sockets for safe, easy stacking.

**Compact
and
Stackable**

**HIGH
TEMP
TO
605°F
AVAILABLE
ON
MOST
MODELS**



Model 1000
- for operation on 220/440 Volt, AC

**1000 Lb. CAPACITY HIGH
TEMPERATURE ELECTRODE
RE-BAKING AND STABILIZING OVEN**



...available in two Models - one equipped with an Indicating Control System and the other with an Electronic Digital Programmer and Controller.

Custom configured palletized multi-compartment OVENS

Do your specs involve different temperatures or bake times?

Gullco has a configuration to suit your needs!



Thermometer Accessory-
Model T23 - Thermometer with amounting bracket and screw for front mounting on the Model 125 and 350 ovens.

SPECIFICATIONS

	PORTABLE OVENS			COMPACT IN-SHOP MODELS		
	10 A-20	10 B-20	50	125	350	1000
Capacity	10 to 20 lbs.		50 to 70 lbs.	125 to 175 lbs.	350 to 400 lbs.	Sixteen 12" Spools / 1000 lbs.
Outside Dimensions	7" dia. X 23" high		11" dia. X 23" high	16"H x 16"W x 24 1/2"D	22"H x 22"W x 24 1/2"D	39 3/4"H x 30 1/4"W x 30 3/4"D
Inside Dimensions	3" dia. X 19" high		7" dia. X 19" high	8 1/4"H x 9 3/4"W x 19"D	14"H x 16"W x 19"D	24"H x 21 3/4"W x 24"D
Unit Weight (approx.)	14 lbs.		32 lbs.	58 lbs.	58 lbs.	330 lbs.
Electrode Size	up to 18"		up to 18"	up to 18"	up to 18"	up to 24"
Line Cord	3 wire - 8 ft.		3 wire - 8 ft.	3 wire - 8 ft.	3 wire - 8 ft. None	None
Element	100W - 115Volt	125W - 115Volts	300W - 115 Volt	1000W - 115 Volts	1500W - 115V or 220V	3000W - 220/440 V-1 Phase
Thermostat	No	Yes	Yes	Yes	Yes	Yes
Pilot Light	Yes		Yes	Yes	Yes	Yes
Temp. Range	Av. 275° F	100° - 400° F	100° - 400° F	100° - 550° F	100° - 550° F	100° - 550° F
Door Latch	Lift Lid		Lift Lid	Push / Pull	Push / Pull	Push / Pull
Stacking	No		No	Yes	Yes	Yes

All specifications are subject to change without notice

Note: Weight capacity depends on electrode length

AND FOR FLUX CONDITIONING AND CONTROL...

FLUX HOPPERS AND HOLDING OVENS

The 100 lb. capacity hopper and 600 lb. capacity holding oven illustrated at right are just part of a complete range of flux conditioning / control units available from Gullco. All ovens are equipped with low watt density elements to maintain uniform temperature through the flux load. All hoppers and holders are designed to assure that the most stringent flux specifications are maintained.



KAT, KBM, MOGGY, KATBAK & SAM are registered trademarks of Gullco Enterprises Limited

Distributed by:

SPECIFICATIONS ARE SUBJECT TO CHANGE WITHOUT NOTICE. ALL DIMENSIONS ARE NOMINAL

GULLCO

CANADA - GULLCO INTERNATIONAL LIMITED
 Phone: 905-953-4140 Fax: 905-953-4138 e-mail: sales@gullco.com

U.S.A - GULLCO INTERNATIONAL INC.
 Phone: 440-439-8333 Fax: 440-439-3634 e-mail: ussales@gullco.com

EUROPE - GULLCO INTERNATIONAL (U.K.) LIMITED
 Phone: +44 1257-253579 Fax: +44 1257-254629 e-mail: uksales@gullco.com

AUSTRALIA - GULLCO INTERNATIONAL PTY LIMITED
 Phone: 61 (0)7 3348 5515 Fax: 61 (0)7 3348 5510 e-mail: ausales@gullco.com

INDIA - GULLCO INTERNATIONAL INDIA PVT LIMITED
 Phone: 91-20-6526-0382 Fax: 91-20-2683-6656 e-mail: indsales@gullco.com

CHINA - GULLCO INTERNATIONAL SHANGHAI LIMITED
 Phone: +8621-50460341 Fax: +8621-50463554 e-mail: c.zhang@gullco.com

SINGAPORE - GULLCO INTERNATIONAL LIMITED
 Phone: +65-9385-4468 e-mail: benny.lim@gullco.com

LATIN AMERICA - GULLCO INTERNATIONAL LIMITED
 Phone: 55-11-99485-1336 e-mail: rogerio.macedo@gullco.com

Stuch GmbH & Co. KG Schweisstechnik - GERMANY
 Phone: (02 03) 72 94 95 Fax: (02 03) 72 94 96 e-mail: info@stuch-schweisstechnik.de



WELDING ELECTRODE DRYING OVENS



Compact In-Shop Models...



...Portable Models



Eliminate the risk of costly rework and rejects.

Ensure consistent physical properties and x-ray quality welds.

Protect low hydrogen quality in electrode and flux-core wire.

Protect coatings on aluminum, bronze, cast iron stainless and other electrodes.

Improve weld consistency and reduce cost

MAINTAIN CONSISTENT WELD ELECTRODE PROPERTIES TO INSURE HIGH QUALITY WELDS



THE PORTABLES.... They're lightweight, durable and completely portable, easy to load, easy to carry, ready to provide low cost control of welding quality in the shop or in the field. Reduce operating costs by providing your welding operators with fast access to electrodes at the point of work. There's a model exactly suited for your requirements.



Thermometer #1029-8

8" Thermometer

For use with the portable oven models 10 A-20 and 10B-20. Fits securely into standard oven rod lifter

9KG. CAPACITY PORTABLES

MODEL 10 A-20

Operates from any 115 volt, AC/DC source, is equipped with rod lifter, pilot light and has 25.4 mm high false bottom to prevent moisture damage to electric connections. The oven temperature, not controlled by thermostat, averages 135° C and provides absolute electrode stability when used in conjunction with temperature controlled ovens.

MODEL 10 B-20

Operates on 115 or 220 volt, AC only. Has rod lifters, pilot light, and thermostat that maintains oven temperature in 38° C to 204° C range, providing independent control of electrode welding quality.



31.75 kg. CAPACITY PORTABLES

MODEL 50

This handy portable oven, only 584mm high and 280mm in diameter, gives fast access to up to 22.7 kg. of stabilized rods in the shop or in the field. It operates on 115 volt, AC. Thermostatic control maintains oven temperature in the 38° to 204° C range. High performance / efficiency feature include:

- Central calrod element ensures uniform distribution of heat in the oven
- a full 51 mm inches of insulation surround the ovens walls
- Equipped with two separate rod lifters to give the welding operator fast access to different rod types

...AND COMPACT, IN SHOP MODELS



Model 125

- for operation on
115 or 220 Volt, AC.



Model 350

- for operation on 115 or
220 Volt, AC



These Gullco Stabilizing Ovens have gained international recognition and acceptance based on a variety of quality performance features including:

- Compact, modular design with controls recessed for protection.
- Shelves easily removed to accommodate large size loads.
- Oven fully insulated to prevent heat loss and a pilot light indicates oven operation.
- Thermostat control, incorporating on/off switch, maintains oven temperature in 38° - 288° C range.
- Model 125 and 350 feature nesting feet and sockets for safe, easy stacking.

**Compact
and
Stackable**

**HIGH
TEMP
TO
313°C
AVAILABLE
ON
MOST
MODELS**



Model 1000

- for operation on 220/440 Volt, AC

**454 kg. CAPACITY HIGH
TEMPERATURE ELECTRODE
RE-BAKING AND STABILIZING OVEN**

Custom configured palletized multi-compartment OVENS

Do your specs
involve different
temperatures or
bake times?

Gullco has a
configuration to
suit your needs!



...available in two Models - one equipped
with an Indicating Control System and the
other with an Electronic Digital Programmer
and Controller.

Thermometer Accessory-

Model T23 - Thermometer with amounting bracket and screw for front mounting on the Model 125 and 350 ovens.

SPECIFICATIONS

	PORTABLE OVENS			COMPACT IN-SHOP MODELS		
	10 A-20	10 B-20	50	125	350	1000
Capacity	9 kg.		31 kg.	57 kg.	159 kg.	454 kg.
Outside Dimensions	178mm Dia x 585mm High		279 D x 584 H	407 W x 407 H x 622 L	559 W x 559 H x 622 L	768 W x 1016 H x 768 L
Inside Dimensions	76mm Dia. x 483mm High		177 dia. X 483 high	248 W x 209 H x 482 L	405 W x 356 H x 482 L	552 W x 610 H x 610 L
Unit Weight (approx.)	7 kg.		16 kg.	27 kg.	50 kg.	150 kg.
Electrode Size	up to 457mm		up to 457mm	up to 457mm	up to 457mm	up to 457mm
Line Cord	2428mm		2428mm	2428mm	2428mm None	None
Element	100W - 115Volt	125W - 115Volts	300W - 115 Volt	1000W - 115 Volts	1500W - 115V or 220V	3000W - 220/440 V-1 Phase
Thermostat	No	Yes	Yes	Yes	Yes	Yes
Pilot Light	Yes		Yes	Yes	Yes	Yes
Temp. Range	135° C	38° - 148° C	38° - 148° C	38° - 228° C	38° - 288° C	38° - 288° C
Door Latch	Lift Lid		Lift Lid	Push / Pull	Push / Pull	Push / Pull
Stacking	No		No	Yes	Yes	Yes

All specifications are subject to change without notice

Note: Weight capacity depends on electrode length

AND FOR FLUX CONDITIONING AND CONTROL...

FLUX HOPPERS AND HOLDING OVENS

The 45 kg. capacity hopper and 272 kg. capacity holding oven illustrated at right are just part of a complete range of flux conditioning / control units available from Gullco. All ovens are equipped with low watt density elements to maintain uniform temperature through the flux load. All hoppers and holders are designed to assure that the most stringent flux specifications are maintained.



KAT, KBM, MOGGY, KATBAK & SAM are registered trademarks of Gullco Enterprises Limited

Distributed by:

SPECIFICATIONS ARE SUBJECT TO CHANGE WITHOUT NOTICE. ALL DIMENSIONS ARE NOMINAL

GULLCO		
CANADA - GULLCO INTERNATIONAL LIMITED		
Phone: 905-953-4140	Fax: 905-953-4138	e-mail: sales@gullco.com
U.S.A - GULLCO INTERNATIONAL INC.		
Phone: 440-439-8333	Fax: 440-439-3634	e-mail: ussales@gullco.com
EUROPE - GULLCO INTERNATIONAL (U.K.) LIMITED		
Phone: +44 1257-253579	Fax: +44 1257-254629	e-mail: uksales@gullco.com
AUSTRALIA - GULLCO INTERNATIONAL PTY LIMITED		
Phone: 61 (0)7 3348 5515	Fax: 61 (0)7 3348 5510	e-mail: ausales@gullco.com
INDIA - GULLCO INTERNATIONAL INDIA PVT LIMITED		
Phone: 91-20-6526-0382	Fax: 91-20-2683-6656	e-mail: indsales@gullco.com
CHINA - GULLCO INTERNATIONAL SHANGHAI LIMITED		
Phone: +8621-50460341	Fax: +8621-50463554	e-mail: c.zhang@gullco.com
SINGAPORE - GULLCO INTERNATIONAL LIMITED		
Phone: +65-9385-4468		e-mail: benny.lim@gullco.com
LATIN AMERICA - GULLCO INTERNATIONAL LIMITED		
Phone: 55-11-99485-1336		e-mail: rogerio.macedo@gullco.com
Stuch GmbH & Co. KG Schweisstechnik - GERMANY		
Phone: (02 03) 72 94 95	Fax: (02 03) 72 94 96	e-mail: info@stuch-schweisstechnik.de

WWW.GULLCO.COM

OV-11-01-M

WELD FLUX HOPPERS AND REBAKE OVENS



Flux Holding Ovens

Flux Rebake Ovens

Maintain critical flux specifications with precise temperature control

Utilizes low watt density elements to allow for accurate uniform temperature control

Flux Hopper and Rebake Ovens for Submerged Arc Welding

FLUX HOPPERS AND FLUX HOLDING OVENS ASSURE FLUX SPECIFICATIONS ARE MAINTAINED



FLUX HOPPERS

100 lb. HOPPER

MODEL GOV 100 FH:

This 100 lb. Capacity Flux Hopper is designed for mounting either directly above the welding head or on the welding manipulator to maintain the flux in its original dry state. It is complete with mountings lugs, lift-off loading lid, thermometer, flux level window, flux screen and a flux heating system incorporating 40 watts of low density elements. The temperature is controlled by a thermostat. The temperature range is 100° to 400° F. All for operation on 115 / 230 volts, 50/60 cycle AC power supply. Weight 27 lbs.

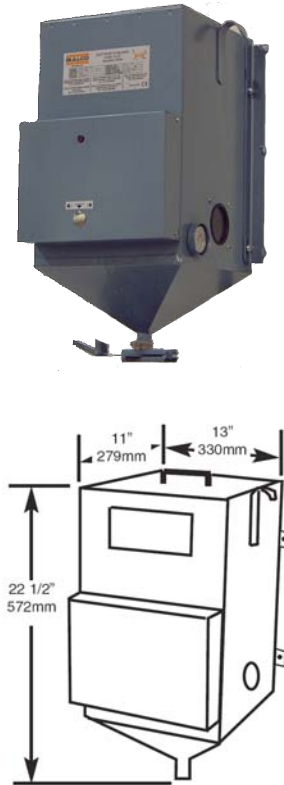

FLUX HOLDING OVENS

MODEL GOV 100 PFD:

This portable 100 lb. capacity Flux Holding Oven uses the same flux hopper as Model GOV 100 FH except it is supplied complete with a portable carrier, a 25 lb. capacity flux bucket for transfer of the flux to the welding head. Flux bucket gravity feed from a positive lever type valve at the base of the Hopper. The 100 lb. Hopper can be readily detached from its portable carrier and mounted directly above the welding head or on the welding manipulator. All for operation on 115 / 230 volts, 50/60 cycle AC power supply. Weight 50 lb.



SUBMERGED ARC MOGGY

MODEL GM-02

This SAM® trackless welding carriage can be equipped to produce precision, quality submerged arc or MIG welds. It is guided by adjustable horizontal guide roller assemblies which maintain a set distance from a vertical member or a unique optional "handled" steering device. The unit comes complete with a removable attachment post that holds a wire feed head, flux hopper & valve (submerged arc unit only), wire spool, controls and adjustable weld positioning brackets with horizontal and vertical slides that enable full positioning of the weld gun either behind or beside the carriage.

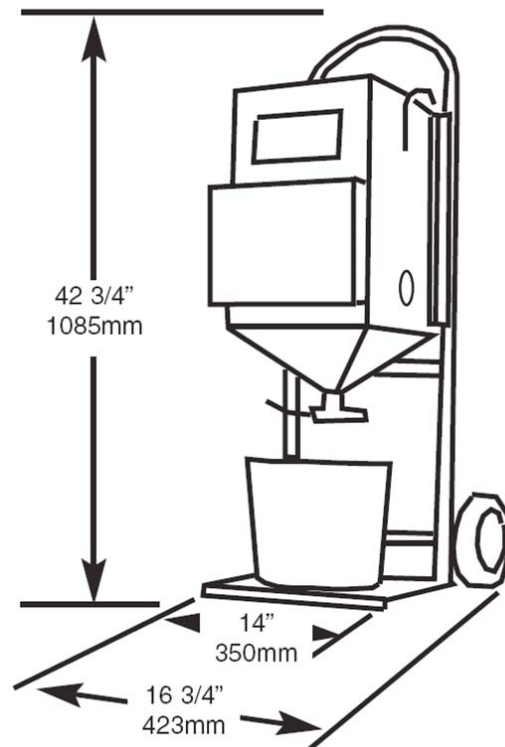

200 LB. HOLDING OVEN

MODEL GOV 200 FD:

This insulated 200 lb. capacity Flux Holding Oven is generally located in the storage area and is used to keep the flux in its dry state or to dry out flux that has picked up moisture. It is complete with lifting lugs, and hinged loading lid, thermometer and a flux heating system incorporating 1500 watts of low density elements. The temperature is controlled by a thermostat. The temperature range is 100° to 550°F. All for operation on 115 / 230 volts, 50/60 cycle AC power supply. Weight 155 lbs.

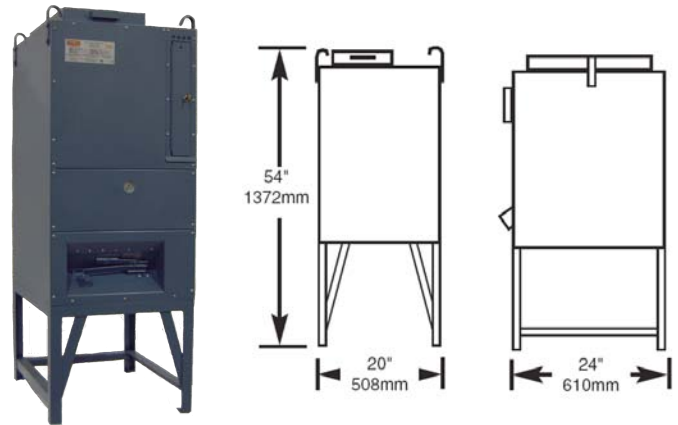

600 LB. HOLDING OVENS

MODEL GOV 600 FD3:

This fully insulated 600 lb. capacity Flux Oven incorporates three (3) individual 200 lb. hoppers, enabling up to three (3) different types of flux to be stored and dried simultaneously. It is complete with three (3) individual thermometers and a flux heating system incorporating 4500 watts of low density elements. Temperature is controlled by three (3) individual thermostats so that each hopper is individually controlled. Temperature range 100° to 550°F. All for operation on 220 / 415 volt, 3 phase AC power supply. Weight 250 lb.

NOTE: All above Ovens can be supplied for operation on 220 volts or 440 volts, single phase power supply. Please consult with manufacturing.



600 LB FLUX BAKE OVEN Model GOV 600 FDH:

This fully insulated 600 lb. capacity high temperature Flux Bake Oven is similar in design to the above Model GOV 600 FD3, except incorporating high temperature insulation, high temperature wiring and the flux heating system which incorporates 11,400 watts of low density elements. Temperature range 100° to 850°F. Each hopper controlled by an individual thermostat to provide individual temperature control. All for operation on 220, 440 or 575 volts, 3 phase power supply. Weight 350 lb. *

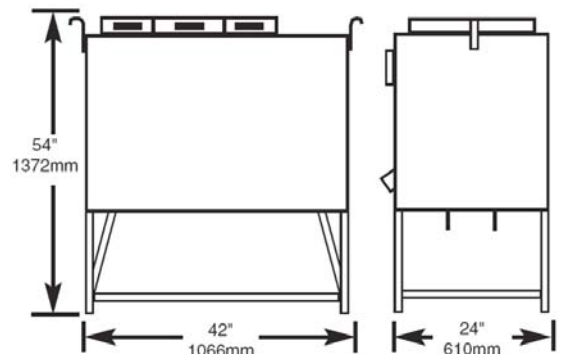

* Voltage must be specified at time of placing order

THE MOST COMPLETE RANGE OF STABILIZING OVENS

PORTABLE WELDING OVENS

These electrode ovens are lightweight but durable. The design makes this oven model easy to carry and easy to load. The welding ovens provide low cost control of welding quality in the shop or at the job site.

Available in 20 lb. capacity and 50 lb. capacity models.

MODEL 350



MODEL 125



MODEL 50
50 lb Capacity
Electrode oven with
handle and wheel
assembly for easier
portability



MODEL 10A-20

WELDING OVENS: COMPACT IN-SHOP MODELS

The in-shop models are designed to maintain electrode integrity at a higher temperature range. All in-shop models have a recessed control panel for protection as well as removable shelves and thermostat control. These models are available in 125 lb., 350 lb. and 1000 lb. capacities.

1000 POUND CAPACITY HIGH TEMPERATURE ELECTRODE RE-BAKING STABILIZING OVEN

Available in two models, one equipped with an Indicating Control System and the other with an Electronic Digital Programmer Controller.



KAT, KBM, MOGGY, KATBAK & SAM are registered trademarks of Gullco Enterprises Limited

Distributed by:

SPECIFICATIONS ARE SUBJECT TO CHANGE WITHOUT NOTICE. ALL DIMENSIONS ARE NOMINAL

GULLCO

CANADA - GULLCO INTERNATIONAL LIMITED
Phone: 905-953-4140 Fax: 905-953-4138 e-mail: sales@gullco.com

U.S.A - GULLCO INTERNATIONAL INC.
Phone: 440-439-8333 Fax: 440-439-3634 e-mail: ussales@gullco.com

EUROPE - GULLCO INTERNATIONAL (U.K.) LIMITED
Phone: +44 1257-253579 Fax: +44 1257-254629 e-mail: uksales@gullco.com

AUSTRALIA - GULLCO INTERNATIONAL PTY LIMITED
Phone: 61 (0)7 3348 5515 Fax: 61 (0)7 3348 5510 e-mail: ausales@gullco.com

INDIA - GULLCO INTERNATIONAL INDIA PVT LIMITED
Phone: 91-20-6526-0382 Fax: 91-20-2683-6656 e-mail: indsales@gullco.com

CHINA - GULLCO INTERNATIONAL SHANGHAI LIMITED
Phone: +8621-50460341 Fax: +8621-50463554 e-mail: c.zhang@gullco.com

SINGAPORE - GULLCO INTERNATIONAL LIMITED
Phone: +65-9385-4468 e-mail: benny.lim@gullco.com

LATIN AMERICA - GULLCO INTERNATIONAL LIMITED
Phone: 55-11-99485-1336 e-mail: rogerio.macedo@gullco.com

Stuch GmbH & Co. KG Schweisstechnik - GERMANY
Phone: (02 03) 72 94 95 Fax: (02 03) 72 94 96 e-mail: info@stuch-schweisstechnik.de